

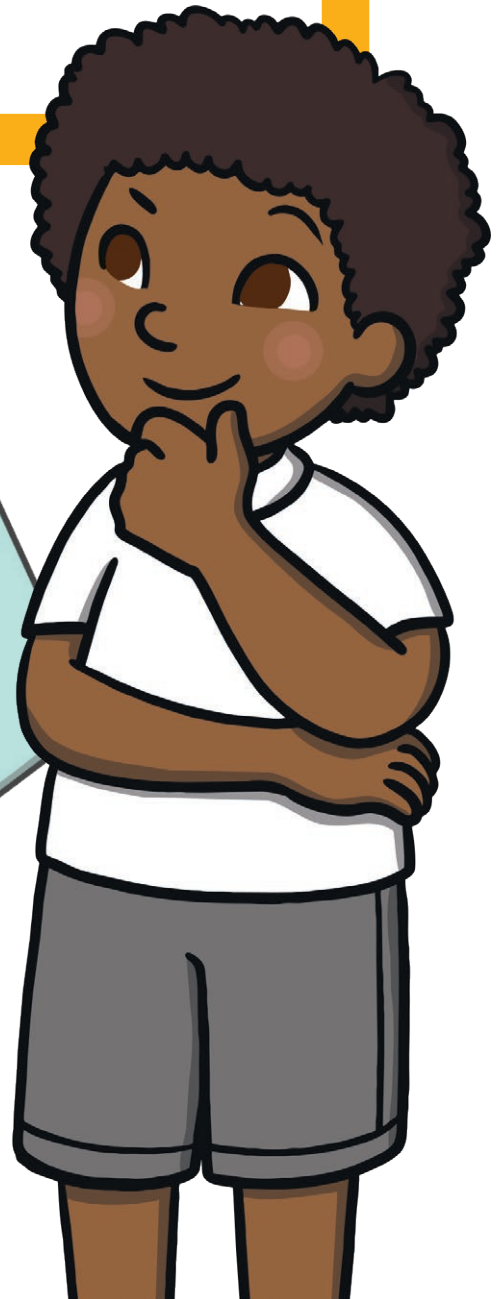

My 3D Shapes Activity Booklet

Name:

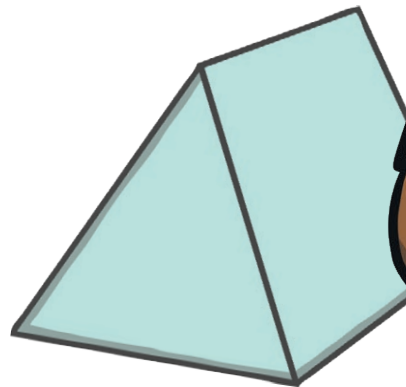
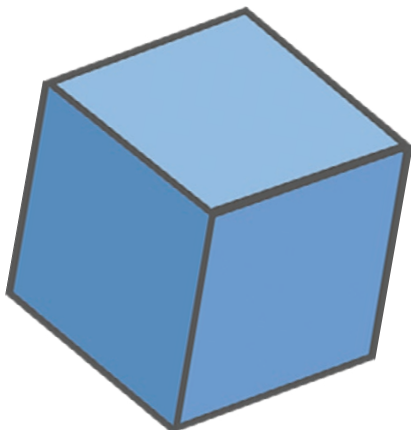
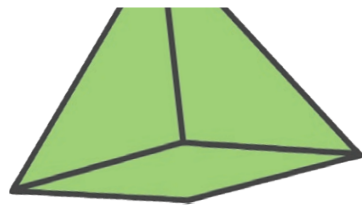
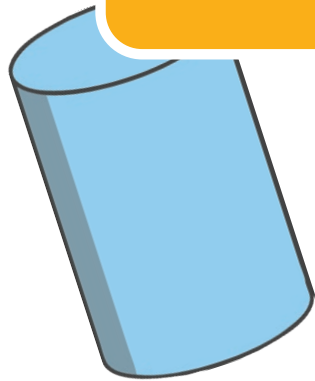

3D Shape Colouring

Use the key to colour in the 3D shapes correctly.

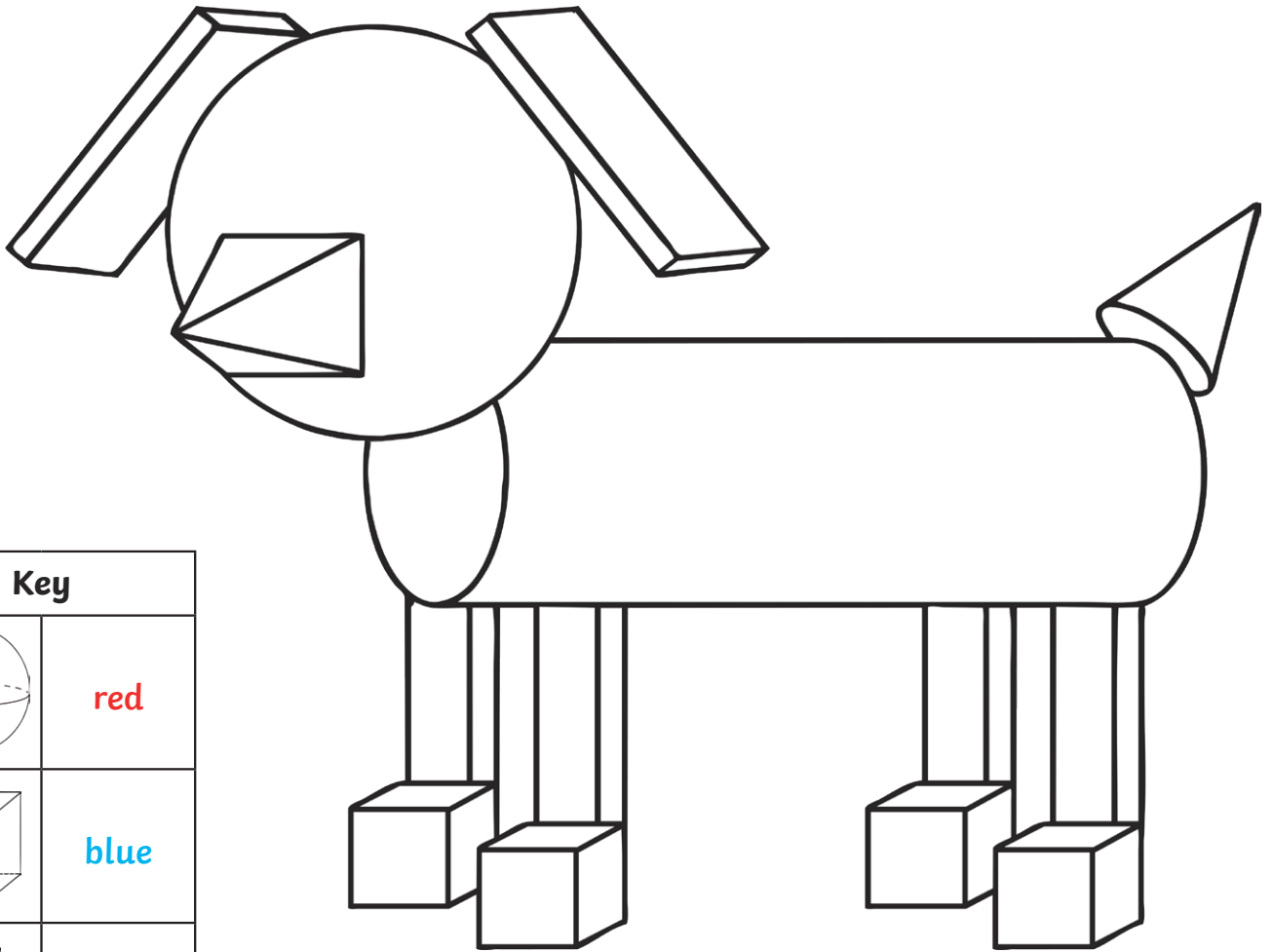

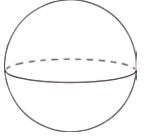
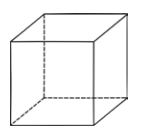
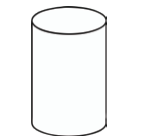
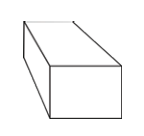
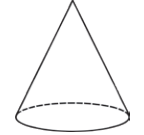
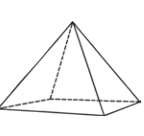
Key	
	red
	blue
	green
	purple
	orange
	yellow

3D Shape Colouring

Use the key to colour in the 3D shapes correctly.

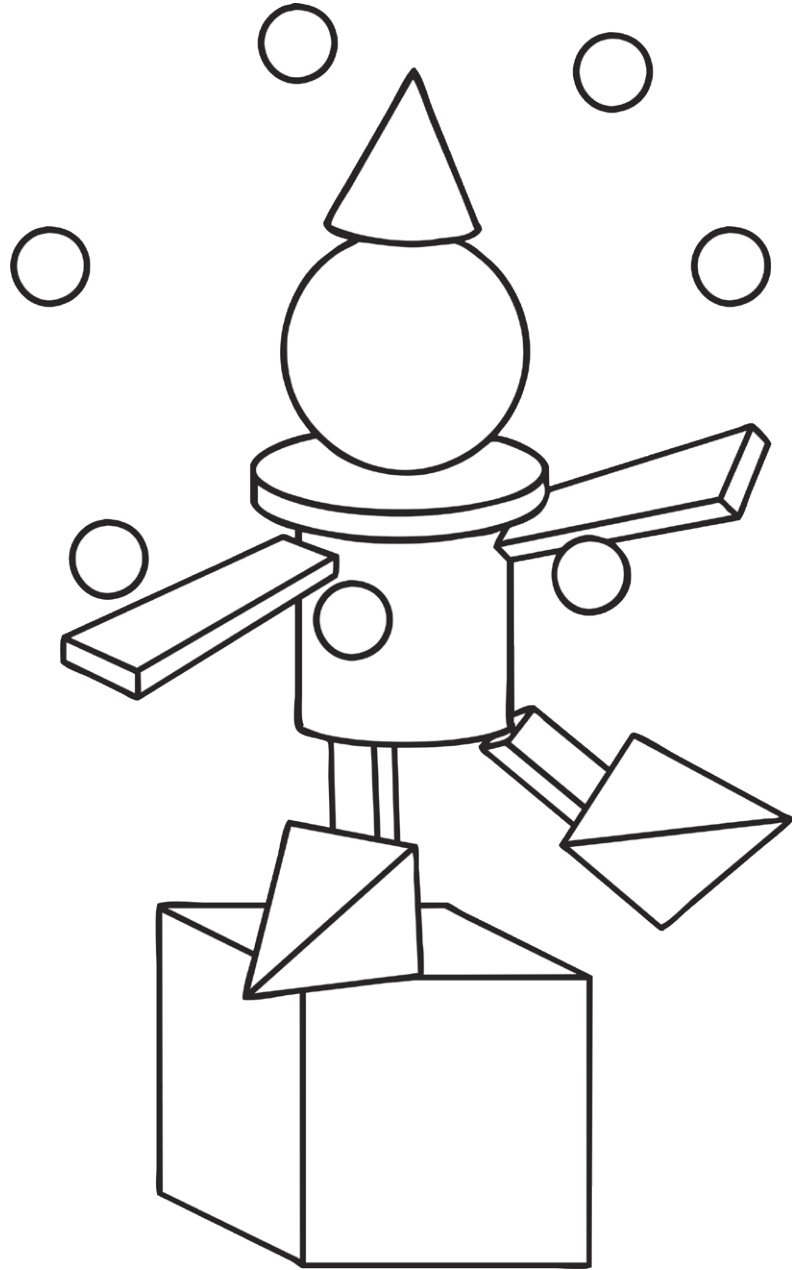

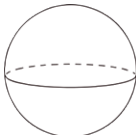
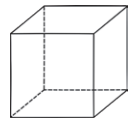
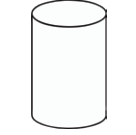
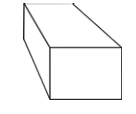
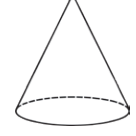
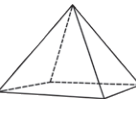
Key	
	red
	blue
	green
	purple
	orange
	yellow

3D Shapes

I Spy and Count to 10

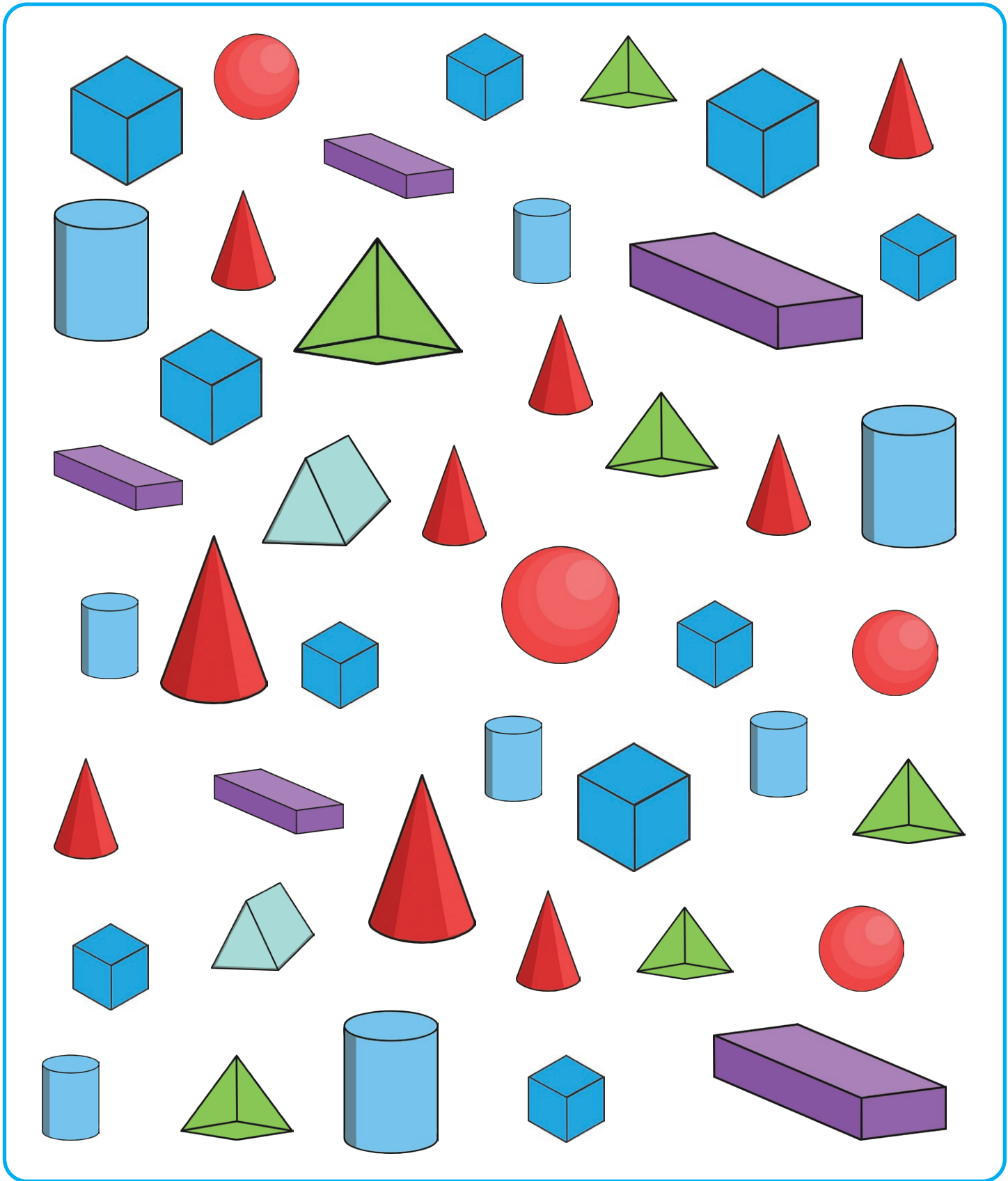

3D Shapes

I Spy and Count to 10 Checklist

Count the number of each type of 3D shape and write the numeral in the box.

cubes

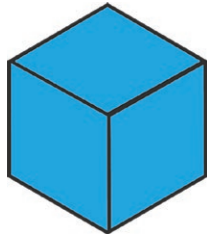

spheres

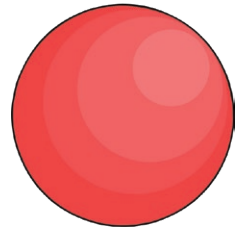

cuboids

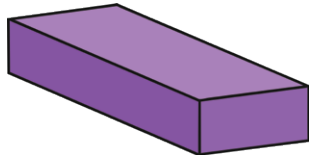

triangular
prisms

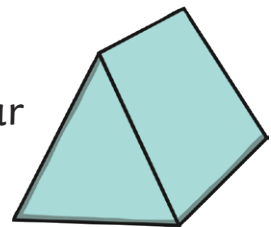

cylinders

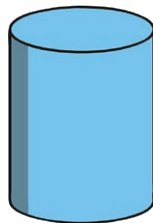

pyramids

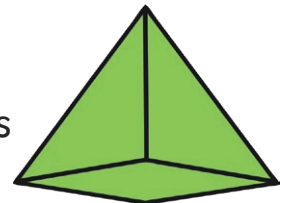

cones

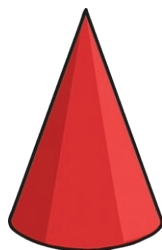

3D Shape Names

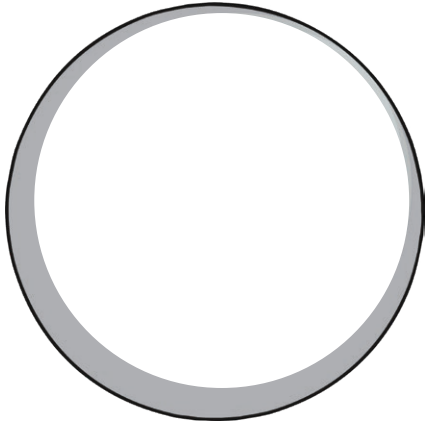

sphere

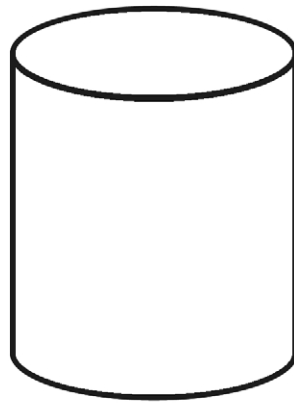

cylinder

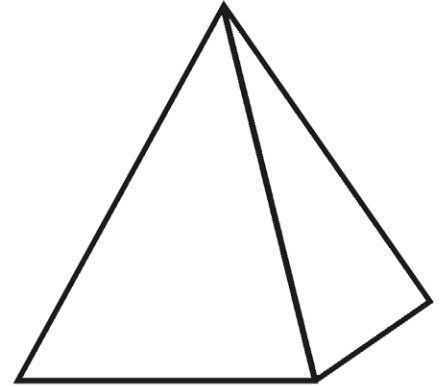

pyramid

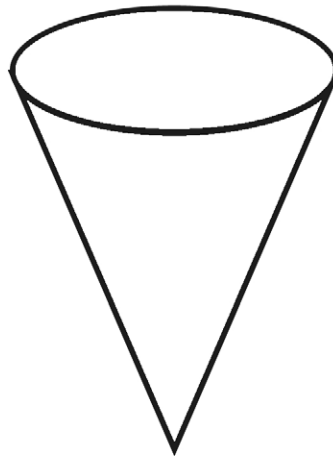

cone

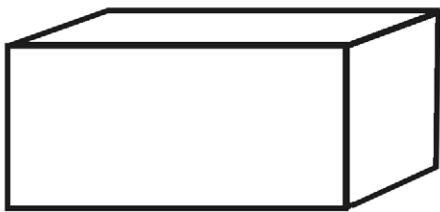

cuboid

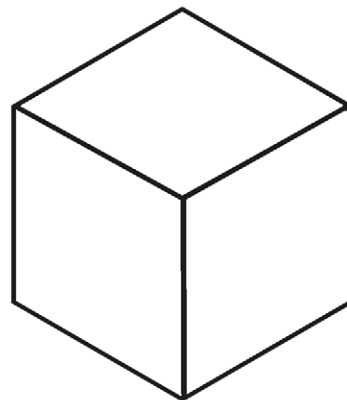

cube

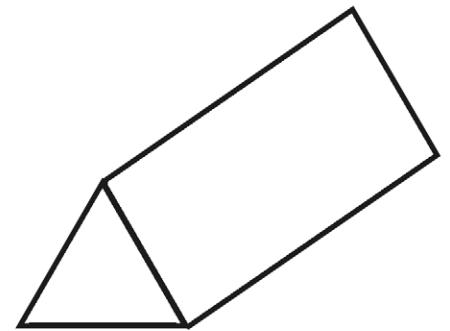

**triangular
prism**

Cube Shape

Cube

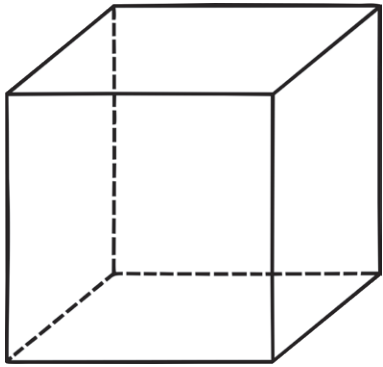

Trace

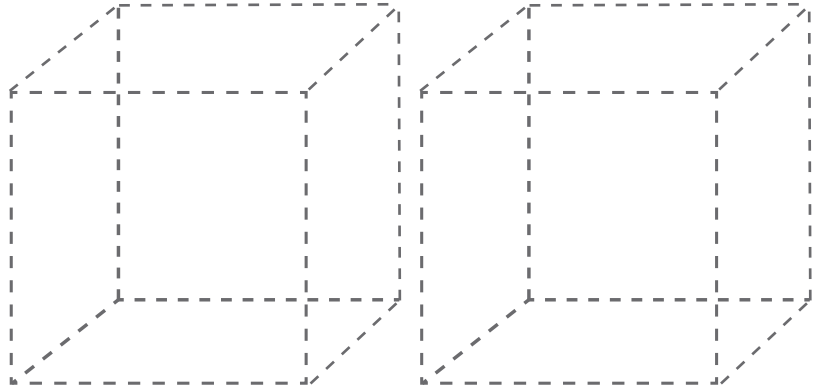

Colour in

CUBE

Stick the cubes in the correct size order.

Colour in all the cubes.

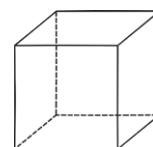
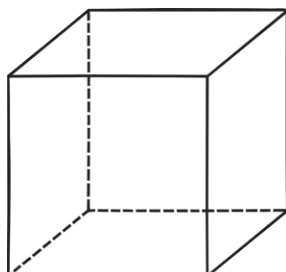
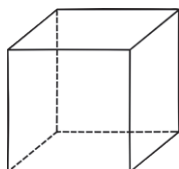
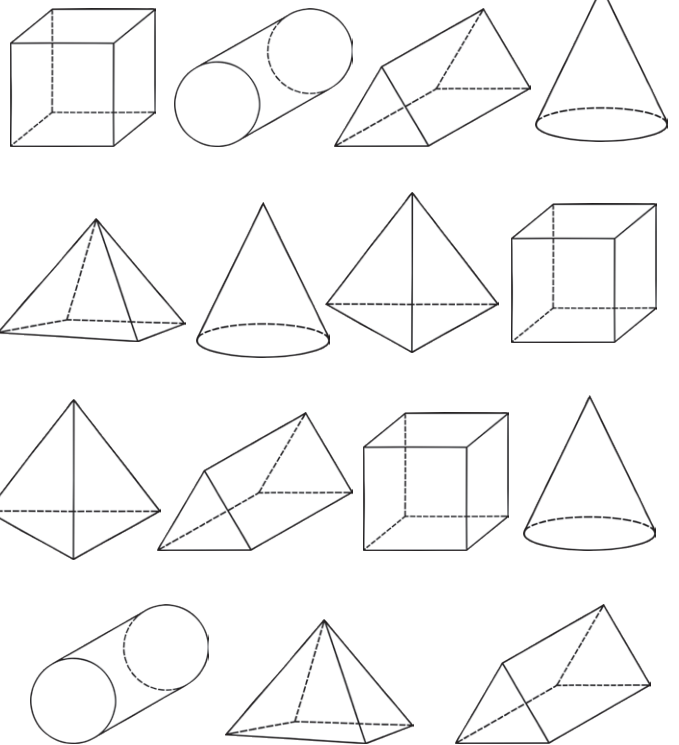

Cylinder Shape

Cylinder

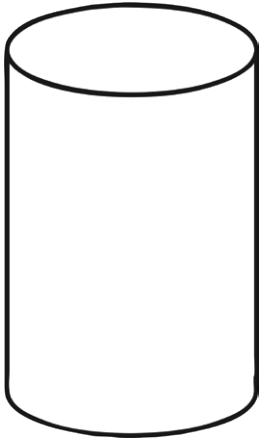

Trace

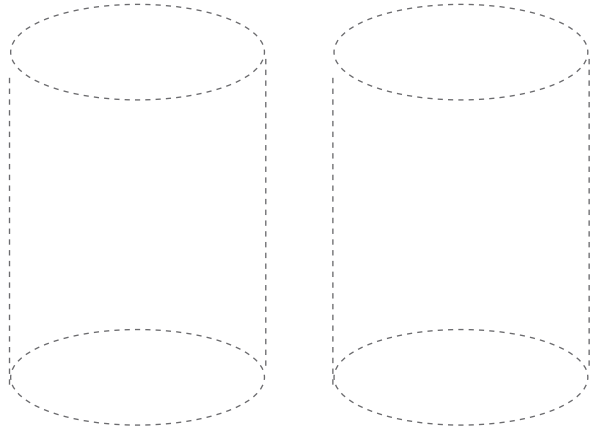

Colour in

CYLINDER

Colour in all the cylinders

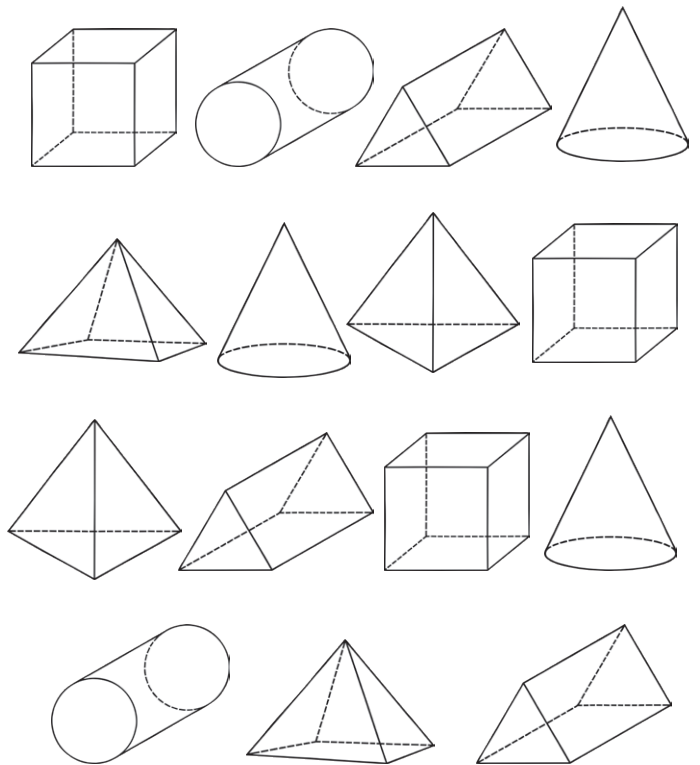

Stick the cylinders in the correct size order.



visit [twinkl.com](https://www.twinkl.com)

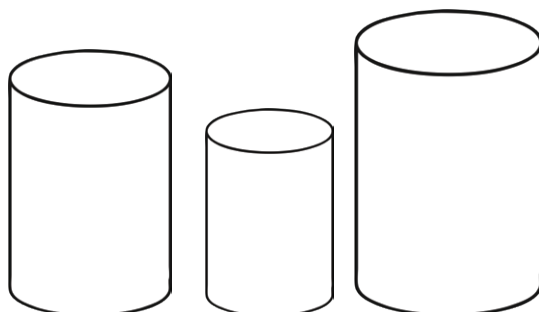

Cone Shape

Cone

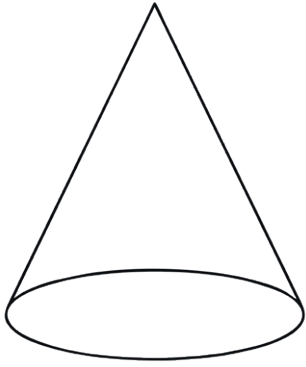

Trace

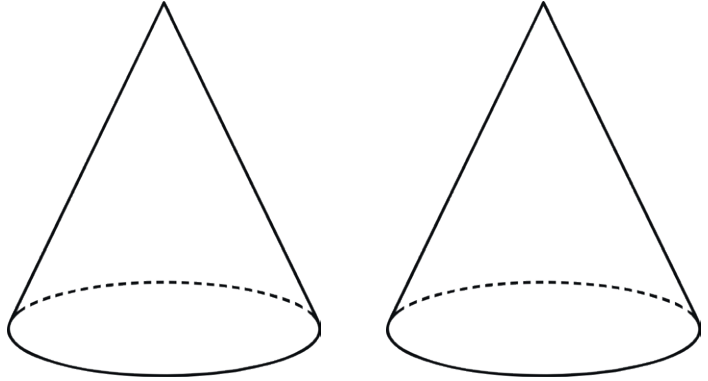

Colour in

CONE

Colour in all the cones.

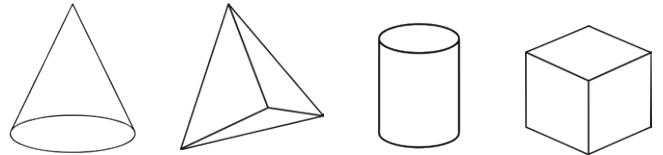
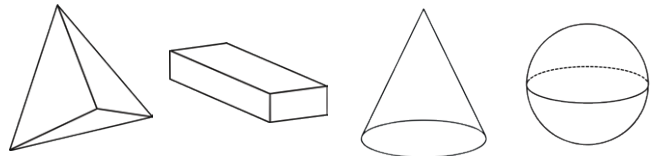
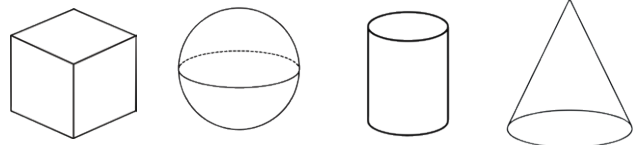
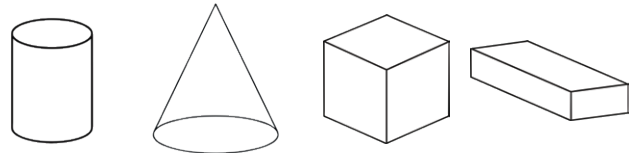

Stick the cones in the correct size order.

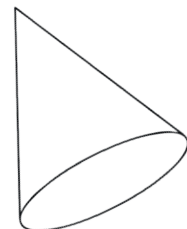
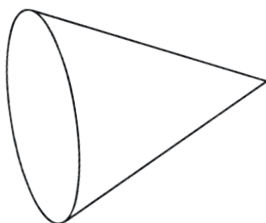

Sphere Shape

Sphere

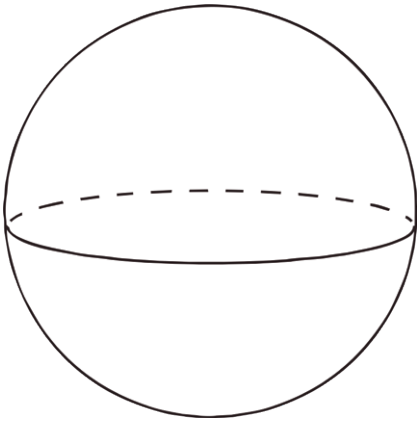

Trace

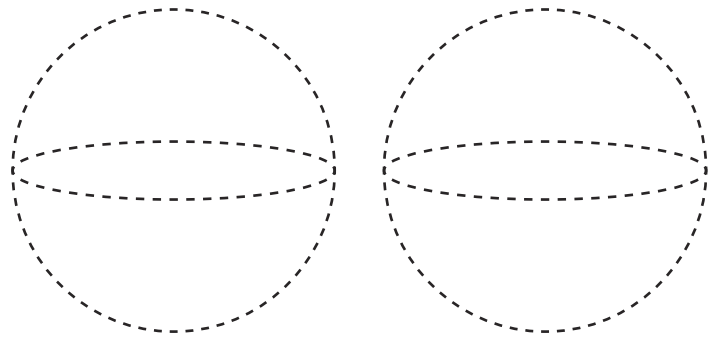

Colour in

SPHERE

Stick the spheres in the correct size order.

Colour in all the spheres.

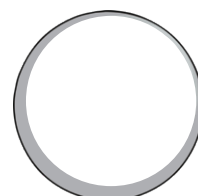
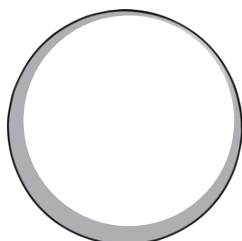
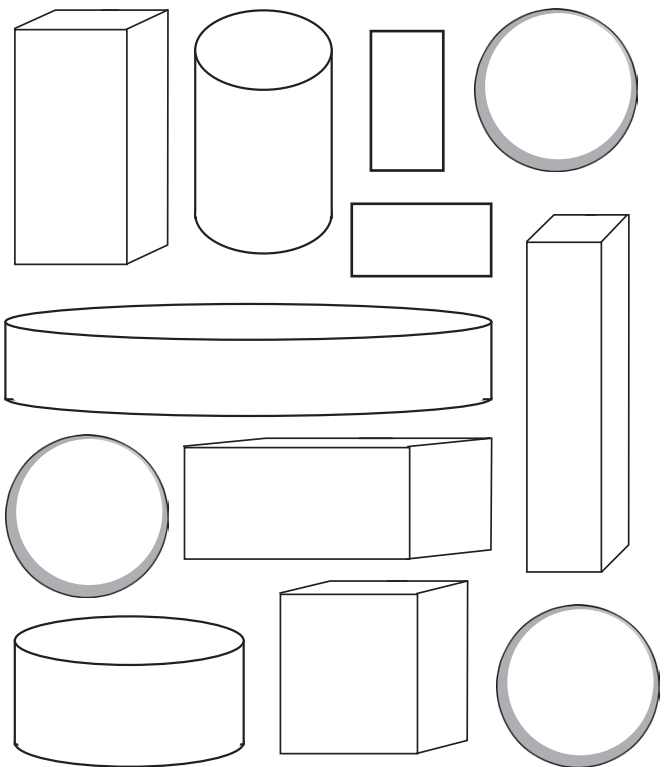

Cuboid Shape

Cuboid

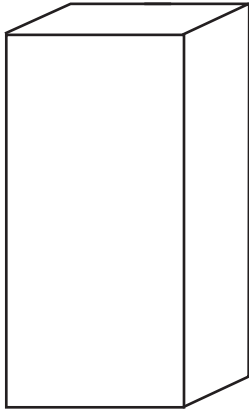

Trace

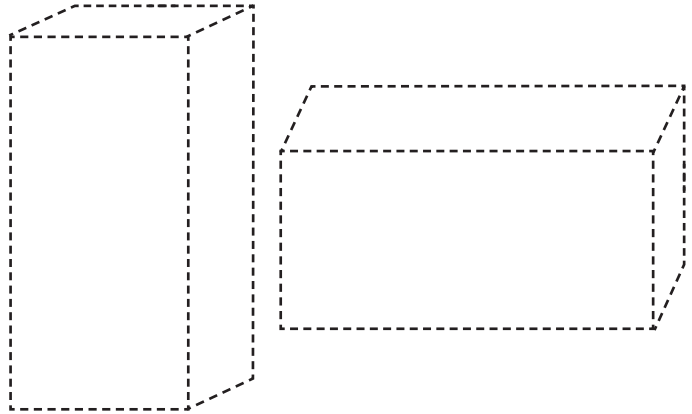

Colour in

CUBOID

Stick the cuboids in the correct size order.

Colour in all the cuboids.

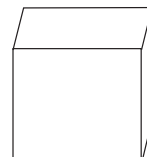
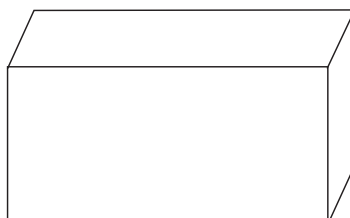
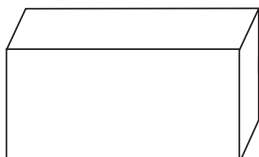
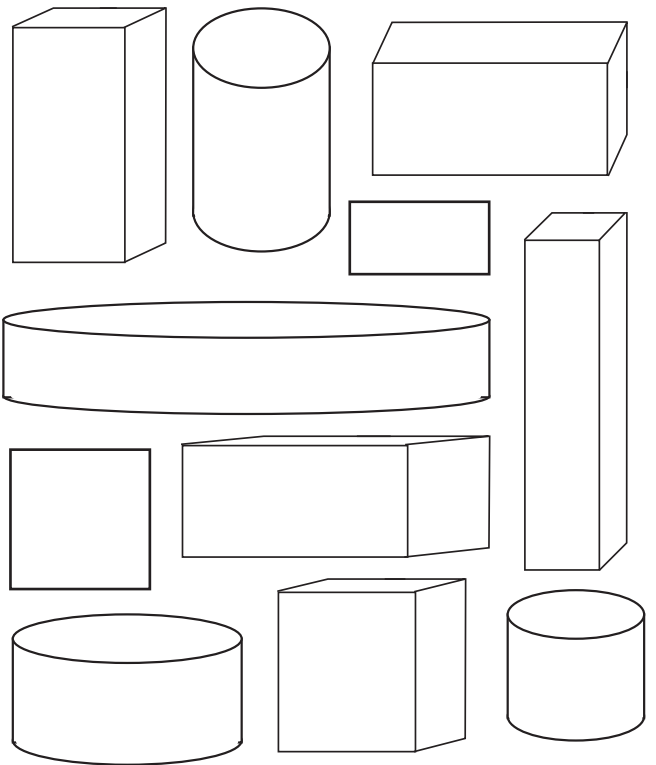

3D Shapes Colouring

Find the shapes and colour them in the correct colour.

Colour the cubes green.

Colour the spheres blue.

Colour the cones red.

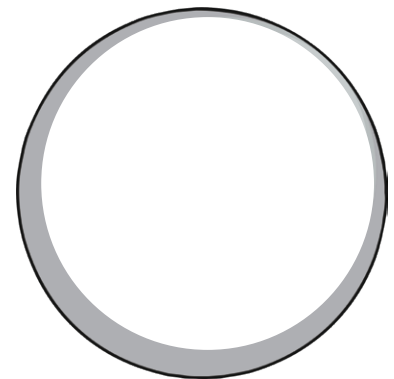
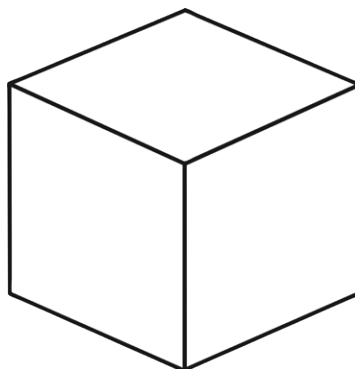
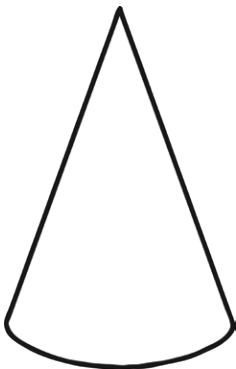
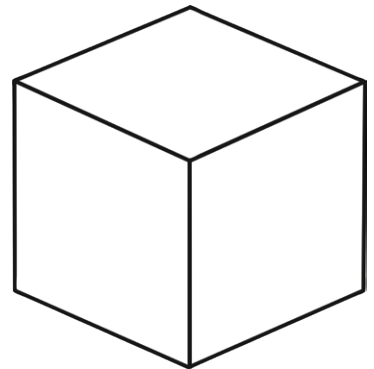
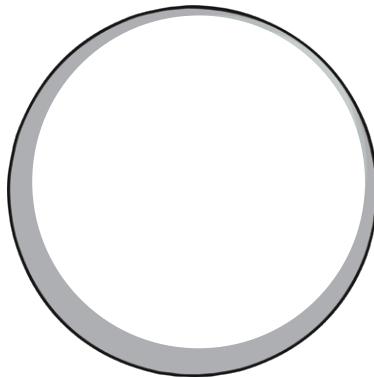
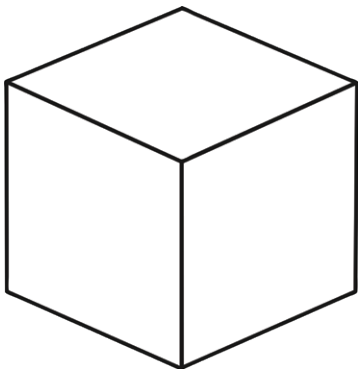
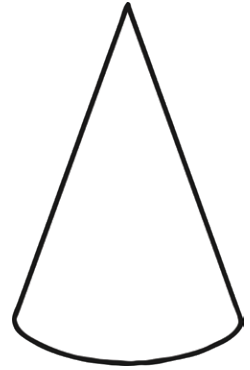
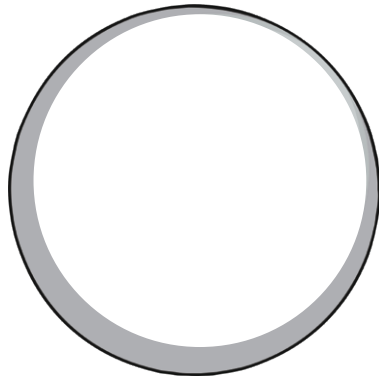
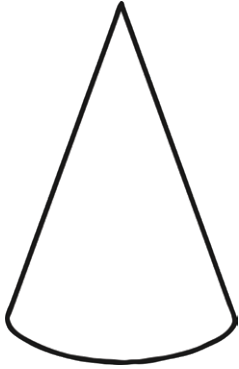

3D Shapes Colouring

Find the shapes and colour them in the correct colour.

Colour the cuboids green.

Colour the cylinders blue.

Colour the pyramids red.

