

Please make sure that you print this resource at 100% so that all measurements are correct.

To do this, follow the relevant steps below.

Adobe Reader or Adobe Acrobat

- Adobe Reader is a free PDF viewer, from Adobe. To install a copy of Adobe Reader, go to <https://get.adobe.com/uk/reader/>.
- Once Adobe Reader is installed, open your PDF.
- Go to File>Print.
- Under 'Page Sizing & Handling', select 'Size'.
- From here, make sure that 'Actual Size' is selected.
- Print this page as a test, making sure that the shape below is the correct size once printed.
- If the test print is correct, print your PDF.

Foxit Reader

- Go to File>Print.
- Set the 'Scaling' to 'None'.
- Print this page as a test, making sure that the shape below is the correct size once printed.
- If the test print is correct, print your PDF.

Web Browser

- If printing from a web browser, such as Chrome, Firefox or Microsoft Edge make sure that your printer is set to print at 100%, either by unticking 'Fit to Page' or selecting 'Actual Size'.
- Print this page as a test, making sure that the shape below is the correct size once printed.
- If the test print is correct, print your PDF.

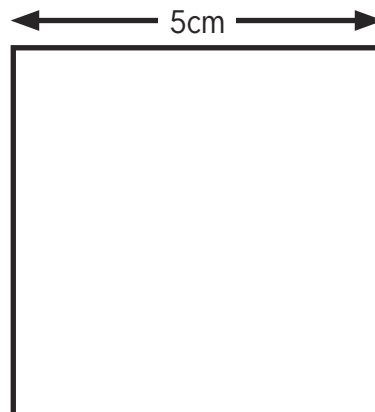

Draw Triangles (Side and 2 Angles)

Aim: I can draw triangles.

Draw the following triangles accurately, in your book, using the given side and 2 measurements.

Example:

inaccurate

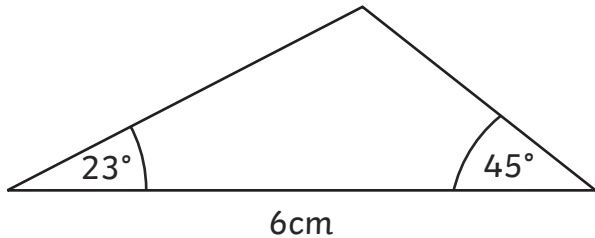

accurate

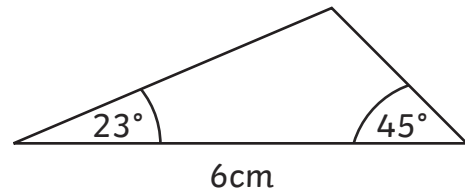

Question	Length (cm)	Angle 1	Angle 2
1	10	58°	60°
2	12	70°	30°
3	3	88°	39°
4	11	49°	51°
5	9	41°	24°
6	8	38°	87°
7	5	30°	34°
8	11	46°	84°
9	4	42°	16°
10	6	22°	18°
11	7	58°	41°
12	10	83°	43°

Draw Triangles (Side and 2 Angles) Answers

All triangles are drawn accurately.

1.

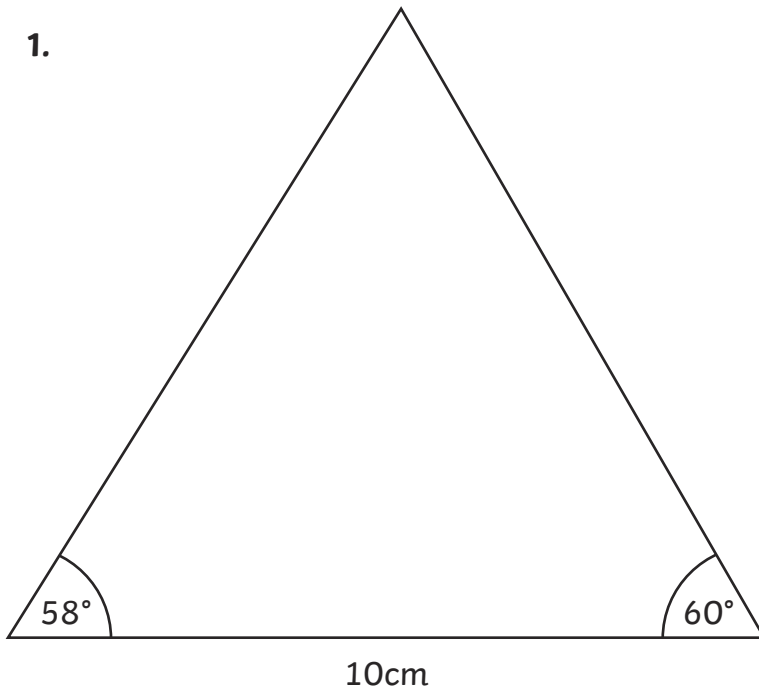

2.

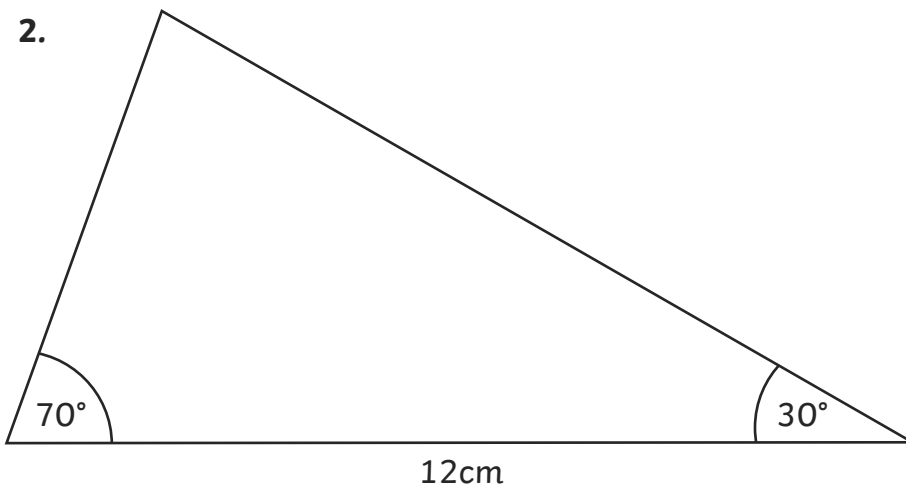

3.

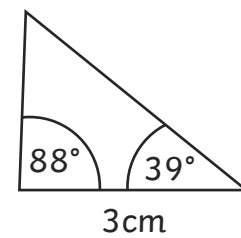

4.

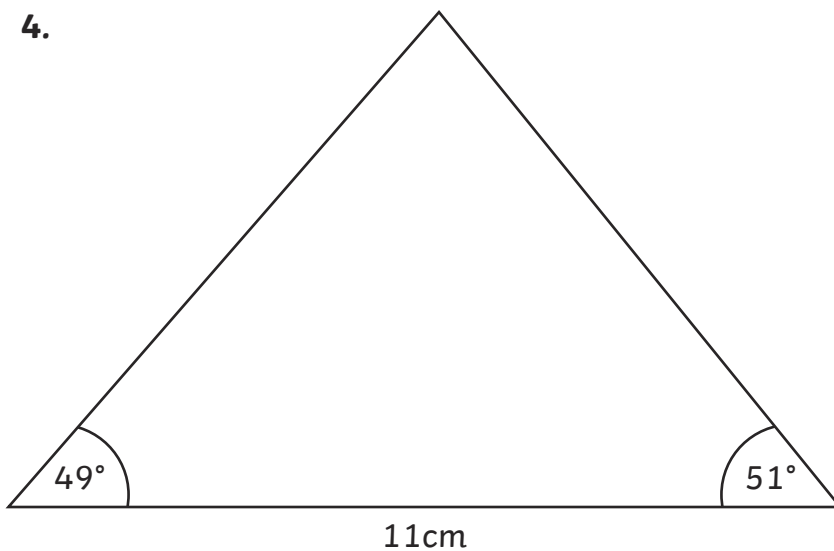

5.

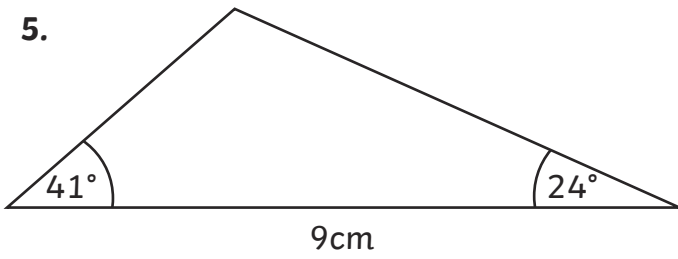

6.

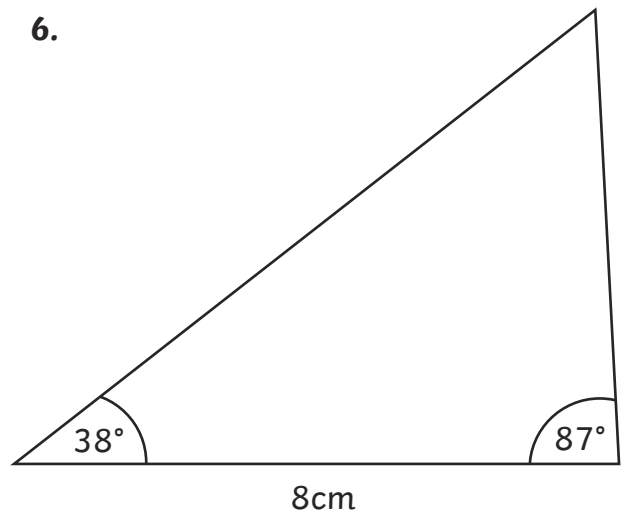

7.

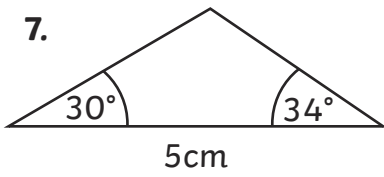

8.

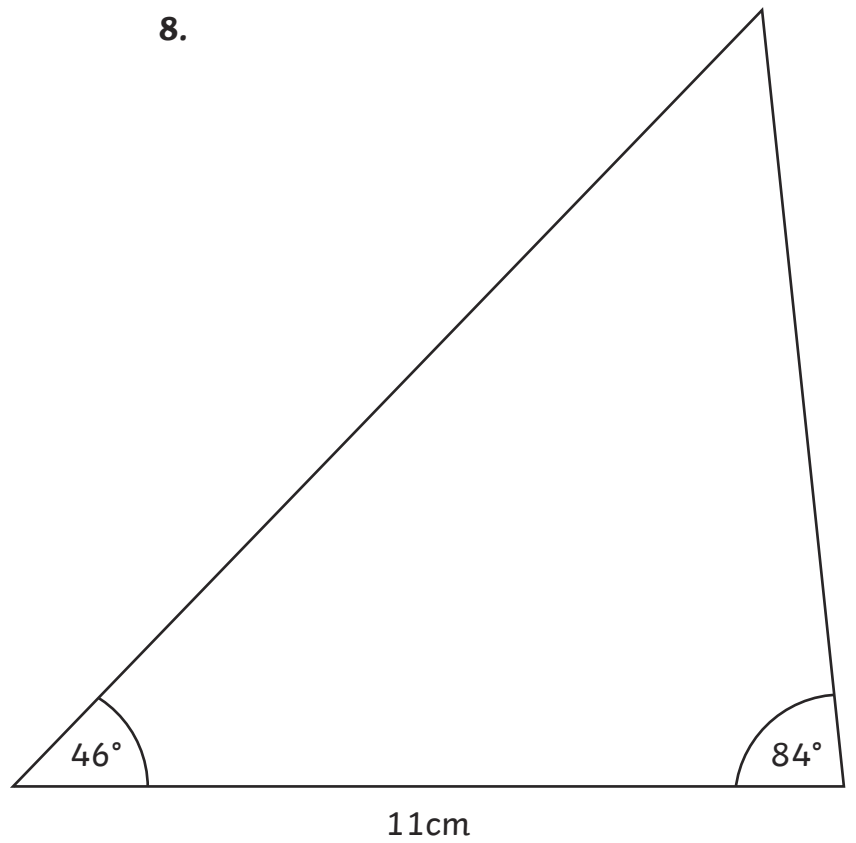

9.

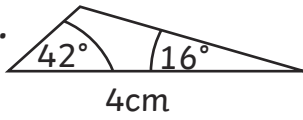

10.

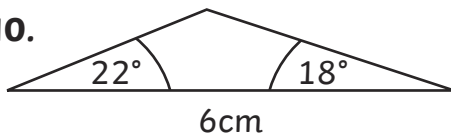

11.

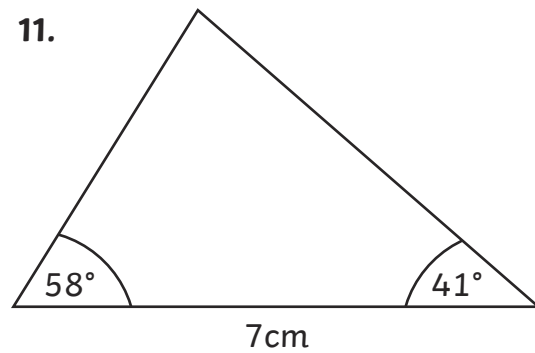

12.

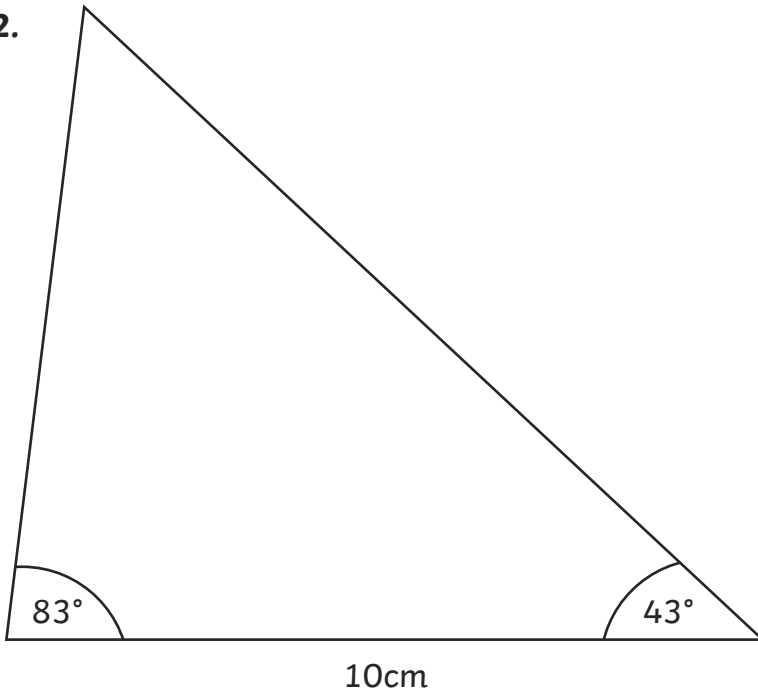

Draw Triangles (3 Sides)

Aim: I can draw triangles.

Draw the following triangles accurately, in your book, using the given 3 sides measurements.

Example:

inaccurate

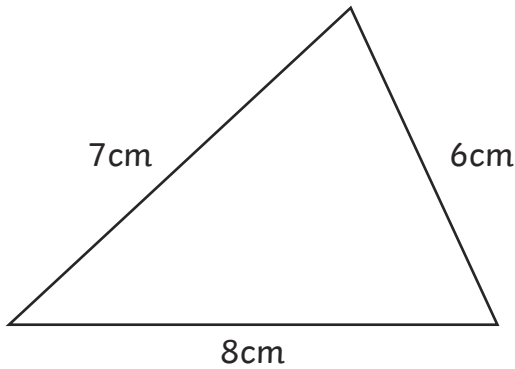

accurate

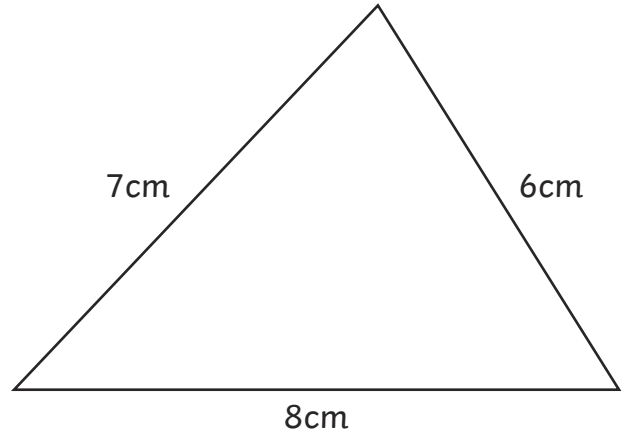

Question	Base Length (cm)	Length (cm)	Length (cm)
1	6	5	4
2	7	8	7
3	7	7	3
4	9	8	3
5	5	4	4
6	10	6	8
7	8	5	8
8	3	7	5
9	7	2	7
10	8	3	9
11	6	9	8
12	8	12	7

Draw Triangles (3 Sides) Answers

All triangles are drawn accurately.

1.

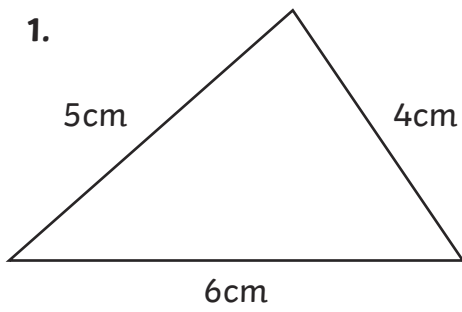

2.

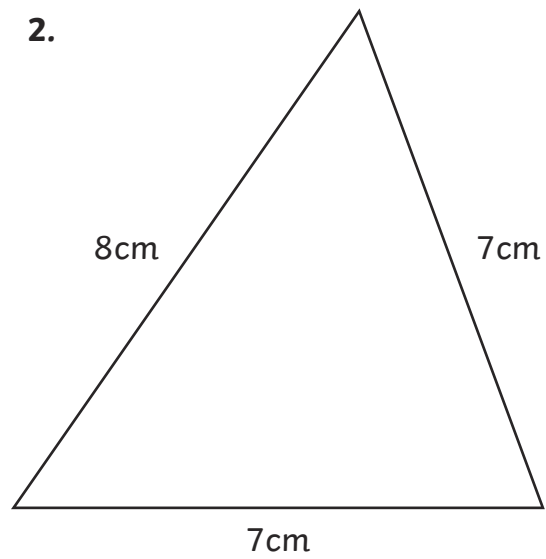

3.

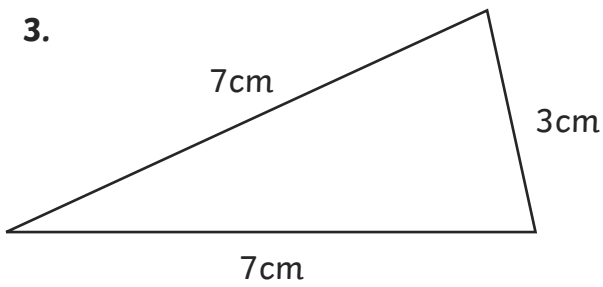

4.

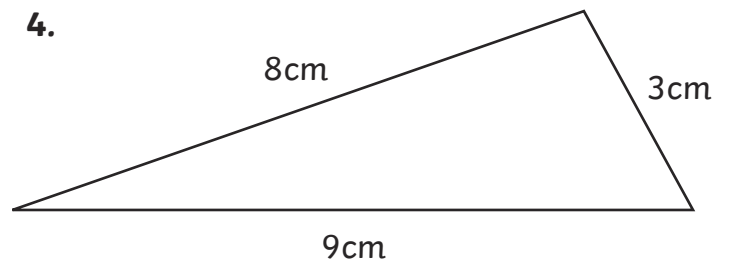

5.

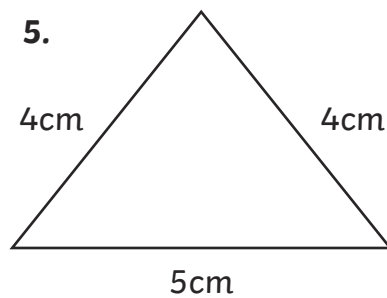

6.

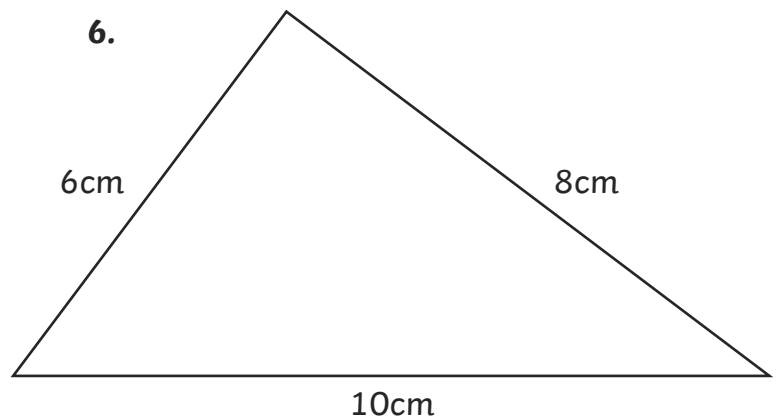

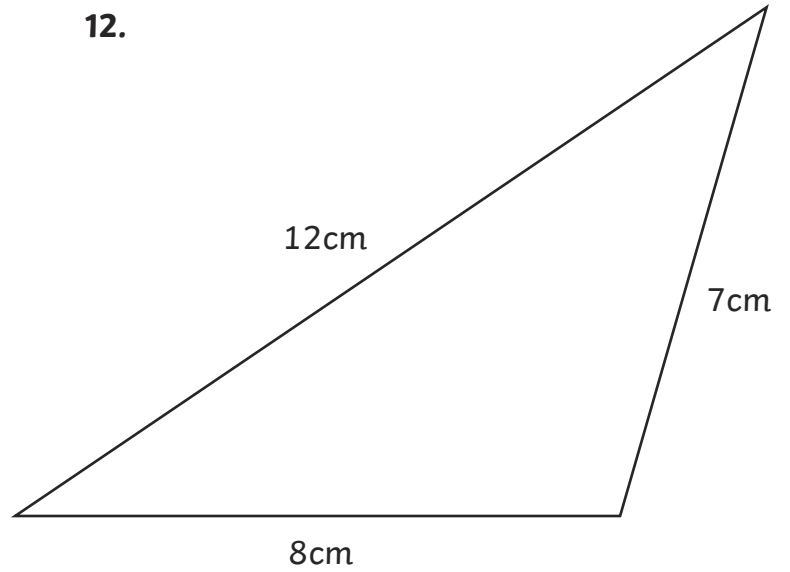
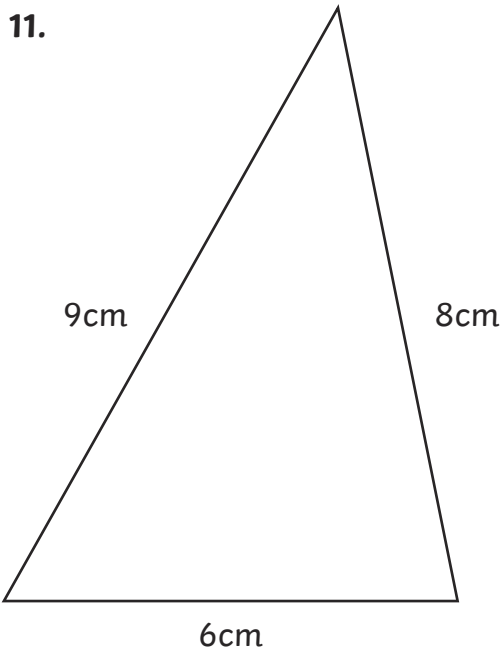
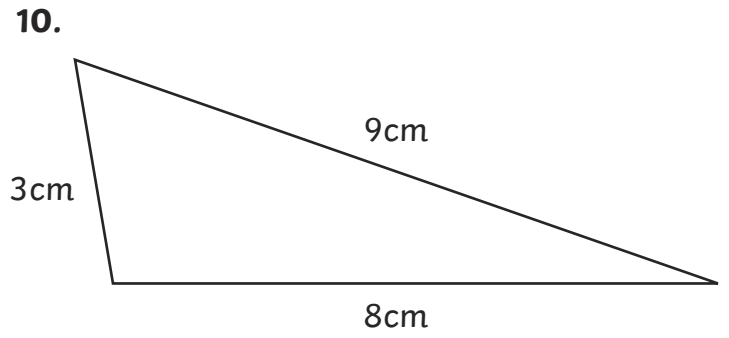
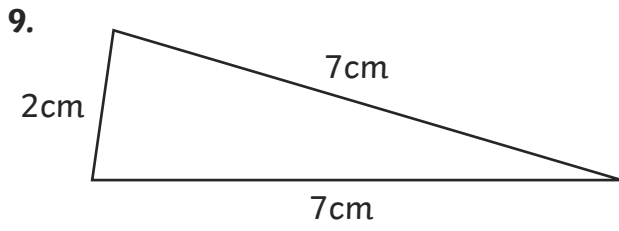
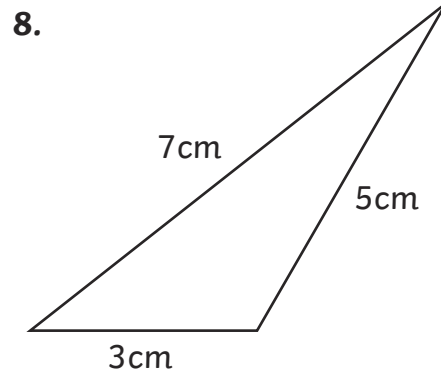
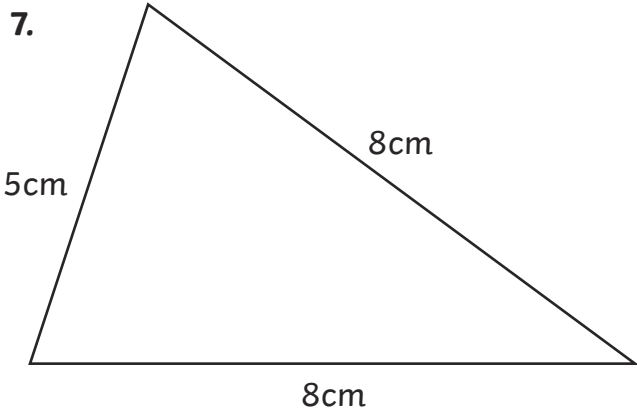

Draw Triangles (2 Sides and Angle Between)

Aim: I can draw triangles.

Draw the following triangles accurately using the given 2 sides and angle measurements.

Example:

inaccurate

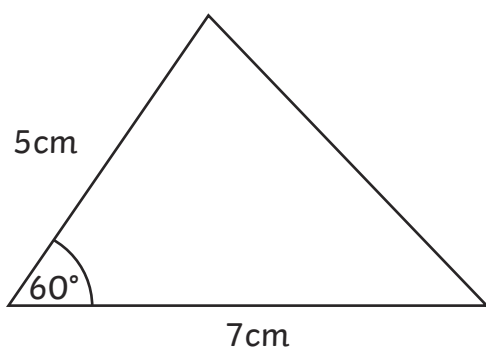

accurate

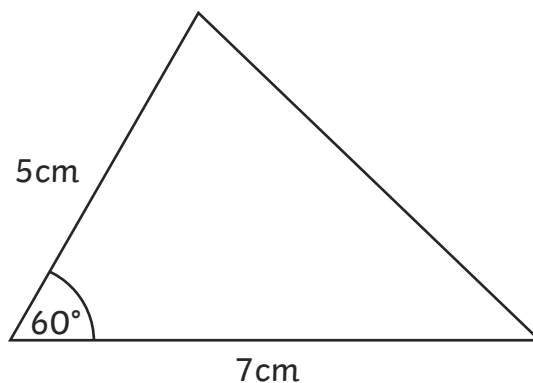

Question	Base Length (cm)	Length (cm)	Angle between
1	11	5	22°
2	5	5	20°
3	7	11	64°
4	11	10	75°
5	11	12	35°
6	7	5	38°
7	10	5	52°
8	7	5	18°
9	7	7	87°
10	11	5	69°
11	3	12	54°
12	3	9	71°

Draw Triangles (2 Sides and Angle Between) **Answers**

All triangles are drawn accurately.

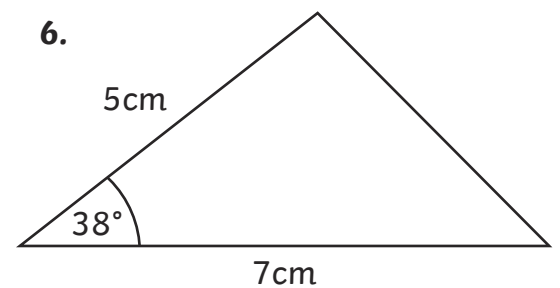
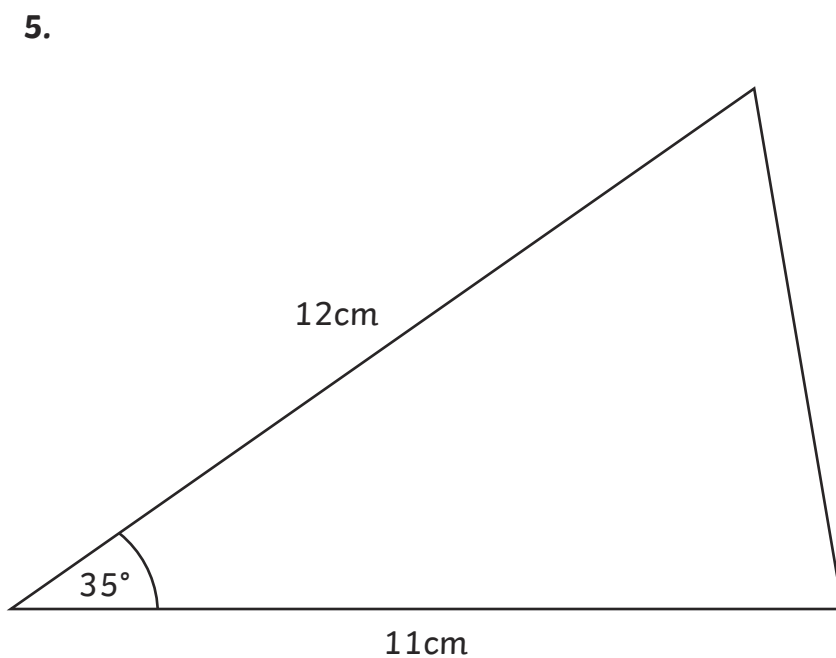
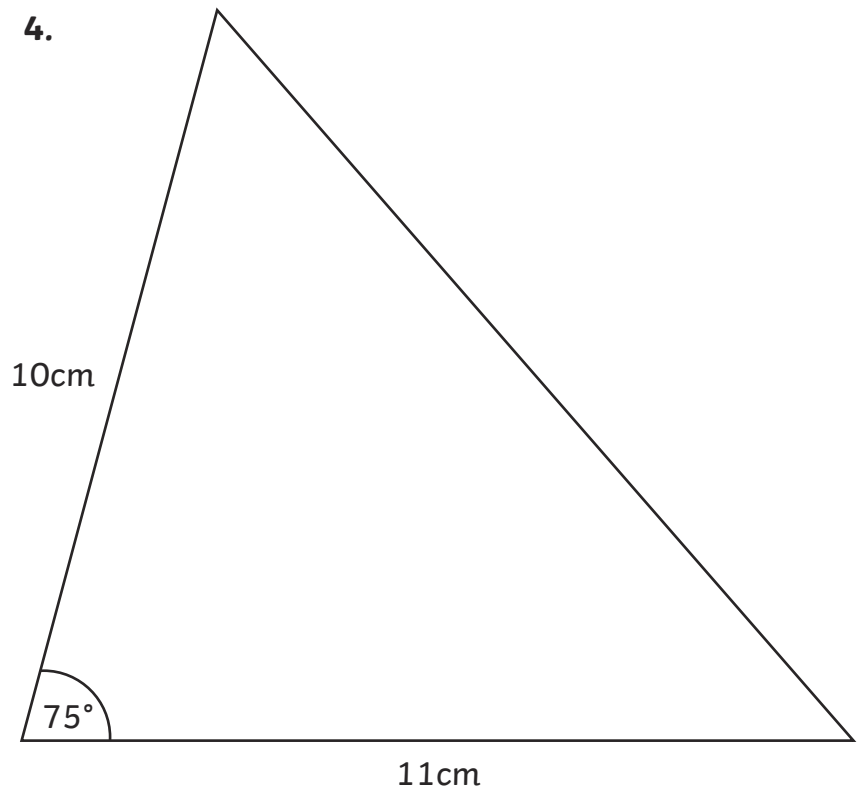
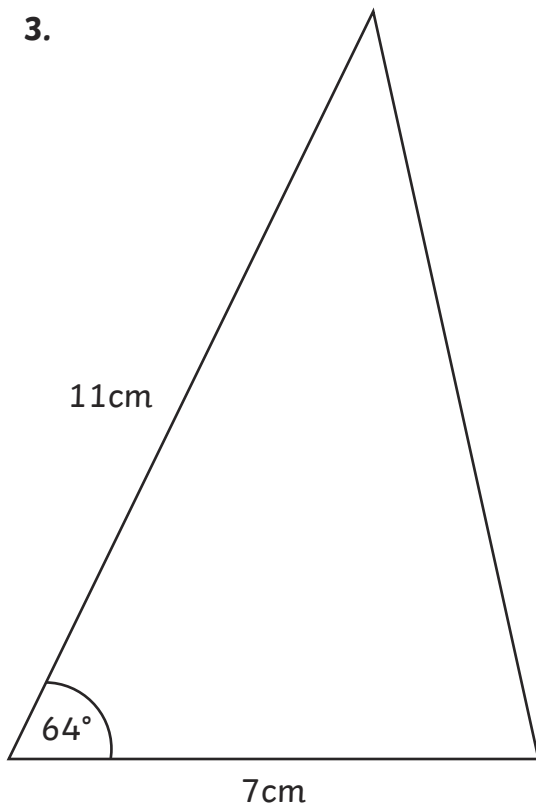
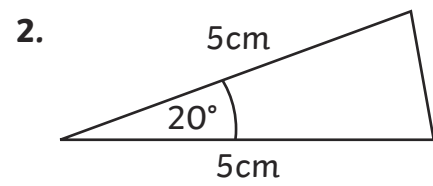
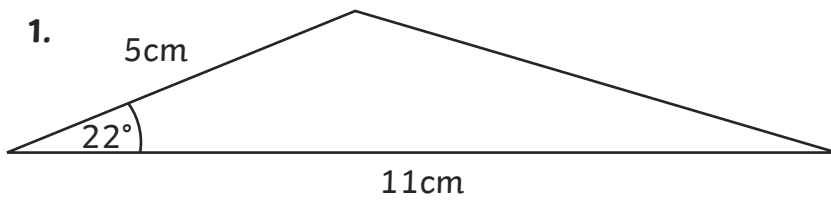

7.

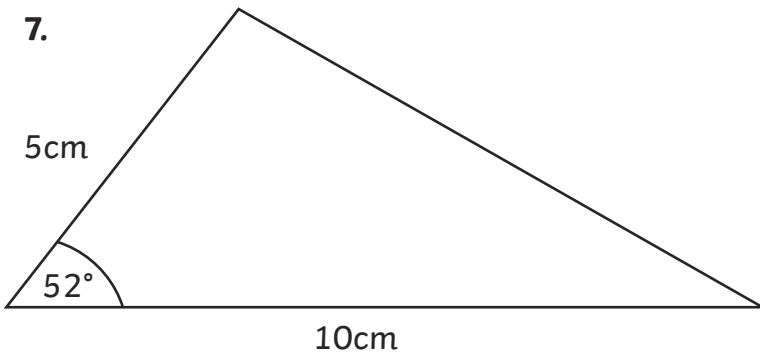

8.

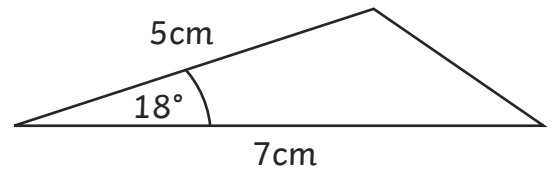

9.

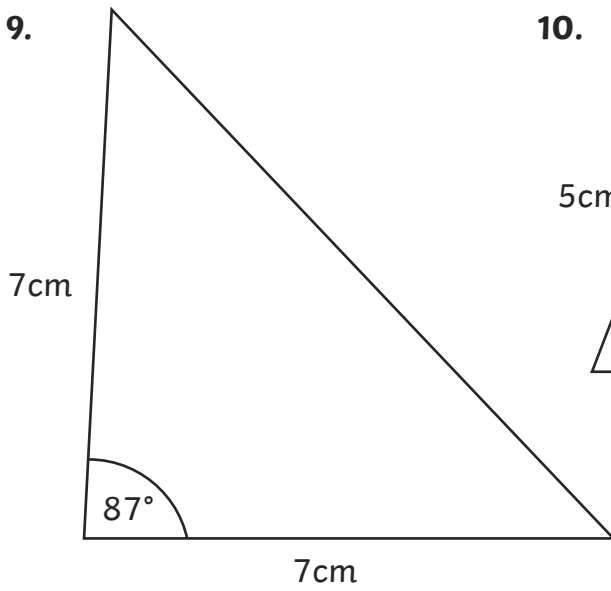

10.

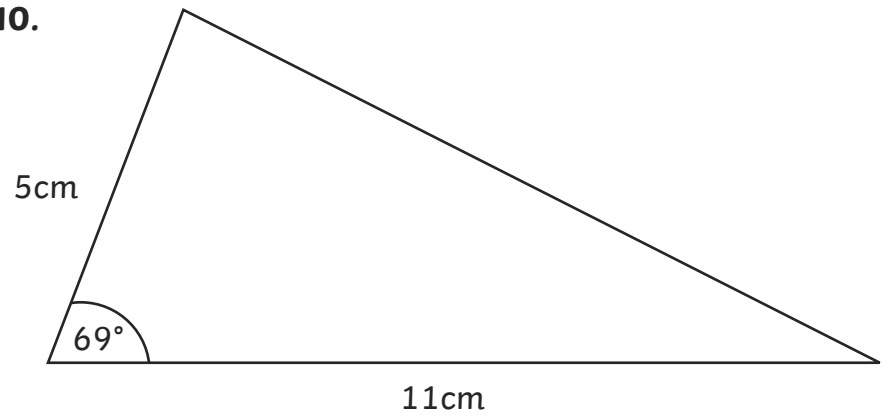

11.

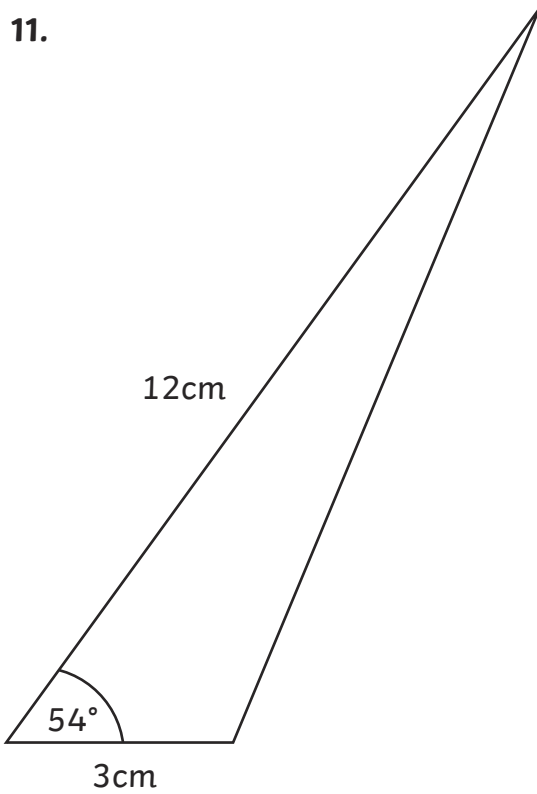

12.

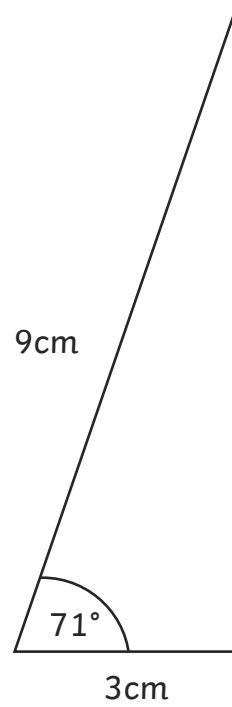

Draw Triangles (Mixed)

Aim: I can draw triangles.

Draw the following triangles accurately, in your book, using the given measurements.

Question	Base Length (cm)	Angle 1	Angle 2
1	9	46°	39°
4	8	87°	29°
7	5	37°	67°
10	10	27°	27°

Question	Base Length (cm)	Length (cm)	Length (cm)
2	7	9	12
5	10	5	8
8	8	5	9
11	10	9	4

Question	Base Length (cm)	Length (cm)	Angle between
3	10	9	40°
6	4	3	62°
9	6	10	28°
12	5	4	84°

Draw Triangles (Mixed) **Answers**

All triangles are drawn accurately.

1.

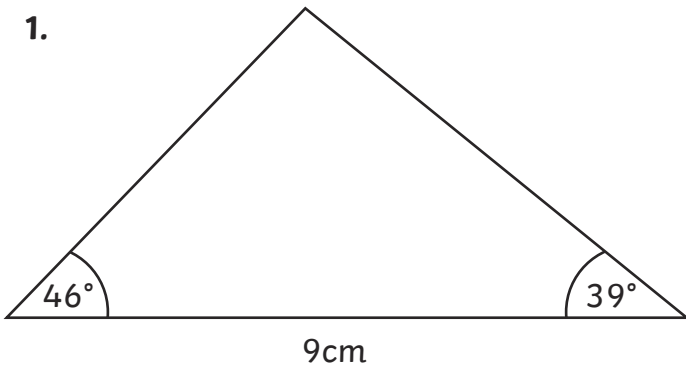

2.

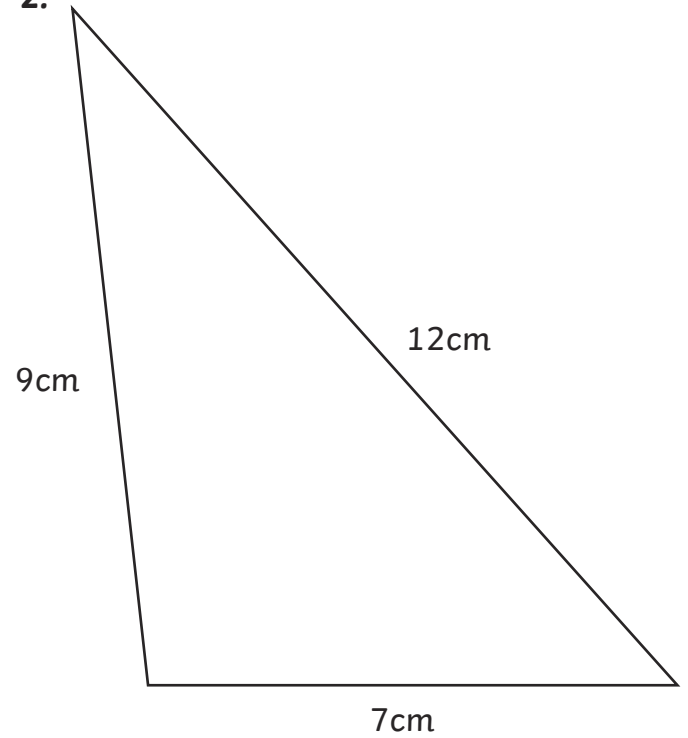

3.

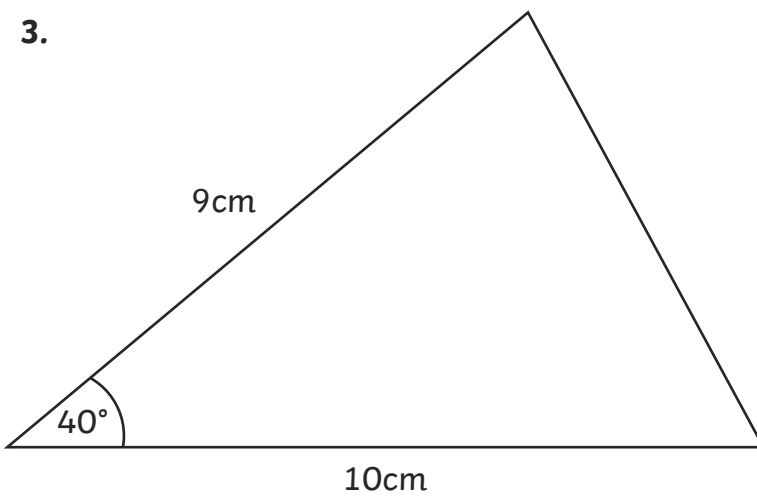

4.

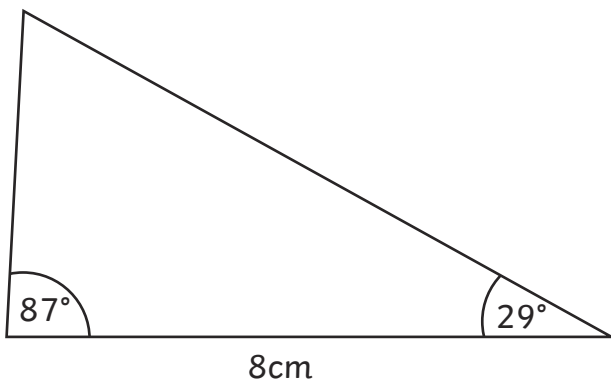

5.

