



Rounding to the Nearest Whole Number

I can round decimal numbers to the nearest whole number.



Find start on the grid below. The route to the finish square only uses decimals that round to odd whole numbers. How many different routes can you find?

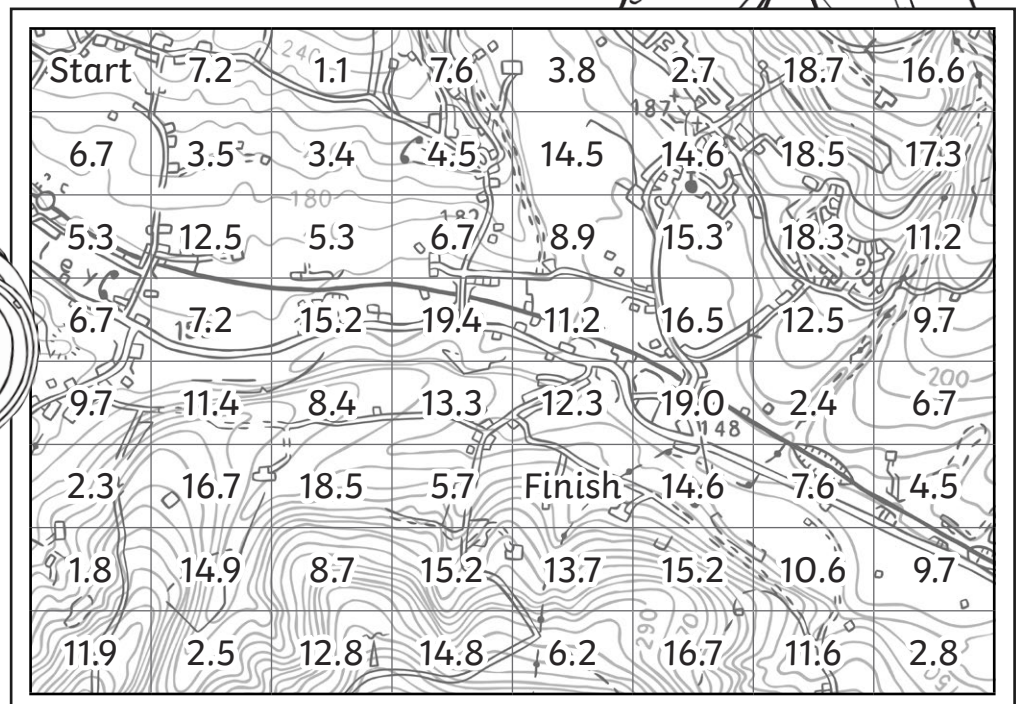
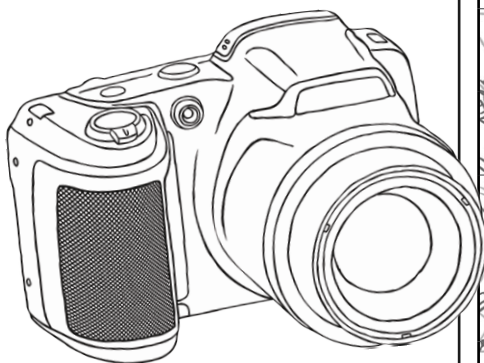
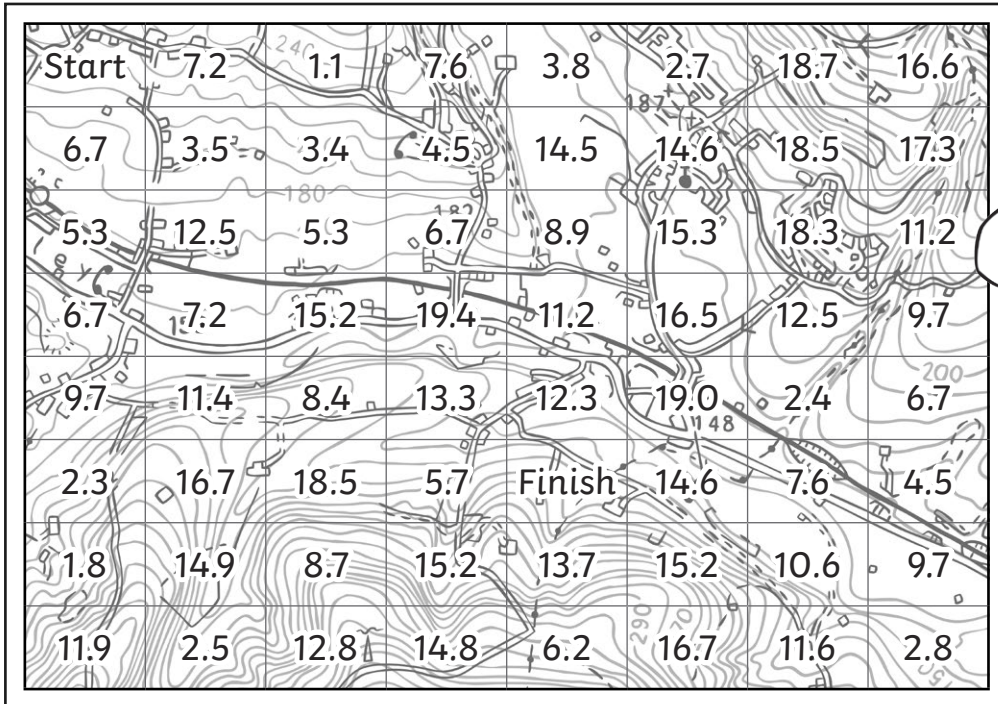

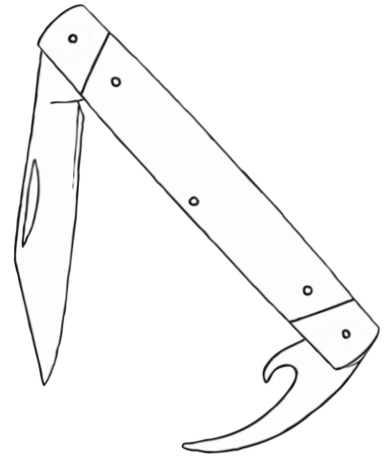
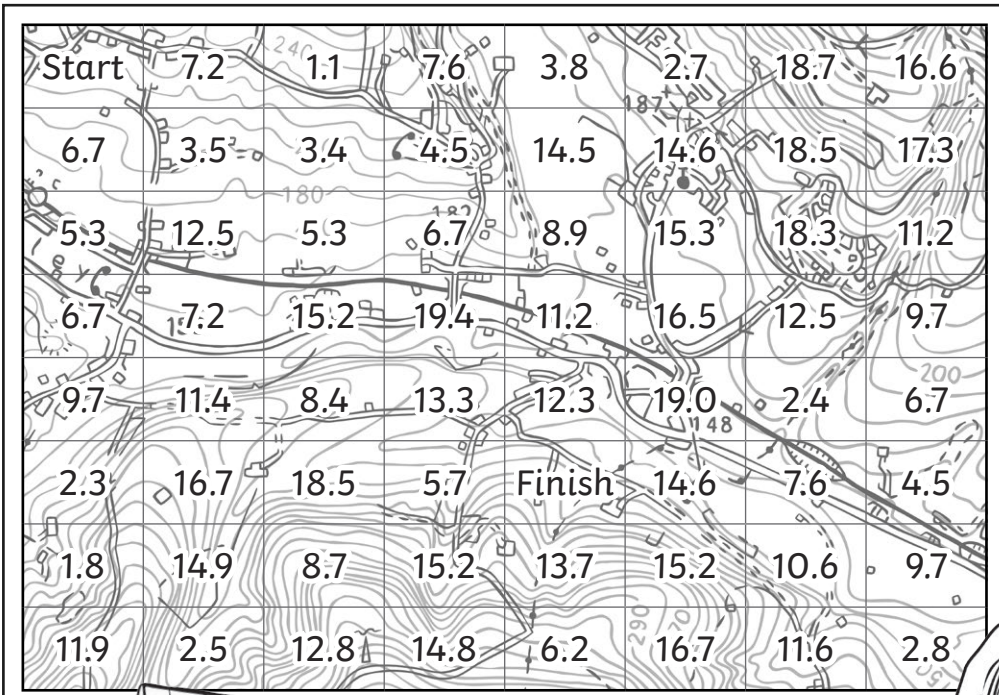
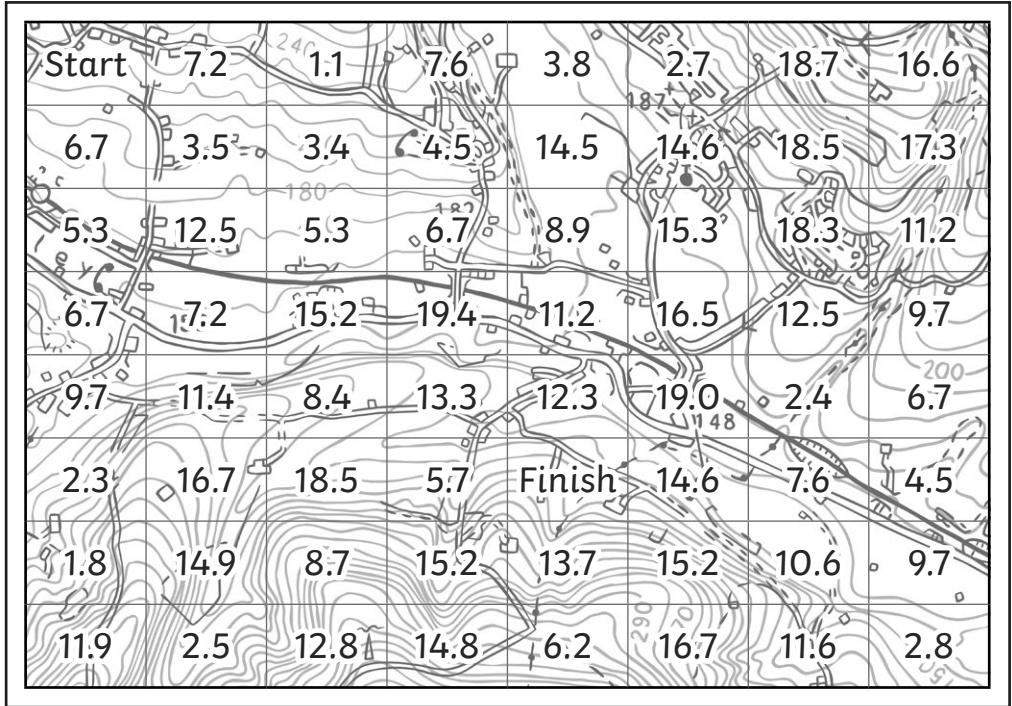
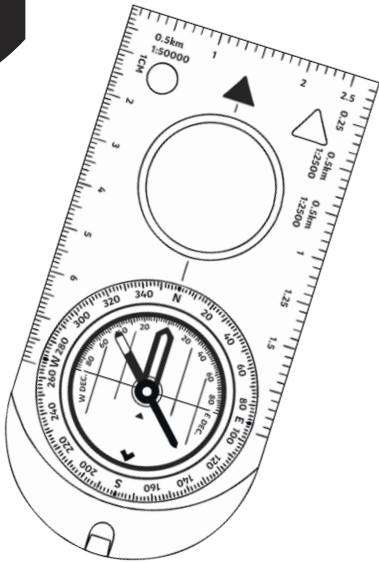



Rounding to the Nearest Whole Number

I can round decimal numbers to the nearest whole number.



Find start on the grid below. The route to the finish square only uses decimals that round to odd whole numbers. How many different routes can you find?

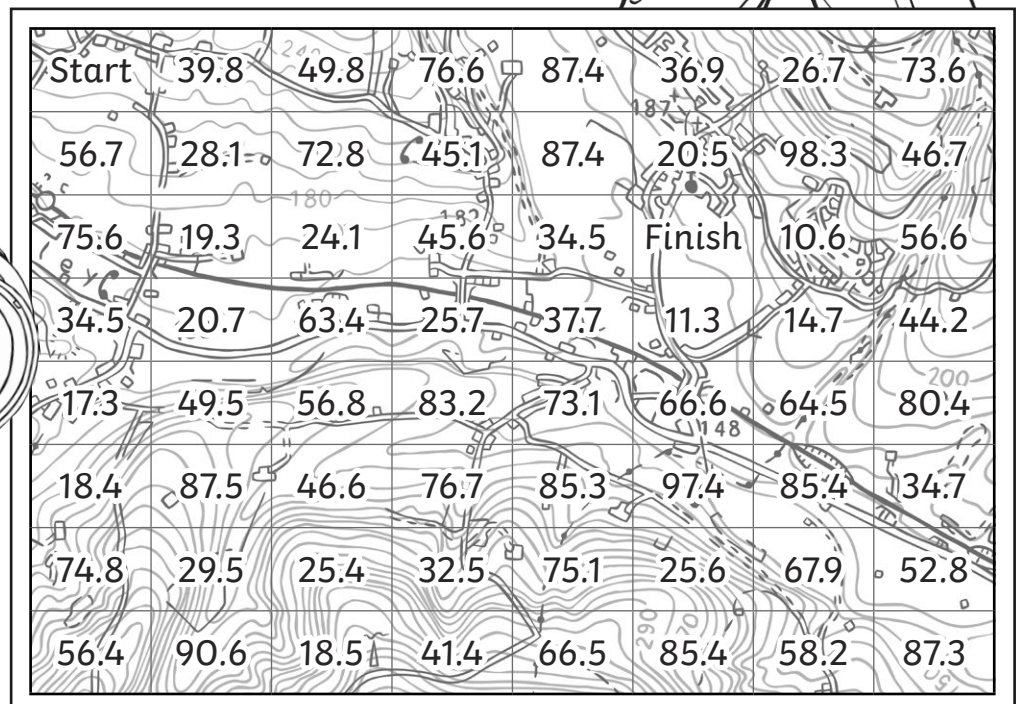
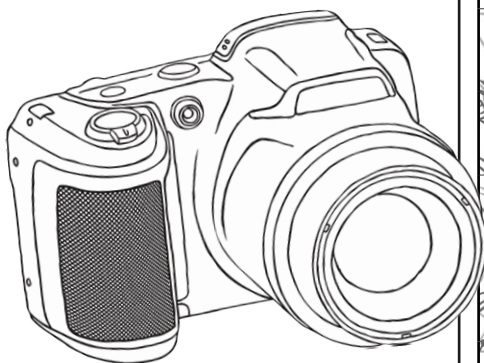
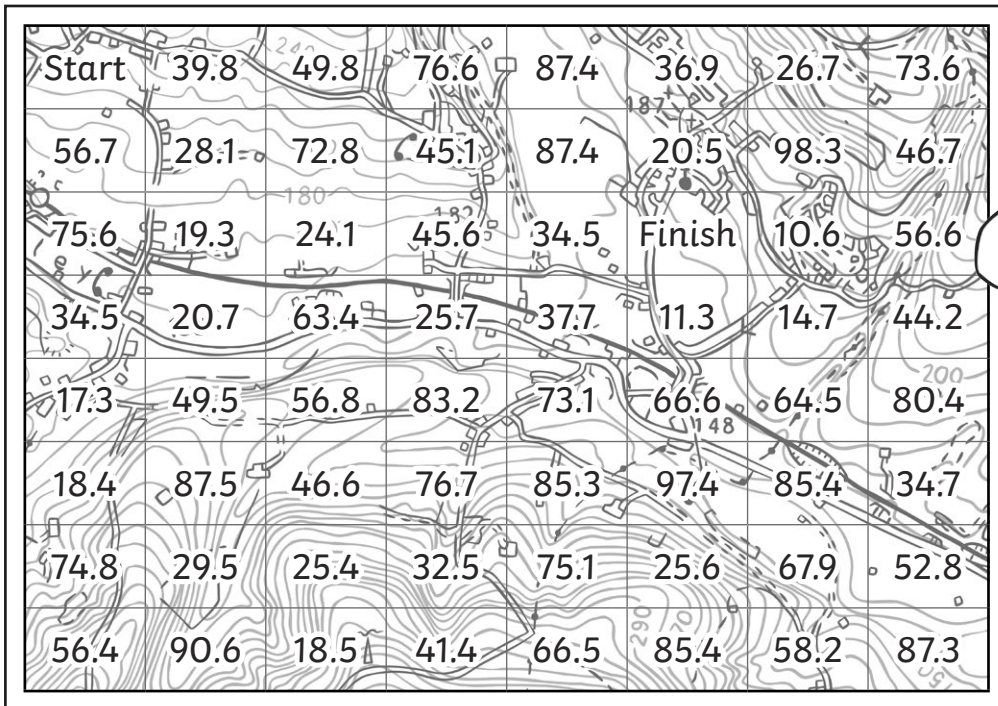

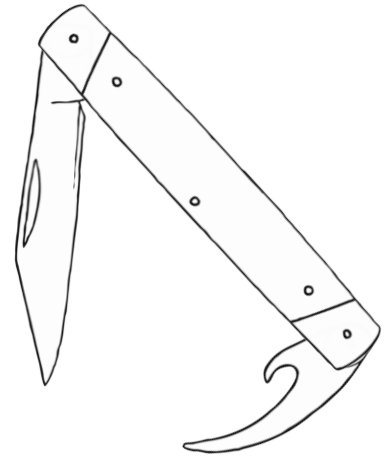
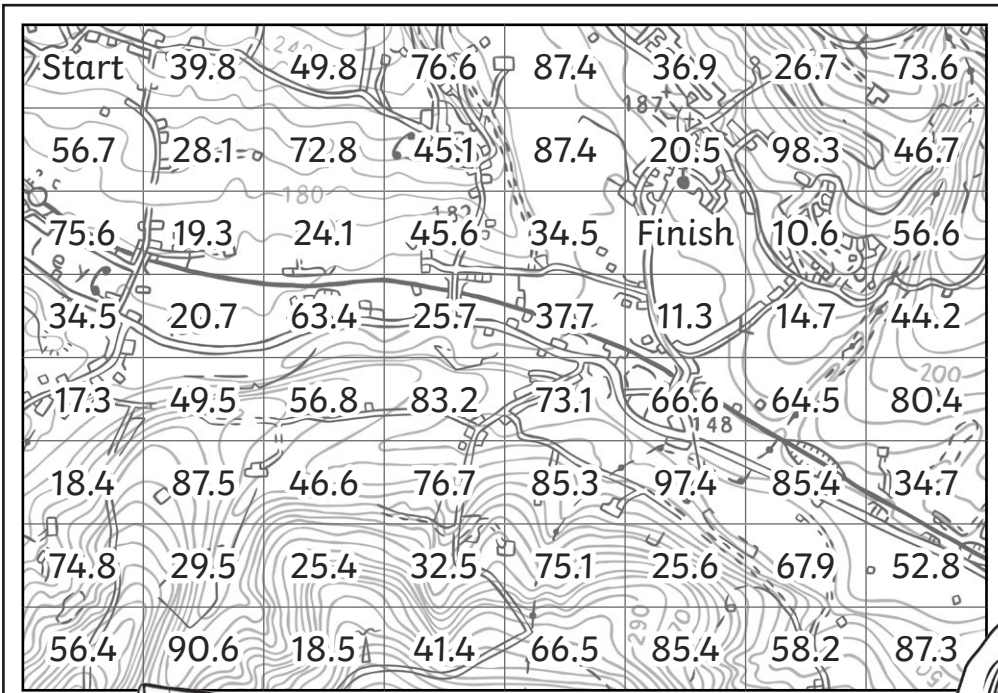
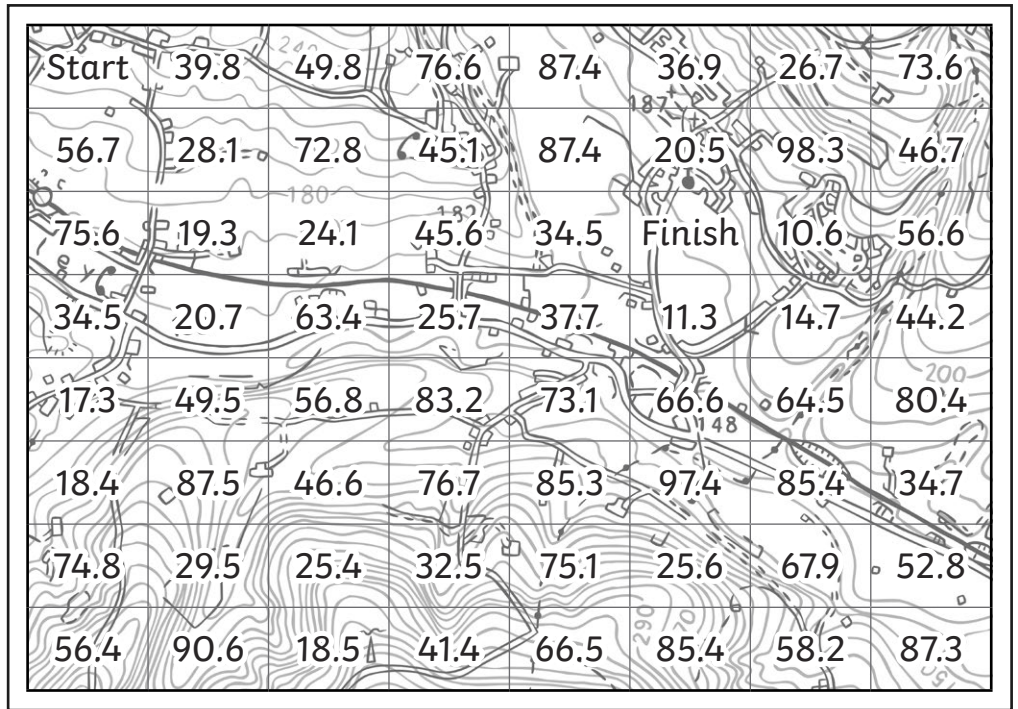
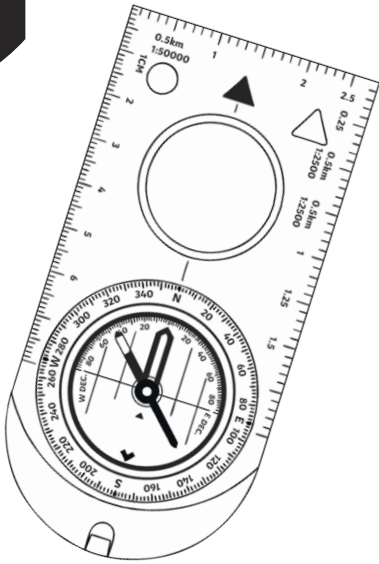



Rounding to the Nearest Whole Number

I can round decimal numbers to the nearest whole number.



Find start on the grid below. The route to the finish square only uses decimals that round to odd whole numbers. How many different routes can you find?

Start	24.65	53.56	56.8	43.21	48.87	25.7	84.5
45.6	45.2	66.5	29.4	63.4	42.6	11.14	12.56
36.7	50.6	17.44	84.7	56.2	56.7	74.69	14.53
53.5	48.84	25.64	35.4	64.91	90.7	45.32	57.4
68.3	80.5	69.7	91.3	46.7	67.3	25.6	7.62
26.4	49.2	35.1	76.9	47.26	25.6	4.7	19.4
34.42	64.55	Finish	21.27	25.64	25.2	6.5	24.7
46.74	57.7	34.4	25.7	57.86	75.4	17.99	52.6

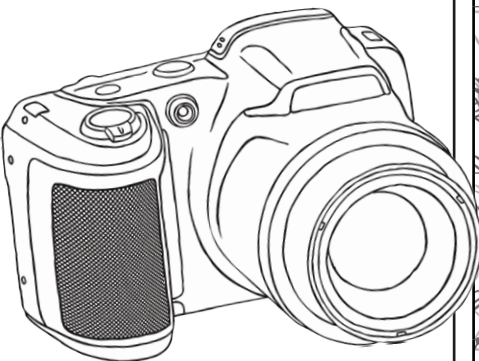

Start	24.65	53.56	56.8	43.21	48.87	25.7	84.5
45.6	45.2	66.5	29.4	63.4	42.6	11.14	12.56
36.7	50.6	17.44	84.7	56.2	56.7	74.69	14.53
53.5	48.84	25.64	35.4	64.91	90.7	45.32	57.4
68.3	80.5	69.7	91.3	46.7	67.3	25.6	7.62
26.4	49.2	35.1	76.9	47.26	25.6	4.7	19.4
34.42	64.55	Finish	21.27	25.64	25.2	6.5	24.7
46.74	57.7	34.4	25.7	57.86	75.4	17.99	52.6

