

# Year 5 Maths Number and Place Value Workbook

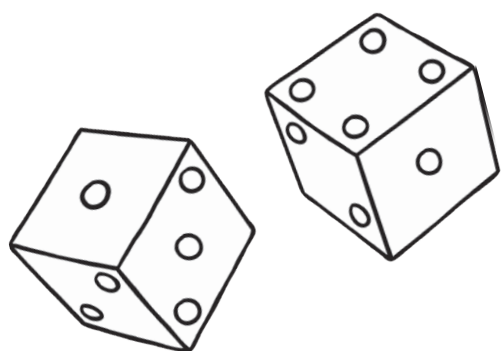

123

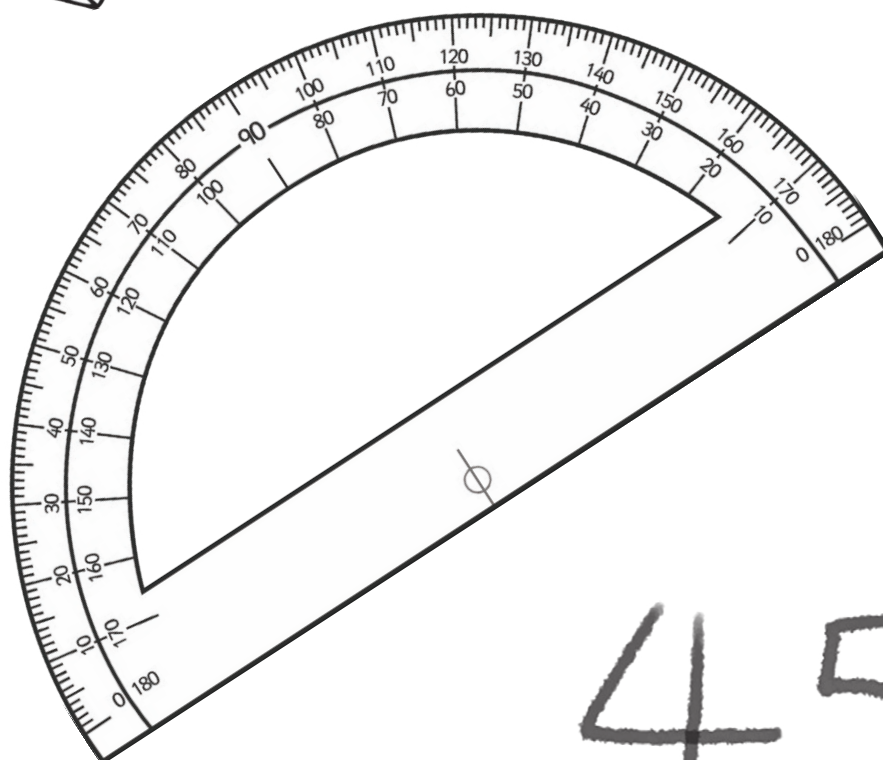

45

# Home Learning Year 5 Maths Workbook Pack

Year 5 Programme of Study - Number and Place Value

Statutory Requirements	Worksheet	Page Number	Notes
Read, write, order and compare numbers to at least 1 000 000 and determine the value of each digit.	<ul style="list-style-type: none"> <li>• Number Partitioning Worksheet</li> <li>• Ordering Numbers Worksheet</li> <li>• Writing Numbers in words</li> </ul>	<p>3</p> <p>4 - 6</p> <p>7 - 9</p>	
Count forwards or backwards in steps of powers of 10 for any given number up to 1 000 000.	<ul style="list-style-type: none"> <li>• Counting in Multiples of 10 from any number</li> <li>• Counting forwards or backwards in Powers of Ten</li> <li>• Counting Back in Powers of Ten Worksheets</li> </ul>	<p>10</p> <p>11</p> <p>12 - 14</p>	
Interpret negative numbers in context, count forwards and backwards with positive and negative whole numbers, including through 0.	<ul style="list-style-type: none"> <li>• Counting Forwards and Backwards with Positive and Negative Whole Numbers</li> </ul>	15 - 16	
Round any number up to 1 000 000 to the nearest 10, 100, 1000, 10 000 and 100 000.	<ul style="list-style-type: none"> <li>• Match the thousand to the number rounding worksheet</li> <li>• Rounding 10 000's worksheet</li> <li>• Rounding 100 000's worksheet</li> </ul>	<p>17</p> <p>18 - 19</p> <p>20 - 21</p>	

# Home Learning Year 5 Maths Workbook Pack

Year 5 Programme of Study - Number and Place Value

Statutory Requirements	Worksheet	Page Number	Notes
Solve number problems and practical problems that involve all of the above.	• Counting Forwards and Backwards in Powers of 10	22	
	• Word Problems Worksheet	23	
	• Word Problems involving Negative Numbers	24 - 25	
Read Roman numerals to 1000 (M) and recognise years written in Roman numerals.	• Roman Numerals Worksheet	26	
	• Roman Numerals - Recognising Years	27 - 28	

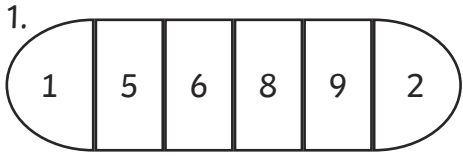
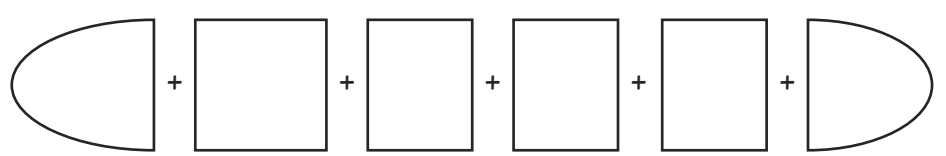

# Number Partitioning

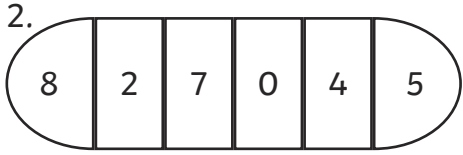
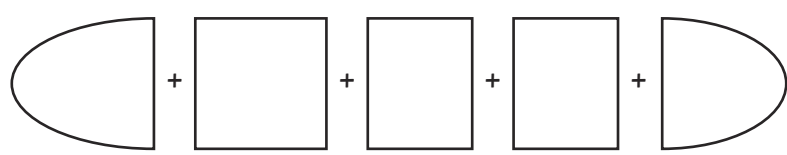
1.  = 

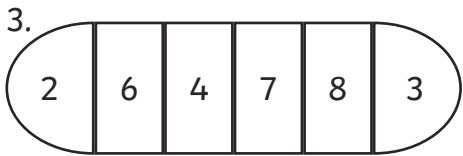
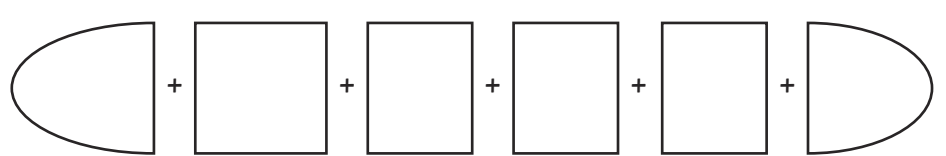

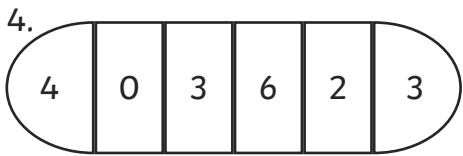
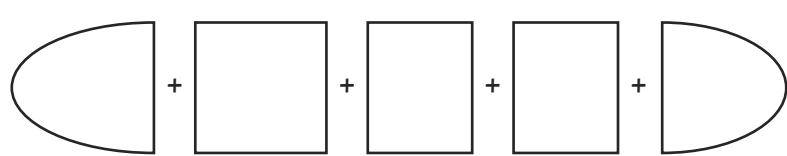
2.  = 

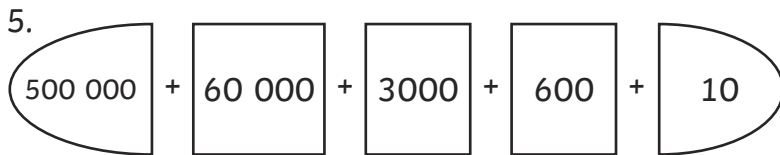

3.  = 

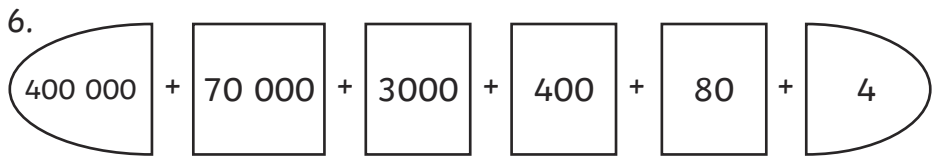
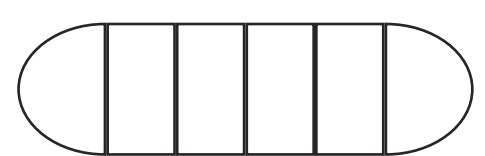
4.  = 

5.  = 

6.  = 

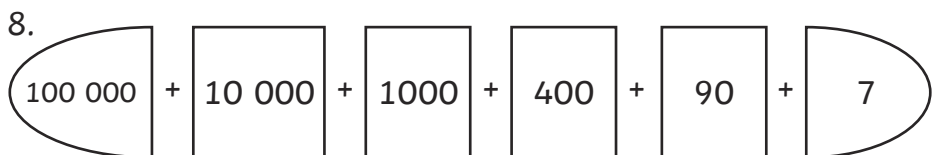
7.  = 

8.  = 

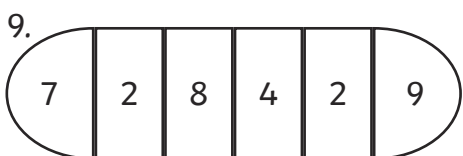
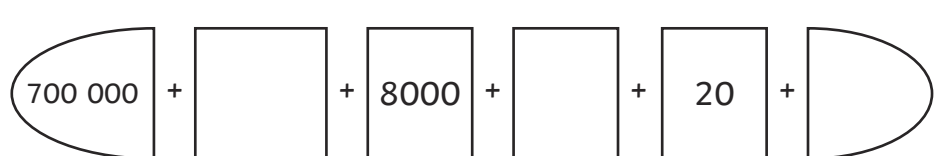
9.  = 

# Ordering Numbers to 10 000

Fill in the spaces below with the numbers in order from smallest to largest.

2212

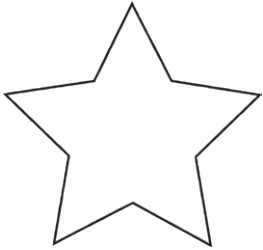

2012

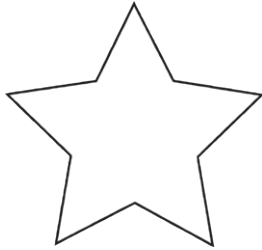

1201



1022



2120



7676

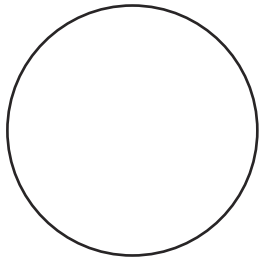

6776

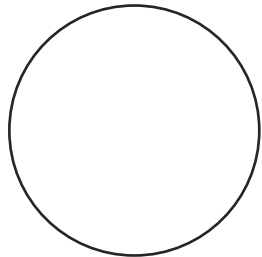

6677

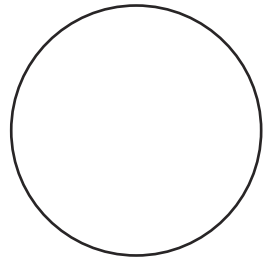

7767

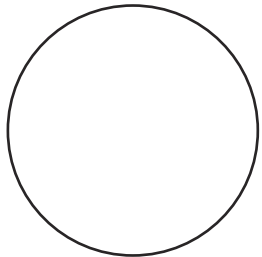

7776

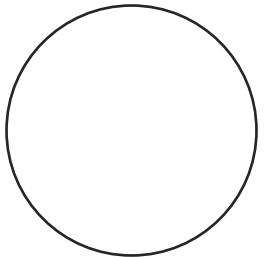

4849

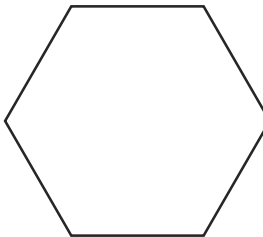

4948

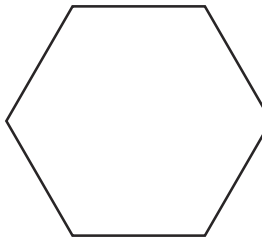

4489

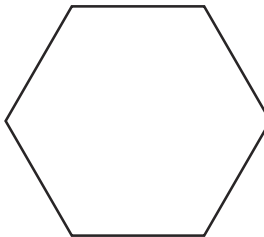

4994

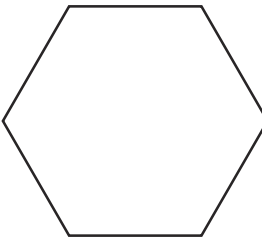

449

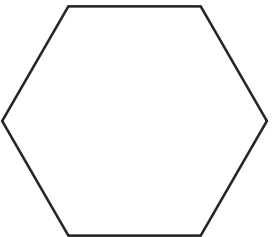

1161



6161



1616



6611



6616



7220

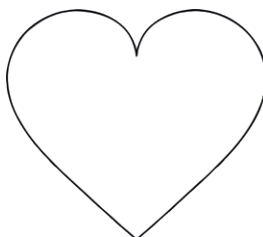

2770

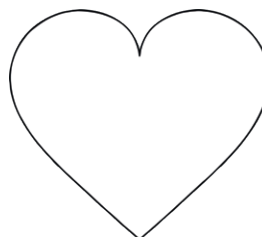

770



720

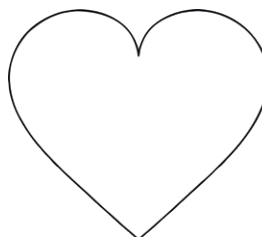

2707

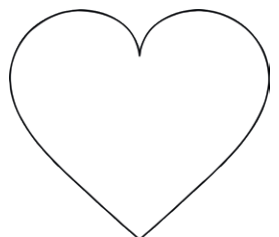

# Ordering Numbers to 100 000

Fill in the spaces below with the numbers in order from smallest to largest.

35 435



34 534



35 533

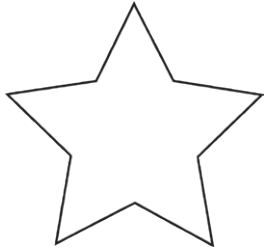

34 453



34 543



89 998

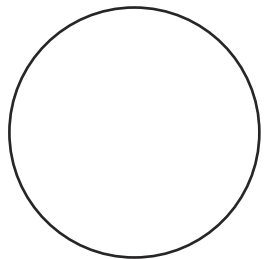

89 989

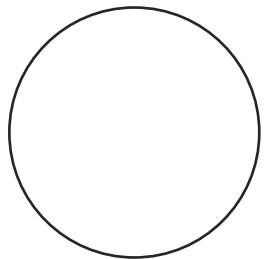

88 988

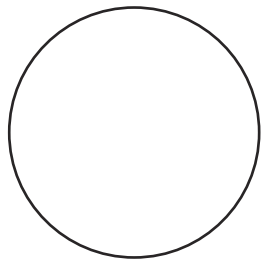

88 899

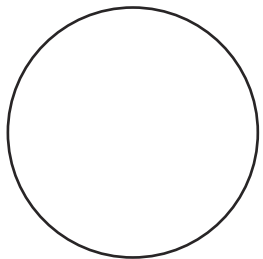

89 899

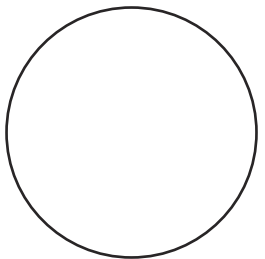

17 717

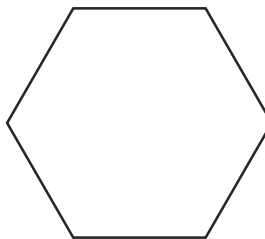

7771

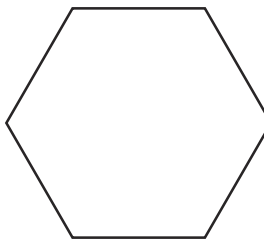

7177

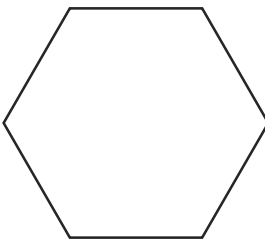

77 717

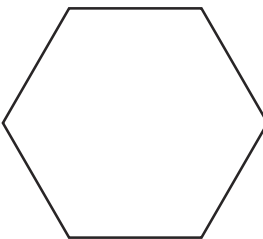

71 717

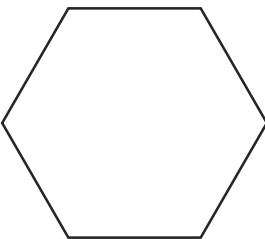

25 645



26 255



25 562



24 654



25 622



4091

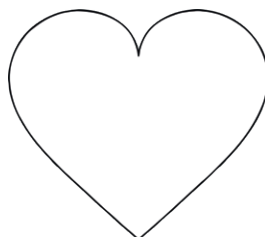

491

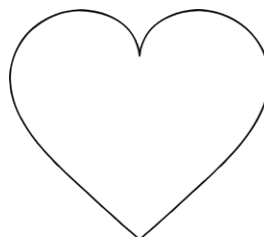

4901

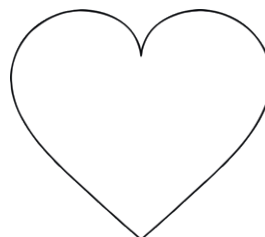

914

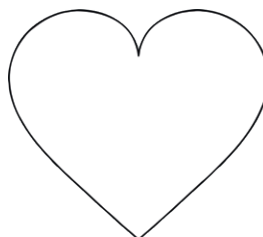

9410

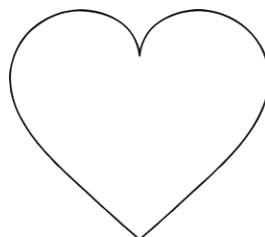

# Ordering Numbers to 1 000 000

Fill in the spaces below with the numbers in order from smallest to largest.

245 452

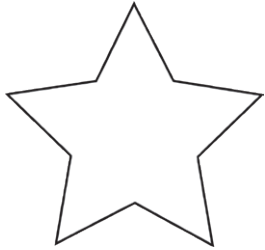

254 245



45 254

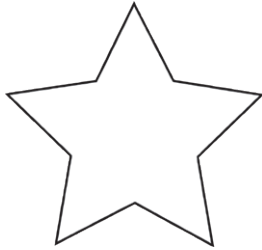

452 524



54 542

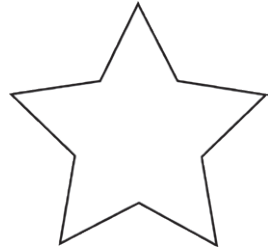

90 900

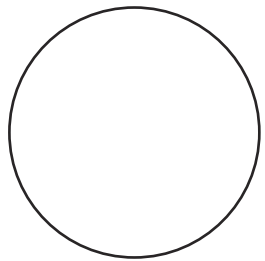

909 009

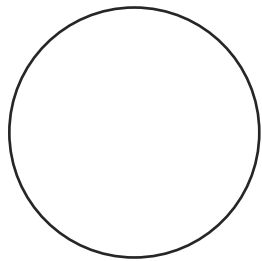

999 909

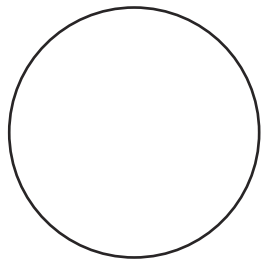

990 009

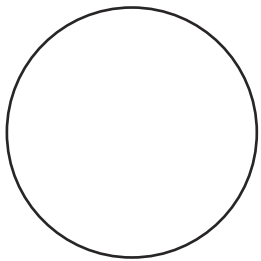

99 900

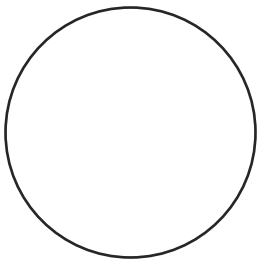

368 863

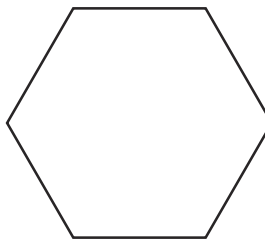

683 836

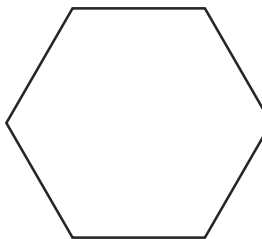

683 863

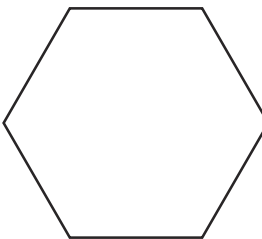

836 368

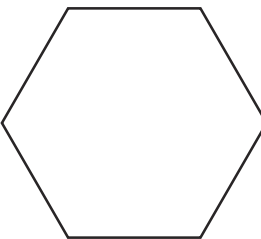

386 386

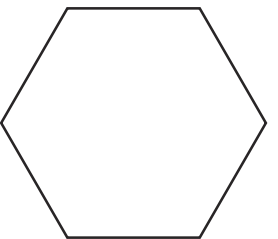

725 500



527 700



77 500



55 200



725 700



110 001

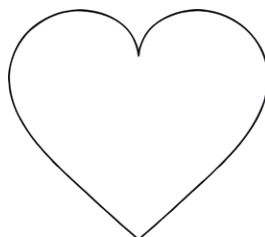

111 010

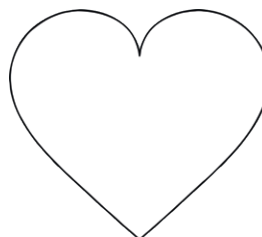

11 110

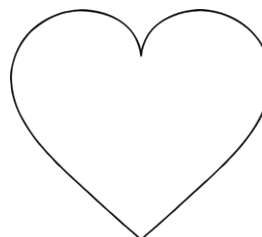

111 101

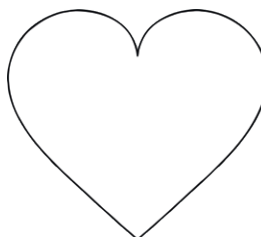

110 100

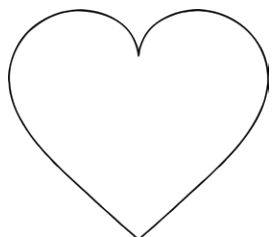

# Writing Numbers to 1 000 000 in Words



Write the following words in numbers:

23 443	Twenty-three thousand, four hundred and forty-three
51 623	
78 785	
33 091	
60 696	
402 341	
589 130	
645 099	
840 781	
709 118	
112 098	
245 590	
390 519	
101 010	



# Writing Numbers to 1 000 000 in Numbers



Write the following words in numbers:

Two hundred and forty-five thousand, eight hundred and forty-six	245 846
Six hundred thousand, seven hundred and thirty-two	
Nine hundred and thirteen thousand, five hundred and forty-one	
Seven hundred and fifteen thousand, two hundred and twenty-eight	
Four hundred and six thousand, seven hundred and ninety-four	
Nine hundred and thirty-six thousand, two hundred and fifty-five	
One hundred and seventeen thousand and four	
Five hundred and thirty-five thousand, seven hundred and six	
Two hundred thousand and twenty-two	
Four hundred and eighty-eight thousand and sixty	
Eight hundred and forty-eight thousand, nine hundred and three	
Nine hundred and ninety-one thousand, one hundred and nineteen	
One hundred and ninety-nine thousand, nine hundred and nineteen	
Five hundred and fifteen thousand, one hundred and fifty-one	

# Writing Numbers to 1 000 000 in Words and Numbers



Write the following words in words and in numbers:

	56 601
	90 452
Two hundred and fourteen thousand, three hundred and twelve	
Six hundred and fourteen thousand and fifty-nine	
	345 327
Four hundred thousand, two hundred and twelve	
Eight hundred and eight thousand, eight hundred and eight	
	880 880
	666 000
Six hundred and sixteen thousand, one hundred and sixty-one	
	797 779
Three hundred and thirty seven thousand and thirty seven	
	340 819
Three hundred and thirty-seven thousand and thirty-seven	

# Counting in Multiples of 10

Work out the correct numbers and then find the number trail in the grid below by counting backwards in 30s from the start each time.

535 787 + 10	<input type="text"/>	+10	<input type="text"/>	+10	<input type="text"/>	+10	<input type="text"/>	+10	<input type="text"/>
879 213 + 20	<input type="text"/>	+20	<input type="text"/>	+20	<input type="text"/>	+20	<input type="text"/>	+20	<input type="text"/>
756 128 + 50	<input type="text"/>	+50	<input type="text"/>	+50	<input type="text"/>	+50	<input type="text"/>	+50	<input type="text"/>
919 399 + 60	<input type="text"/>	+60	<input type="text"/>	+60	<input type="text"/>	+60	<input type="text"/>	+60	<input type="text"/>
754 321 - 10	<input type="text"/>	-10	<input type="text"/>	-10	<input type="text"/>	-10	<input type="text"/>	-10	<input type="text"/>
134 094 - 70	<input type="text"/>	-70	<input type="text"/>	-70	<input type="text"/>	-70	<input type="text"/>	-70	<input type="text"/>

START 394 432	394 492	394 585	394 705	394 505	394 805	394 905
394 118	394 402	394 372	394 625	394 957	394 891	394 635
394 292	394 312	394 342	394 302	394 645	394 665	394 232
394 888	394 282	394 485	394 499	394 680	394 685	394 605
394 578	394 252	394 222	394 192	394 102	394 072	394 042
393 565	393 798	393 411	394 162	394 132	393 082	394 012
393 565	393 166	393 374	393 641	393 445	393 052	FINISH 393 982

# Counting on and Back in Powers of 10

Complete these sequences by counting on or back in powers of 10.

1	546	556	_____	_____	_____
2	478	_____	678	_____	_____
3	4503	_____	_____	4803	_____
4	_____	67	_____	_____	37
5	4904	_____	_____	5204	_____
6	7834	_____	5834	_____	_____
7	12 034	_____	_____	_____	8034
8	23 894	33 894	_____	_____	_____
9	_____	55 903	_____	35 903	_____
10	190 780	_____	390 780	_____	_____
11	345 000	_____	_____	315 000	_____
12	786 457	886 457	_____	_____	_____
13	_____	_____	212 903	112 903	_____
14	1 347 500	_____	_____	_____	1 347 900
15	23 678 340	24 678 340	_____	_____	_____
16	83 900 000	_____	_____	80 900 000	_____
17	_____	_____	510 000 000	520 000 000	_____

# Counting Back in Powers of 10

Count back from the given numbers in 10s (some answers are given)

- 85    75    \_\_\_\_\_    \_\_\_\_\_    \_\_\_\_\_
- 137    \_\_\_\_\_    117    \_\_\_\_\_    \_\_\_\_\_
- 652    \_\_\_\_\_    \_\_\_\_\_    622    \_\_\_\_\_
- 901    \_\_\_\_\_    \_\_\_\_\_    \_\_\_\_\_    861
- 3087    \_\_\_\_\_    \_\_\_\_\_    \_\_\_\_\_    \_\_\_\_\_
- 66 815    \_\_\_\_\_    \_\_\_\_\_    \_\_\_\_\_    \_\_\_\_\_

Spot the error in this sequence:

98 621    98 611    98 601    98 691    98 581

Count back from the given numbers in 100s (some answers are given)

- 431    \_\_\_\_\_    231    \_\_\_\_\_    \_\_\_\_\_
- 900    \_\_\_\_\_    \_\_\_\_\_    600    \_\_\_\_\_
- 3312    3212    \_\_\_\_\_    \_\_\_\_\_    \_\_\_\_\_
- 9028    \_\_\_\_\_    \_\_\_\_\_    \_\_\_\_\_    8628
- 37 920    \_\_\_\_\_    \_\_\_\_\_    \_\_\_\_\_    \_\_\_\_\_
- 209 372    \_\_\_\_\_    \_\_\_\_\_    \_\_\_\_\_    \_\_\_\_\_

Spot the error in this sequence:

192 902    191 802    191 702    191 602    191 502

# Counting Back in Powers of 10 (2)

Count back from the given numbers in 1000s (some answers are given)

1. 4523    \_\_\_\_\_    \_\_\_\_\_    \_\_\_\_\_    523
2. 9000    \_\_\_\_\_    \_\_\_\_\_    6000    \_\_\_\_\_
3. 13 450    12 450    \_\_\_\_\_    \_\_\_\_\_    \_\_\_\_\_
4. 102 342    \_\_\_\_\_    100 342    \_\_\_\_\_    \_\_\_\_\_
5. 398 700    \_\_\_\_\_    \_\_\_\_\_    \_\_\_\_\_    \_\_\_\_\_
6. 1 341 299    \_\_\_\_\_    \_\_\_\_\_    \_\_\_\_\_    \_\_\_\_\_

Spot the error in this sequence:

199 636      299 636      300 636      301 636      302 636

Count back from the given numbers in 10 000s (some answers are given)

1. 43 920    33 920    \_\_\_\_\_    \_\_\_\_\_    \_\_\_\_\_
2. 71 302    \_\_\_\_\_    \_\_\_\_\_    41 302    \_\_\_\_\_
3. 90 000    \_\_\_\_\_    \_\_\_\_\_    \_\_\_\_\_    50 000
4. 275 400    \_\_\_\_\_    255 400    \_\_\_\_\_    \_\_\_\_\_
5. 733 450    \_\_\_\_\_    \_\_\_\_\_    \_\_\_\_\_    \_\_\_\_\_
6. 2 620 645    \_\_\_\_\_    \_\_\_\_\_    \_\_\_\_\_    \_\_\_\_\_

Spot the error in this sequence:

3 610 000      3 510 000      3 500 000      3 310 000      3 210 000

# Counting Back in Powers of 10 (3)

Count back from the given numbers in 100 000s (some answers are given)

1. 690 382    \_\_\_\_\_    490 382    \_\_\_\_\_    \_\_\_\_\_
2. 968 900    \_\_\_\_\_    \_\_\_\_\_    \_\_\_\_\_    568 900
3. 1 220 765    1 120 765    \_\_\_\_\_    \_\_\_\_\_    \_\_\_\_\_
4. 2 400 000    \_\_\_\_\_    \_\_\_\_\_    2 100 000    \_\_\_\_\_
5. 6 256 923    \_\_\_\_\_    \_\_\_\_\_    \_\_\_\_\_    \_\_\_\_\_
6. 14 170 000    \_\_\_\_\_    \_\_\_\_\_    \_\_\_\_\_    \_\_\_\_\_

Spot the error in this sequence:

52 900 000    51 900 000    51 800 000    49 900 000    48 900 000

Count back from the given numbers in 1 000 000s (some answers are given)

1. 4 800 000    \_\_\_\_\_    \_\_\_\_\_    1 800 000    \_\_\_\_\_
2. 7 034 200    \_\_\_\_\_    5 034 200    \_\_\_\_\_    \_\_\_\_\_
3. 12 945 929    11 945 929    \_\_\_\_\_    \_\_\_\_\_    \_\_\_\_\_
4. 37 803 549    \_\_\_\_\_    \_\_\_\_\_    \_\_\_\_\_    33 803 549
5. 62 900 310    \_\_\_\_\_    \_\_\_\_\_    \_\_\_\_\_    \_\_\_\_\_
6. 231 500 000    \_\_\_\_\_    \_\_\_\_\_    \_\_\_\_\_    \_\_\_\_\_

Spot the error in this sequence:

778 100 000    777 100 000    776 100 000    776 900 000    774 100 000

# Counting Forwards and Backwards with Positive and Negative Whole Numbers

I can count forwards and backwards with positive and negative whole numbers.

1. Continue this sequence. Colour in the thermometer to match your sequence.

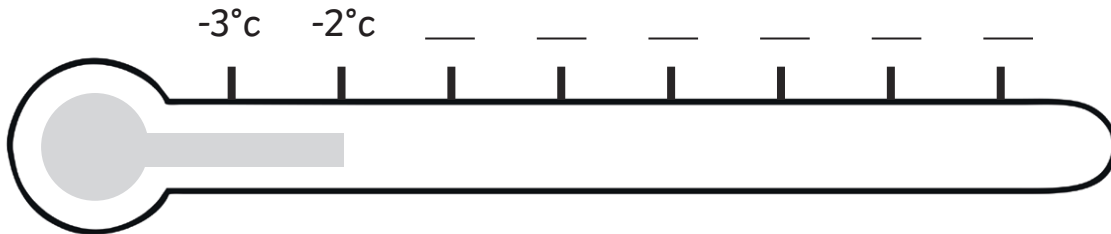

2. Shade the thermometer lightly up to 20°C. Count backwards to continue this sequence and rub out as you go.

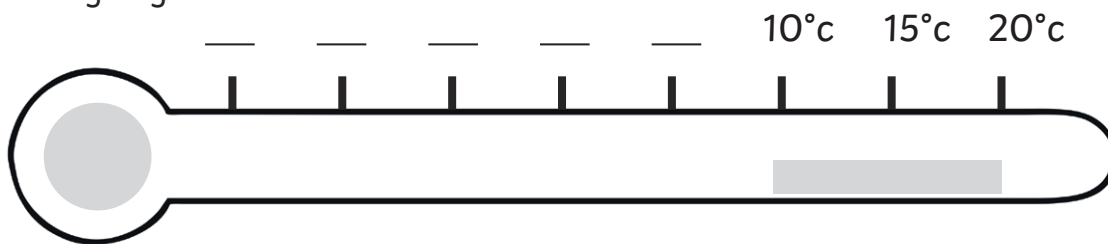

3. Look at the ice lolly on the stick. Count forwards to complete the sequence. As you count forwards draw the ice lolly as it continues to melt in the rising temperature. You should have nothing remaining in the last picture.

-7°C	-4°C								

4. Continue this sequence backwards. As the temperature drops with each step, draw an extra item of clothing on the person.

\_\_\_\_\_ 11°C 17°C 23°C





5. Figure out the step in each sequence then use the number line below to help you count forwards and backwards to complete them.

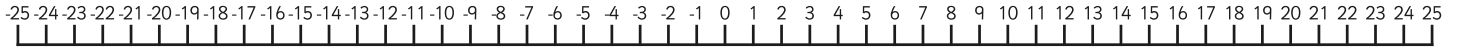

- A. \_\_\_ \_\_\_ \_\_\_ \_\_\_ \_\_\_ 3 5 7
- B.  $-17^{\circ}\text{C}$   $-12^{\circ}\text{C}$   $-7^{\circ}\text{C}$  \_\_\_ \_\_\_ \_\_\_ \_\_\_ \_\_\_
- C. \_\_\_ \_\_\_ \_\_\_ \_\_\_ 4 9 \_\_\_ 19
- D. -31 \_\_\_ \_\_\_ \_\_\_ \_\_\_ \_\_\_ 17 25
- E. \_\_\_ \_\_\_ \_\_\_  $-\text{£}6$   $-\text{£}2$  \_\_\_ \_\_\_ \_\_\_
- F. \_\_\_ \_\_\_ \_\_\_ \_\_\_ \_\_\_  $11^{\circ}\text{C}$   $15.5^{\circ}\text{C}$   $20^{\circ}\text{C}$

6. Look at the temperatures for these cities.  
Write the name of the warmest place in the box.



A.	New York	Moscow	Warmest
	$-3^{\circ}\text{C}$	$-1^{\circ}\text{C}$	
B.	Reykjavik	London	Warmest
	$-10^{\circ}\text{C}$	$-3^{\circ}\text{C}$	
C.	Stockholm	Edinburgh	Warmest
	$-4^{\circ}\text{C}$	$-1^{\circ}\text{C}$	
D.	Minsk	St. Petersburg	Warmest
	$-15^{\circ}\text{C}$	$-17^{\circ}\text{C}$	

# The Nearest 1000

Match the number, how the number is rounded, and the number to which it is rounded.  
One has been done for you:

13 790	Nearest 100 000	30 000
29 078	Nearest 100 000	800 000
34 972	Nearest 1000	29 000
145 000	Nearest 10 000	978 000
563 359	Nearest 10 000	600 000
607 450	Nearest 10 000	10 000
784 902	Nearest 1000	150 000
978 236	Nearest 10 000	610 000

## Challenge

Make your own for a friend to check. Some boxes have been completed or partly completed already. You need to include the arrows.

	Nearest	
56 014	Nearest	35 000
	Nearest 10	
	Nearest	
455 023	Nearest 100	600 000
	Nearest	
	Nearest 1000	

# The Nearest 10 000

Write the ten thousands either side of the given number and mark it approximately on the number line. Then circle the 10 000 to which the given number is closer. (Remember 5 (5000) goes up).

a. 43 930



b. 67 509



c. 30 591



d. 45 662



e. 89 014



f. 12 300



g. 24 677



h. 476 545



i. 135 314



j. 270 013



k. 349 718



l. 455 450



# The Nearest 10 000 (2)

Round the following numbers to the nearest 10 000.

16 023 →	120 532 →	195 870 →
27 467 →	244 665 →	200 287 →
49 501 →	315 500 →	375 828 →
62 090 →	455 838 →	199 777 →
76 327 →	626 112 →	471 727 →
92 105 →	731 008 →	999 300 →

Round the following populations to the nearest 10 000.

Places	Population	To the nearest 10 000
Iceland	317 900	
Bahamas	346 000	
Malta	416 333	
Samoa	179 000	
Maldives	314 000	
Solomon Islands	536 000	
Guyana	761 000	
Cyprus	801 851	
fiji	854 000	

# The Nearest 100 000

Write the ten thousands either side of the given number and mark it approximately on the number line. Then circle the 10 000 to which the given number is closer. (Remember 5 (5000) goes up).

a. 302 456



b. 745 900



c. 201 489



d. 485 200



e. 350 891



f. 120 780



g. 540 400



h. 267 080



i. 782 000



j. 932 910



k. 590 800



l. 967 302



# The Nearest 100 000 (2)

Round the following numbers to the nearest 100 000.

116 023      →	195 870      →
527 467      →	900 287      →
419 501      →	375 828      →
572 090      →	199 777      →
736 327      →	571 727      →
825 105      →	999 300      →

Round the following populations to the nearest 100 000.

Places	Population	To the nearest 10 000
Iceland	317 900	
Bahamas	346 000	
Malta	416 333	
Samoa	179 000	
Maldives	314 000	
Solomon Islands	536 000	
Guyana	761 000	
Cyprus	801 851	
fiji	854 000	

# Counting Forwards and Backwards in Powers of 10 Word Problems

Answer the following questions:

1. What number is 1000 more than 3683?
2. How many less is 5693 than 5703?
3. What number is 10 000 less than 1 234 508?
4. If I add 100 to a number I get 3467. What number did I start with?
5. 23 890 is how many more than 13 890?
6. What number is 100 more than 45 901?
7. Add 10 000 to 270 801.
8. If I subtract 1000 from a number I get 19 230. What number did I start with?
9. What number is 100 000 more than 671 023?
10. Subtract 1 000 000 from 30 782 901.

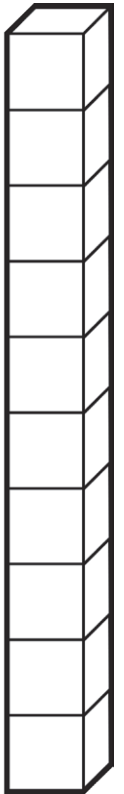

Write the following as calculations and solve them.

- A. 7503 cars go over a bridge in February. In March, 1000 more cars go over the bridge than in February. How many go over the bridge in March?
- B. There are 30 903 books in a mobile library collection, but 1000 of these are on loan. How many books are left in the library?
- C. A girl wins £10 000 for winning a tennis competition. She has now won £35 600 in prize money altogether. How much had she won before winning the £10 000?
- D. A car has 34 678 miles on the milometer, but it had already travelled 100 000 miles. How many miles has it travelled altogether?
- E. A factory makes 305 800 glass bottles a day in March, which is 10 000 more than it made in February. How many bottles did it used to make each day in February?

# The Nearest 10 000 and 100 000

Solve the following word problems, rounding the answer as instructed.

1. A supermarket sells 143 687 litres of milk in one month.

How many litres is this to the nearest 10 000 and nearest 100 000?



2. There are 487 245 spectators at all the Premier League football matches on a Saturday.

How many is this to the nearest 10 000 and nearest 100 000?

3. A newspaper reports that about 160 000 people attended a parade.

How is this rounded and what is the range of the precise attendance?



4. 529 876 adults and 225 621 children visit a zoo in one year.

To the nearest 10 000 and nearest 100 000, how many people visit the zoo altogether?

5. A supermarket has 534 348 tins of tomatoes at a distribution centre. It sends out 67 782 in one shipment.

To the nearest 10 000, how many will be left?



6. A call centre receives about 75 000 calls per day.

To the nearest 10 000, how many calls does it receive in a working week (5 days)?

7. A swimming pool has 324 923 swimmers in the main pool and 591 023 swimmers in the leisure pool in one year.

To the nearest 100 000, how many swimmers do both pools get over the whole year?

8. A lorry driver travels 256 349 miles in one year, and 289 012 miles in the following year.

To the nearest 10 000 and 100 000, how many miles does the driver travel in both years?

## Challenge

What happens if you round the numbers in the questions, then calculate the answers?



# Word Problems Involving Negative Numbers

I can solve word problems involving negative numbers

Answer these questions. Adding numbers to the blank number lines may help you.

1. The temperature at 6 p.m is  $8^{\circ}\text{C}$ , at 6 a.m. the next morning the temperature has dropped to  $-7^{\circ}\text{C}$ . How many degrees has the temperature fallen by?

2. If you point to 11 on a number line and then count back 18, which number do you get to?

3. The elevator in a skyscraper travels from floor 19 to the underground car park on level -4. How many floors has it descended?

4. An overdraft is a facility which means you can have a negative amount of money in your bank account. If a saver balance of  $-\pounds 19$  and then paid  $\pounds 30$  into his bank account, how much would he have available to spend?

5. In a quiz, a team scores 2 points for each correct answer and loses 5 points for each wrong answer. From the start of a game, a team gets 4 questions in a row correct, but then gets two questions wrong. How many points do they have?

6. The temperature in New York is  $4^{\circ}\text{C}$  when the Christmas lights are switched on. By 9 a.m. the next day, the temperature has fallen by  $11^{\circ}\text{C}$ . What is the new temperature?

7. Mrs. Jones buys a pair of skis and pays for them with her debit card. The skis cost  $\pounds 85$  and she had  $\pounds 50$  in her account. What is her new balance?

8. Mr. Davies overspends during the month of September and goes  $\pounds 247$  overdrawn. How much does he have left after his October wages of  $\pounds 847$  are paid into his account?

# Roman Numerals Worksheet

Translate these Roman numerals. Don't forget to show your working out!

1. MD \_\_\_\_\_

4. CXVI \_\_\_\_\_

2. MCD \_\_\_\_\_

5. DCLX \_\_\_\_\_

3. XXXIV \_\_\_\_\_

6. CXIII \_\_\_\_\_

Write these numbers in Roman numerals.

1. 35 \_\_\_\_\_

4. 283 \_\_\_\_\_

2. 100 \_\_\_\_\_

5. 570 \_\_\_\_\_

3. 99 \_\_\_\_\_

6. 27 \_\_\_\_\_

Arrange these numbers in size order.

XXXV, XL, XXX, LX, LV, L, XLV, LXV

\_\_\_\_\_, \_\_\_\_\_, \_\_\_\_\_, \_\_\_\_\_, \_\_\_\_\_, \_\_\_\_\_, \_\_\_\_\_, \_\_\_\_\_

CL, CCC, CCL, C, CD, CC, L, CCCL

\_\_\_\_\_, \_\_\_\_\_, \_\_\_\_\_, \_\_\_\_\_, \_\_\_\_\_, \_\_\_\_\_, \_\_\_\_\_, \_\_\_\_\_

Count in hundreds from one hundred.

C, CC, \_\_\_\_\_, \_\_\_\_\_, D, \_\_\_\_\_, \_\_\_\_\_, \_\_\_\_\_, \_\_\_\_\_

Count in five hundreds from five hundred.

D, \_\_\_\_\_, \_\_\_\_\_, \_\_\_\_\_, MMD, \_\_\_\_\_, \_\_\_\_\_

Complete these calculations.

1. CD + DC = \_\_\_\_\_

4. XL + LX = \_\_\_\_\_

2. VI + IV = \_\_\_\_\_

5. CM + MC = \_\_\_\_\_

3. XI + IX = \_\_\_\_\_

6. CX + XC = \_\_\_\_\_

# Roman Numerals - Recognising Years

I can convert years written in Roman numerals.

The rules that must be followed for accurate use of Roman numerals are as follows:

1. Symbols are written from left to right in value order.
2. To avoid having four characters in a row, some characters can be subtracted from others when placed BEFORE them.
3. I placed before V or X indicates one less.
4. X placed before L or C indicates ten less.
5. C placed before D or M indicates a hundred less.

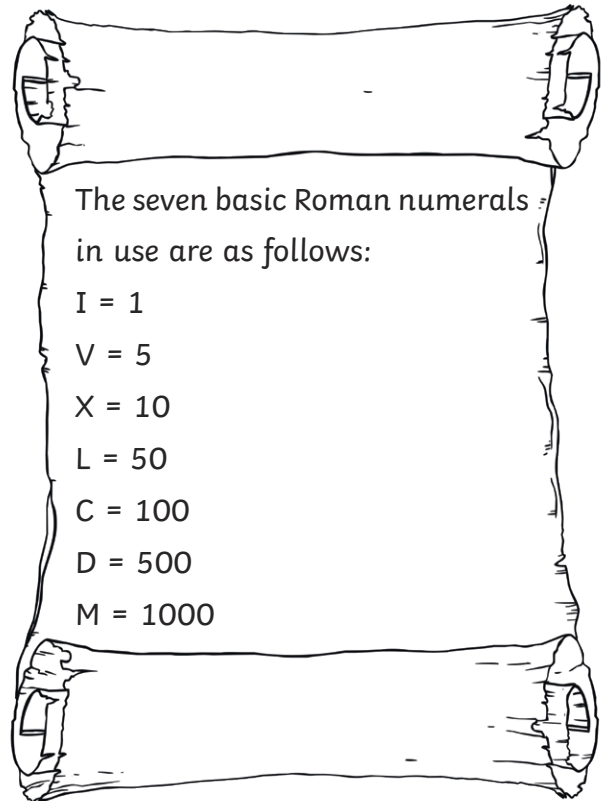

This is how we would translate the year 1971.

1000	900	70	1	<b>1971</b>
M	CM	LXX	I	<b>MCMLXXI</b>

1. Work out each of the following years in Roman numerals.

A.

1000	900	90	9	1999

B.





2000	0	0	5	2005

C.

1000	900	50	6	1956

D.	1000	800	80	8	1888

2. Work out which year the following historical figures were born.

Who	Roman Numeral Year of Birth	Translation
 Marie Curie	MDCCLXVI I	
 Winston Churchill	MDCCCLXXIV	
 Queen Elizabeth	MCMXXVI	
 John Lennon	MCMXL	
 You!		

### Challenge

Can you work out how old these people were when they died and who lived the longest life?

