

Trigonometry Worksheet.

Find the following **sides** using trigonometry. Don't forget to use SOH-CAH-TOA to decide which ratio you should use. (All units in cm)

1

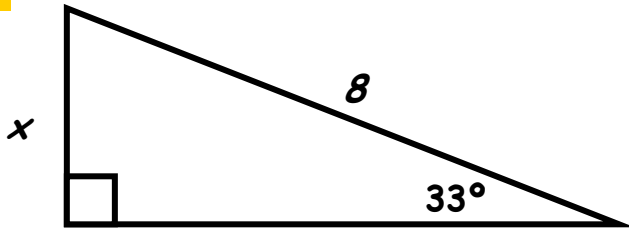

2

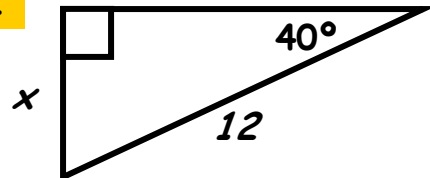

3

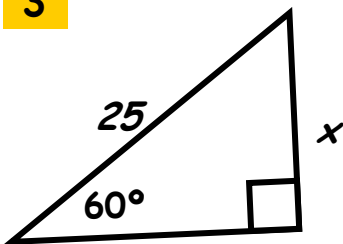

4

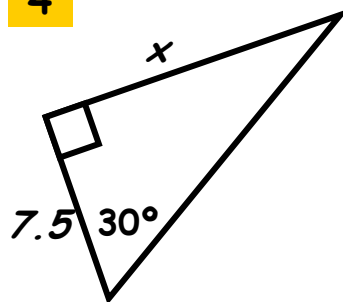

5

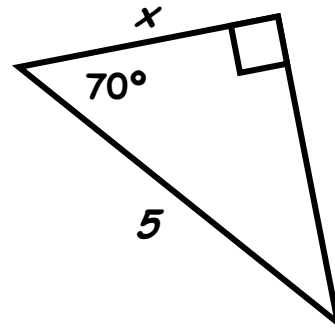

6

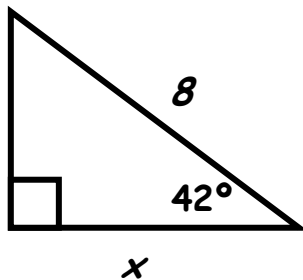

7

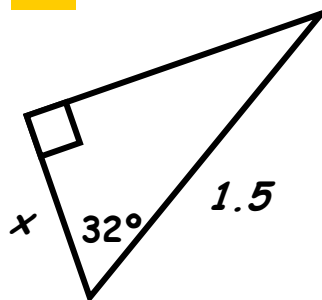

8

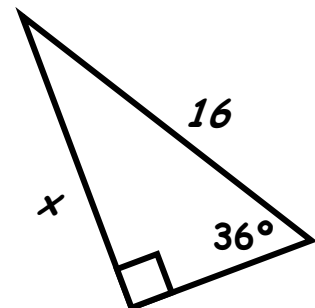

9

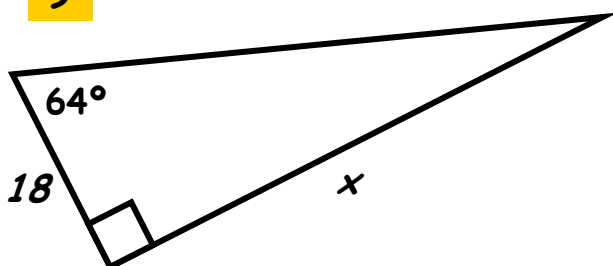

10

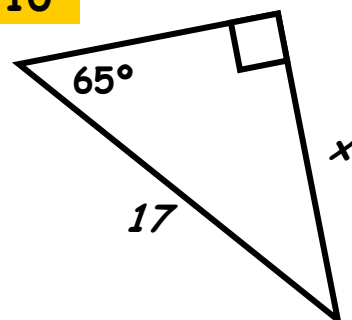

11

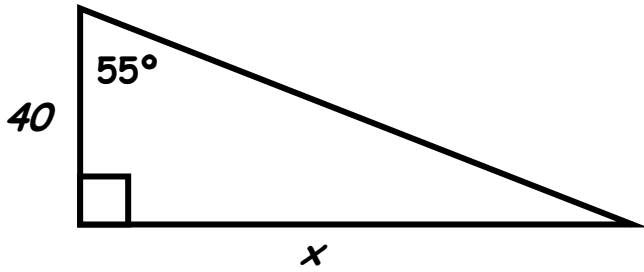

14

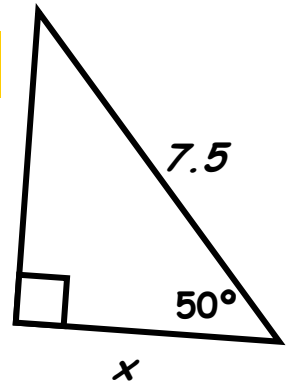

12

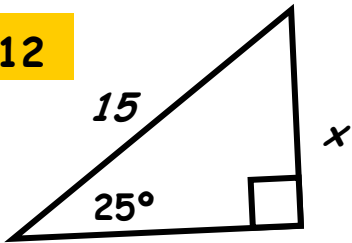

13

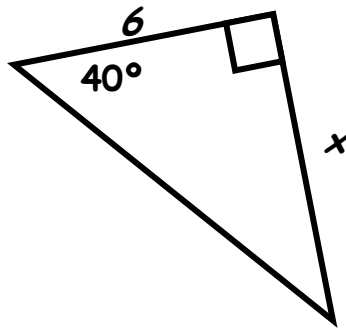

15

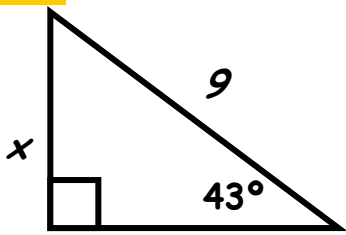

16

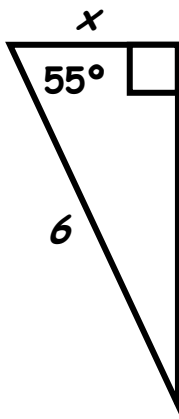

17

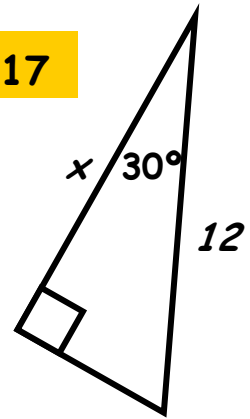

18

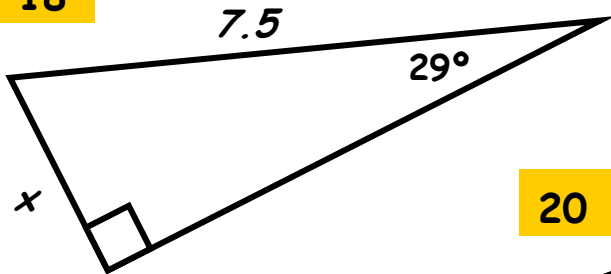

19

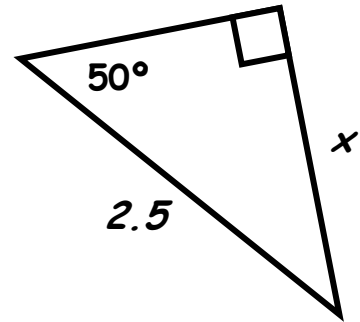

20

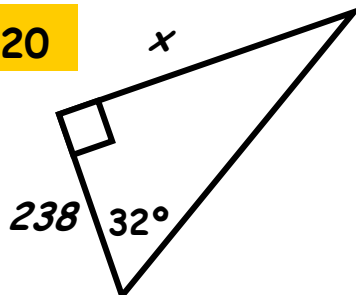

22

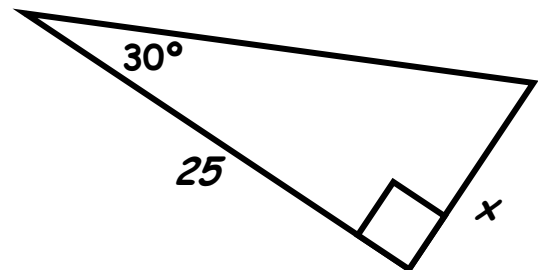

21

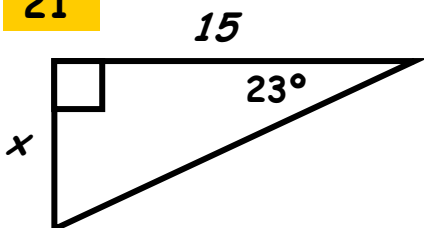

Finding a Side Answers

1. 4.36cm
2. 7.71cm
3. 21.65cm
4. 4.33cm
5. 1.71cm
6. 5.95cm
7. 1.27cm
8. 9.4cm
9. 36.91cm
10. 15.41cm
11. 57.13cm
12. 6.34cm
13. 5.03cm
14. 4.82cm
15. 6.14cm
16. 3.44cm
17. 10.39cm
18. 3.64cm
19. 1.92cm
20. 148.82cm
21. 6.37cm
22. 14.43cm

Trigonometry Worksheet 2

Find the following **Angles** using Trigonometry. Don't forget to use SOH-CAH-TOA. All sides are in cm, but remember when you give your final answer it must be in degrees ($^{\circ}$) since it is the size of an angle you are finding.

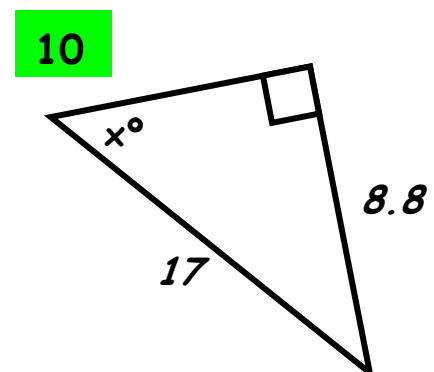
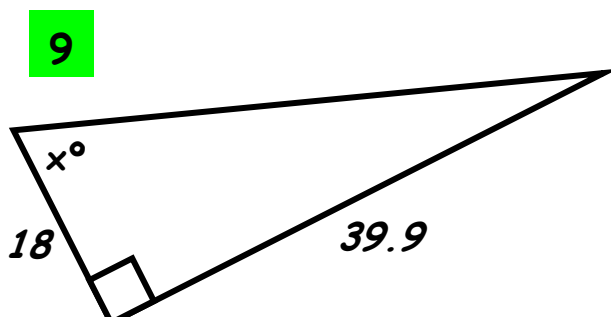
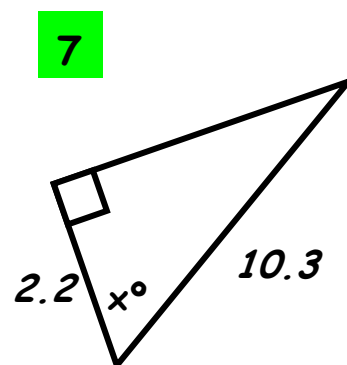
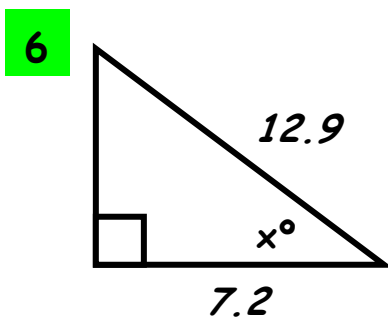
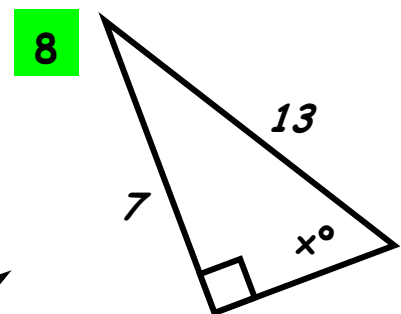
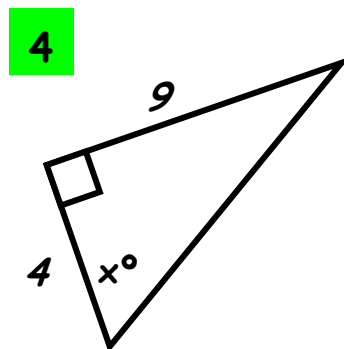
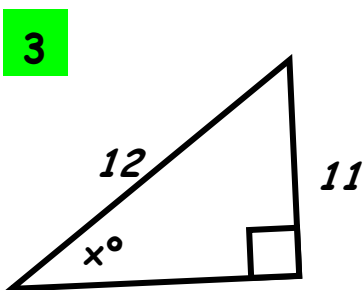
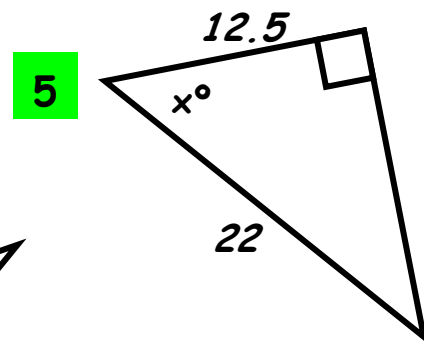
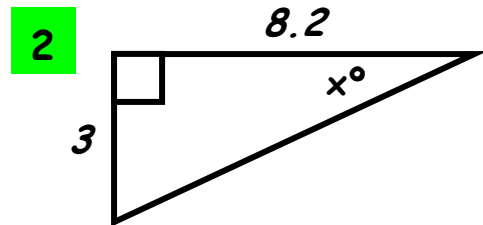
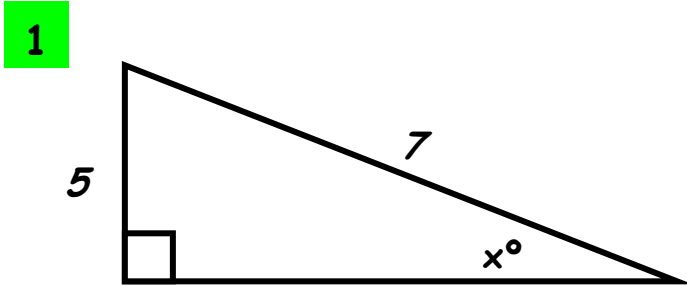

11

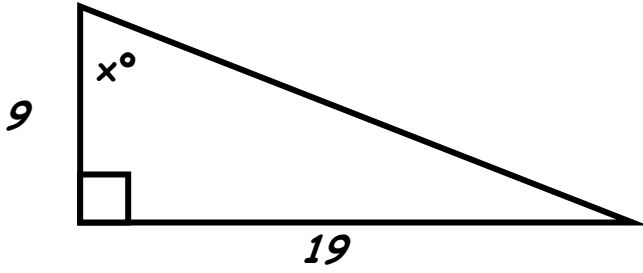

14

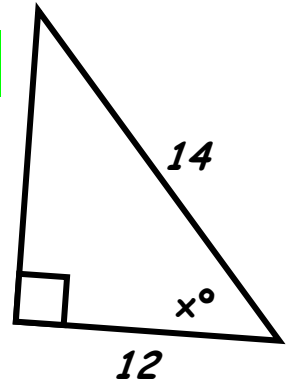

12

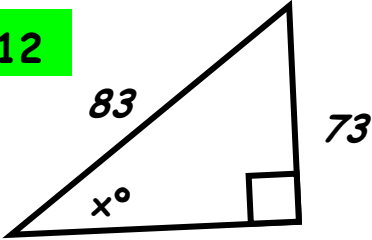

13

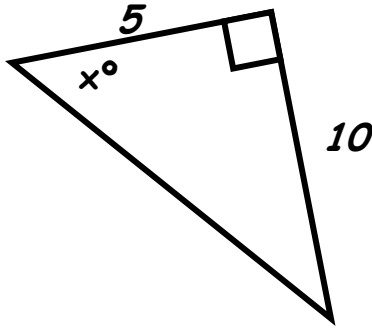

15

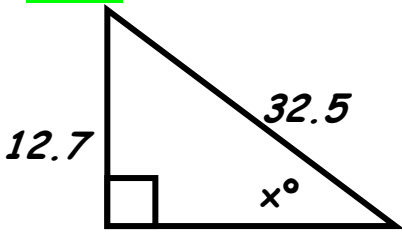

16

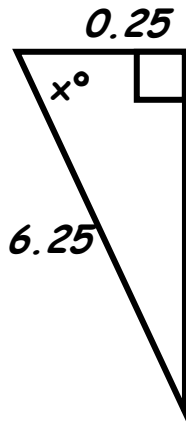

17

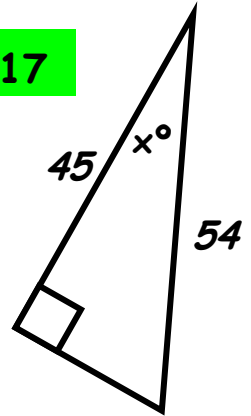

19

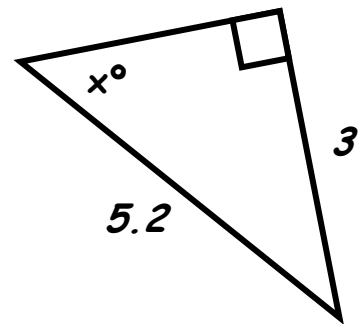

18

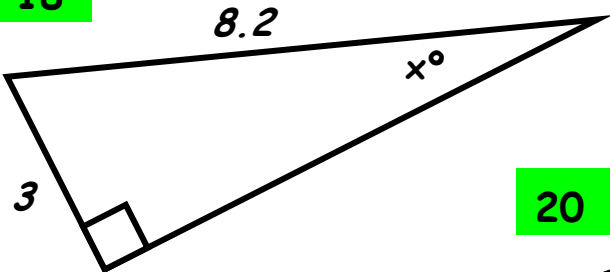

20

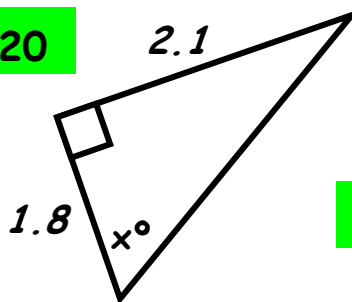

22

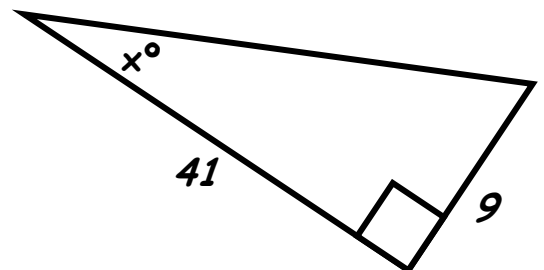

21

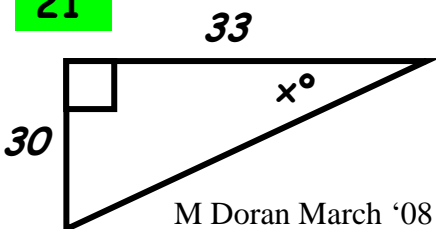

Finding the Angle Answers.

1. 45.6°
2. 20.1°
3. 66.4°
4. 66°
5. 55.4°
6. 56.1°
7. 77.7°
8. 32.6°
9. 65.7°
10. 31.2°
11. 64.7°
12. 61.6°
13. 63.4°
14. 31°
15. 23°
16. 87.7°
17. 33.6°
18. 21.5°
19. 35.2°
20. 49.4°
21. 42.3°
22. 12.4°