

EXERCISES. In which direction must the object be viewed to produce the views shown opposite, taking 'A' as the FRONT VIEW. Put the appropriate letter under the view.

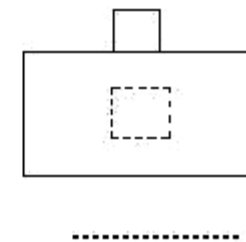
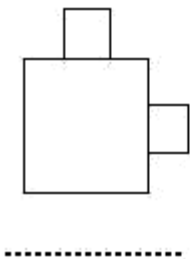
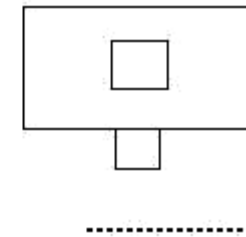
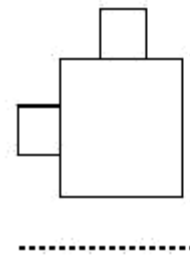
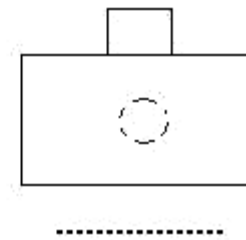
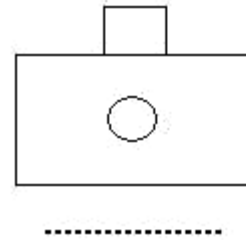
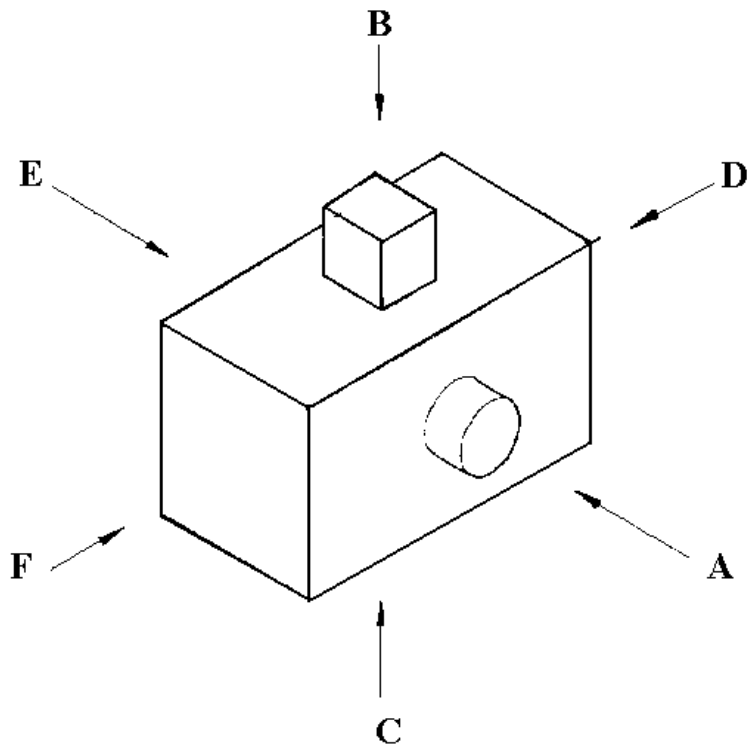

DRG.

ORTHOGRAPHIC PROJECTION

EXERCISE 1

EXERCISES. Study the two drawings and complete the table by matching the numbered surfaces of the orthogonal drawing with the lettered surfaces of the isometric drawing.

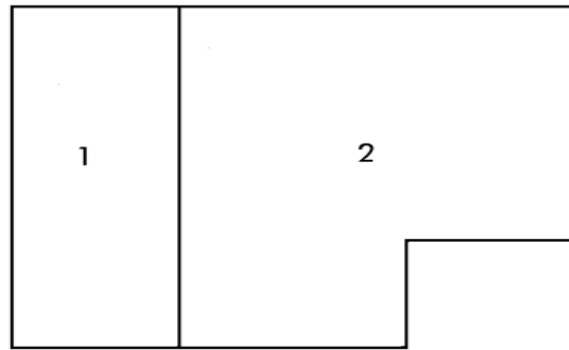

TOP VIEW

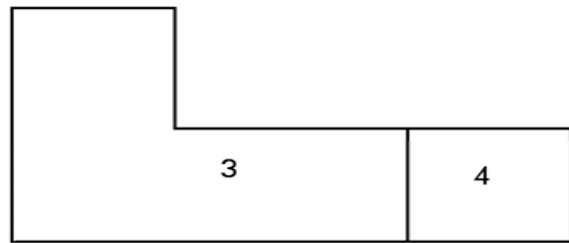

FRONT VIEW



SIDE VIEW

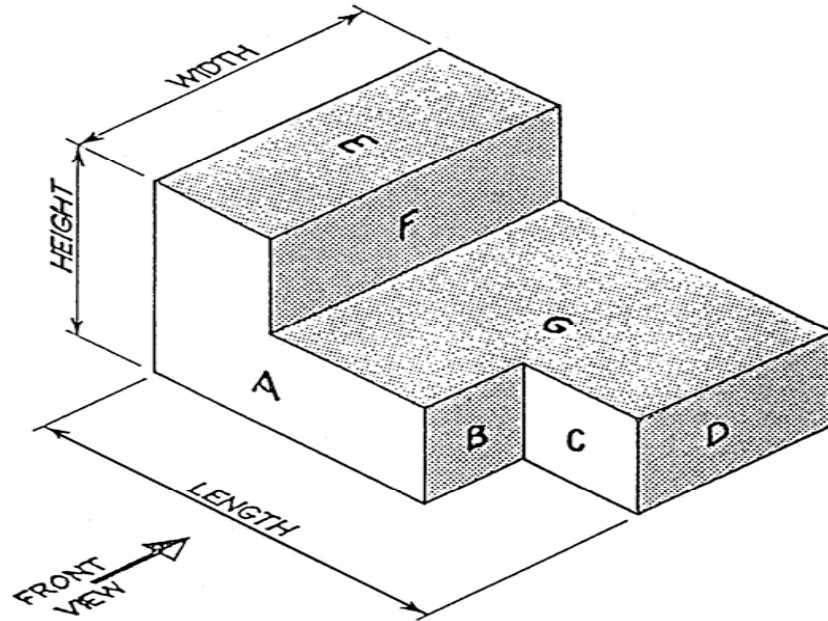

A	B	C	D	E	F	G

DRG. ORTHOGRAPHIC PROJECTION

EXERCISE 2

EXERCISES. Transfer the letters from the isometric drawing onto the same plane surfaces of the orthogonal drawing. Name each view.

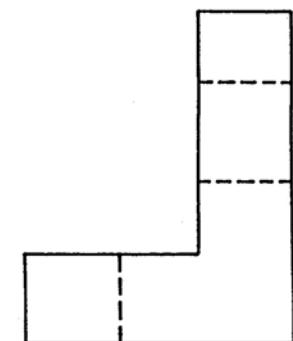
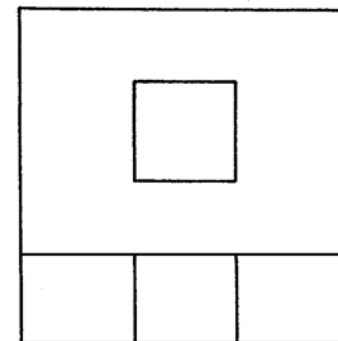
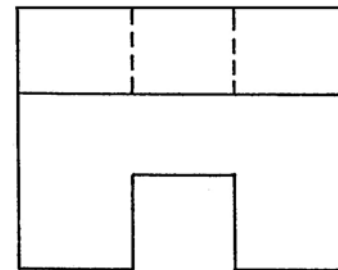
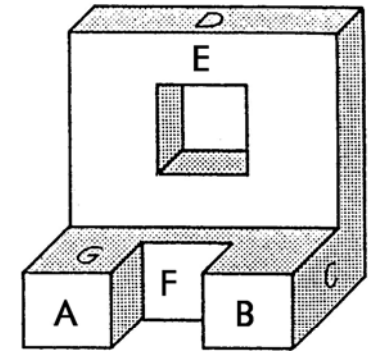
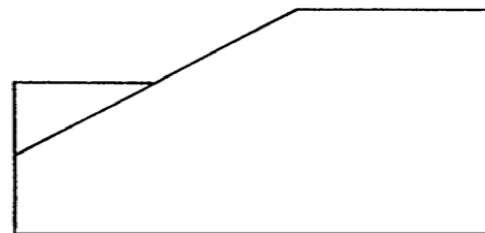
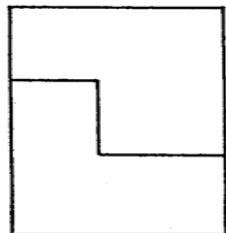
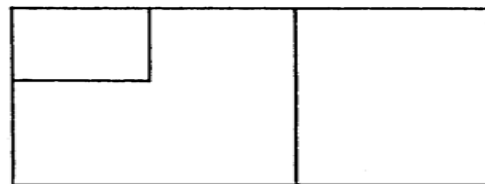
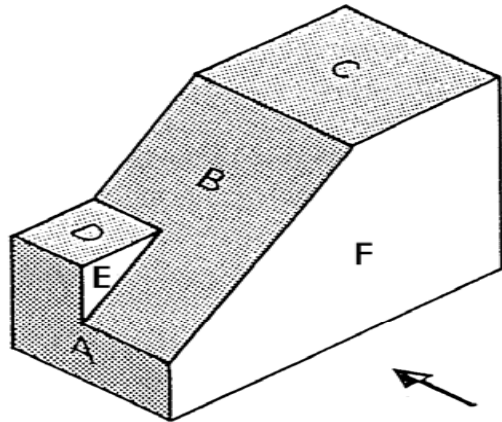

DRG. ORTHOGRAPHIC PROJECTION

EXERCISE 3

EXERCISES. From drawings 1 to 18 opposite select the view which is requested in the table below. Place the number of this view in the

appropriate position in the table.

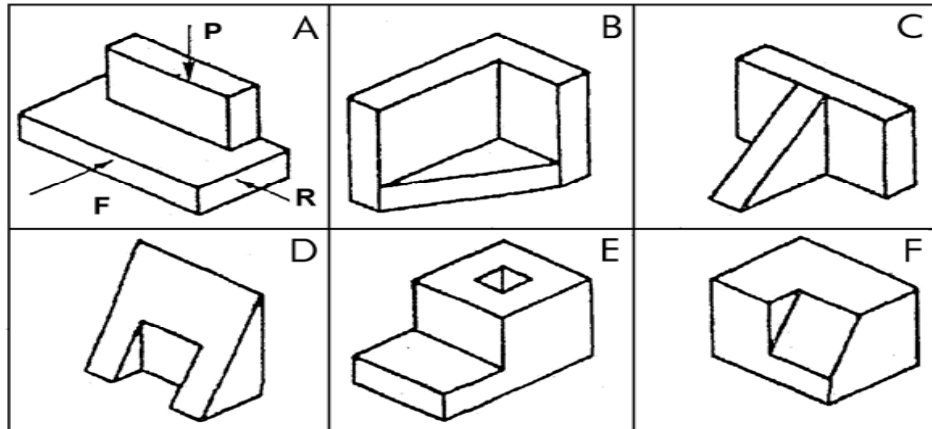

DRAWING	A	B	C	D	E	F
FRONT view in direction of F	10					
PLAN view in direction of P						
SIDE view in direction of R						

1		2		3	
4		5		6	
7		8		9	
10		11		12	
13		14		15	
16		17		18	

EXERCISES. Study the two types and complete the table by matching the numbered orthogonal drawings with the same isometric view.

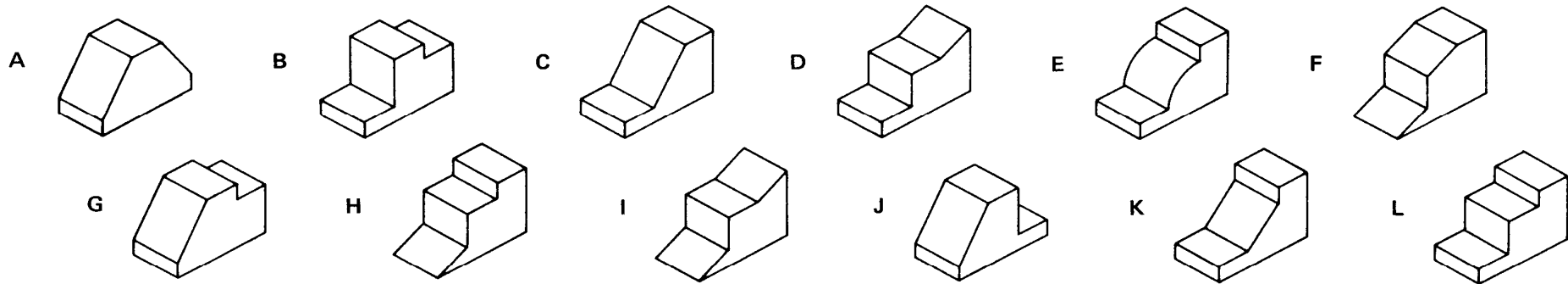
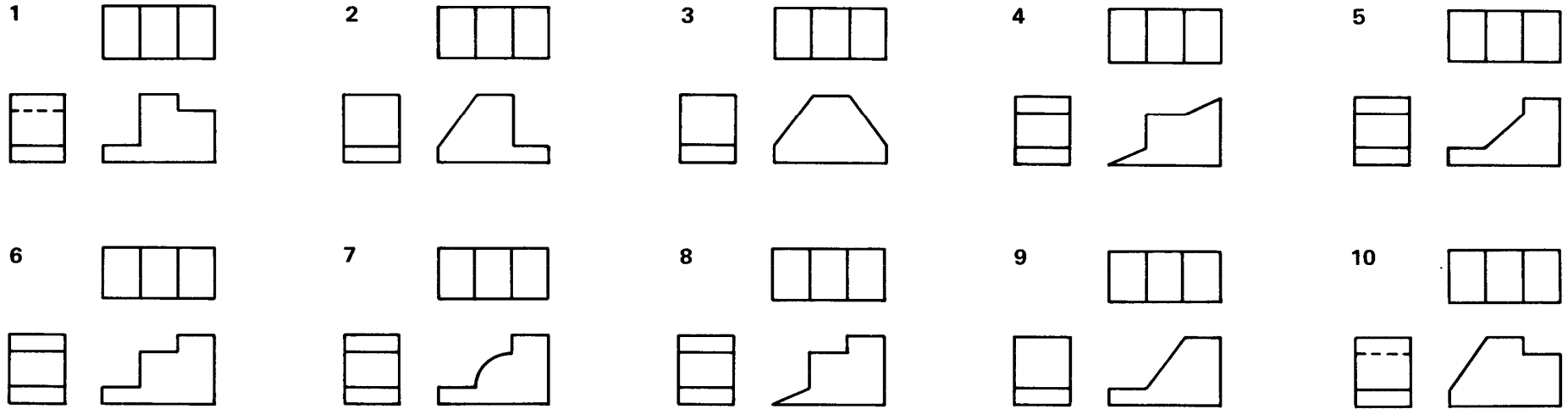

1	2	3	4	5	6	7	8	9	10

DRG. ORTHOGRAPHIC PROJECTION EXERCISE 5

EXERCISES. Study the two types and complete the table by matching the numbered orthogonal drawings with the same oblique view.

G

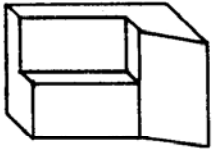

H

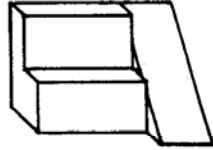

I

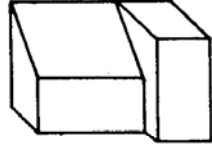

J

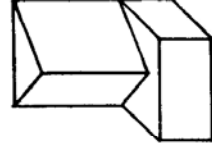

K

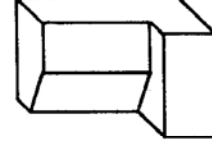

L

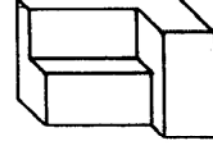

1

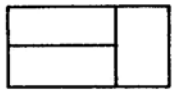

2

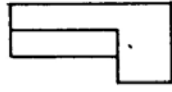

3

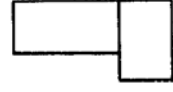

4

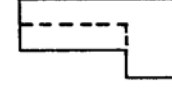

5

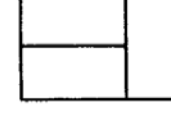
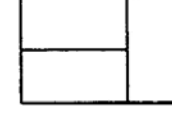
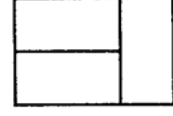
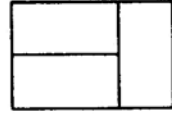
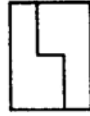
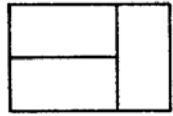
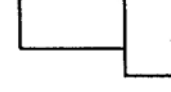

6

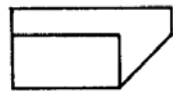

7

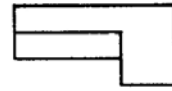

8

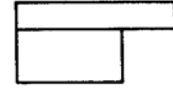

9

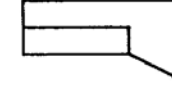

10

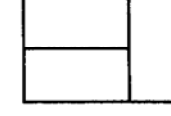
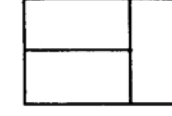
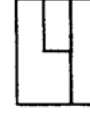
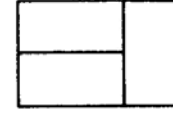
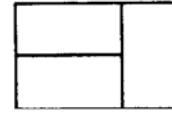
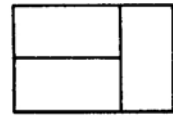
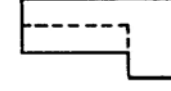

A	B	C	D	E	F	G	H	I	J

DRG.

ORTHOGRAPHIC PROJECTION

EXERCISE 6

EXERCISES. Study the two types and complete the table by matching the numbered orthogonal drawings with the same isometric view.

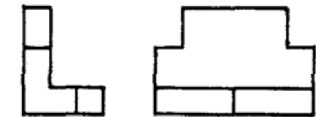
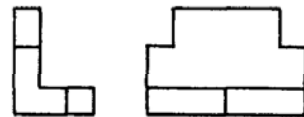
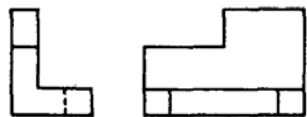
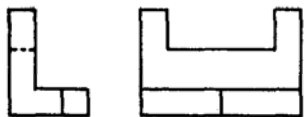
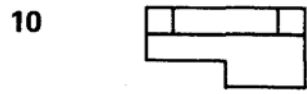
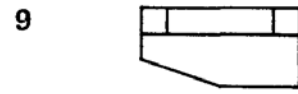
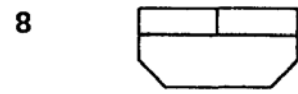
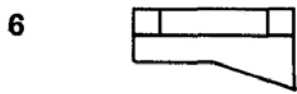
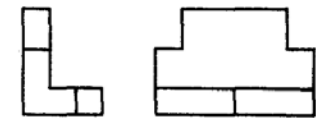
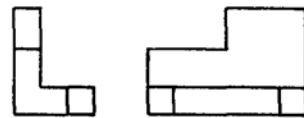
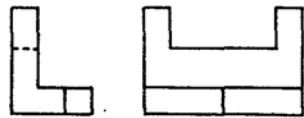
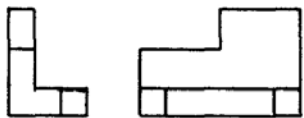
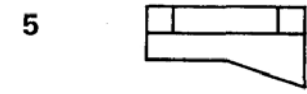
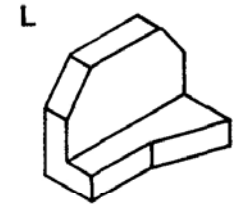
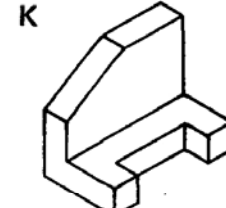
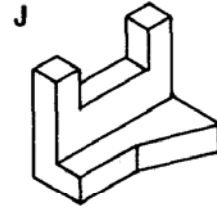
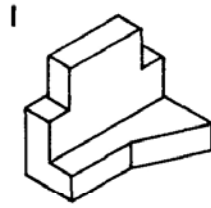
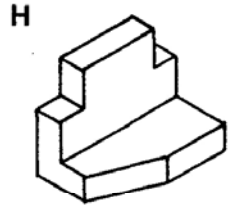
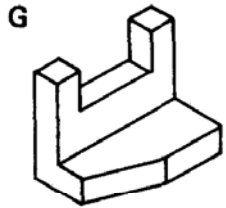

A	B	C	D	E	F	G	H	I	J

DRG.

ORTHOGRAPHIC PROJECTION

EXERCISE 7

EXERCISES. Study the two types and complete the table by matching the numbered orthogonal drawings with the same isometric view.

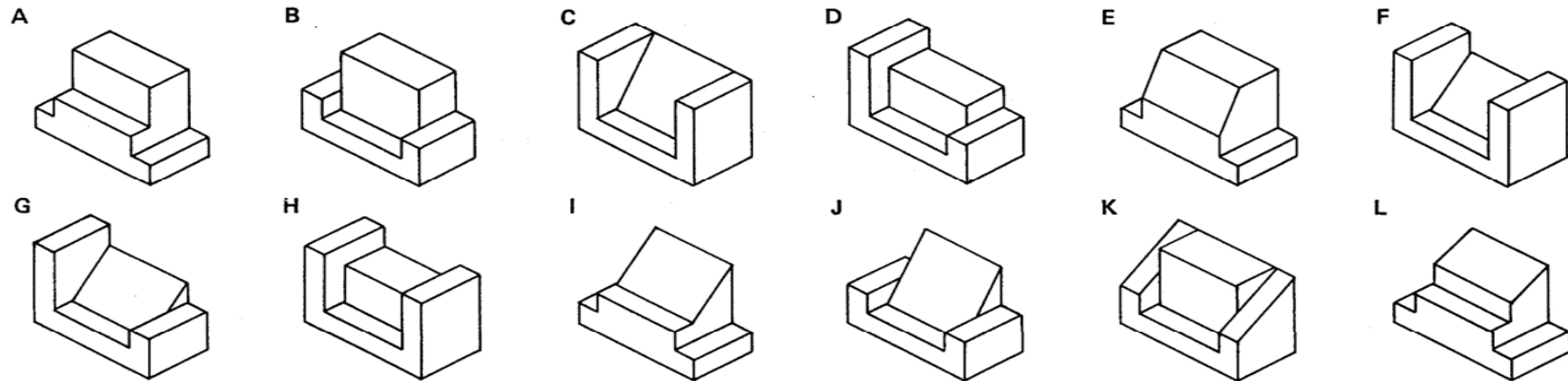
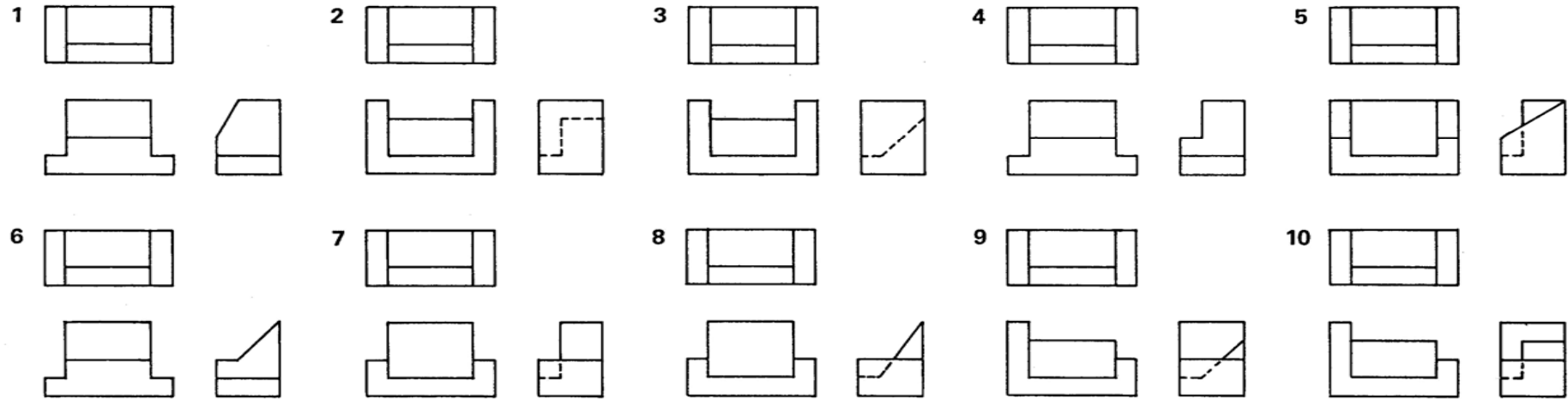

1	2	3	4	5	6	7	8	9	10

DRG. ORTHOGRAPHIC PROJECTION EXERCISE 8

EXERCISES. Study the two types and complete the table by matching the numbered orthogonal drawings with the same isometric view.

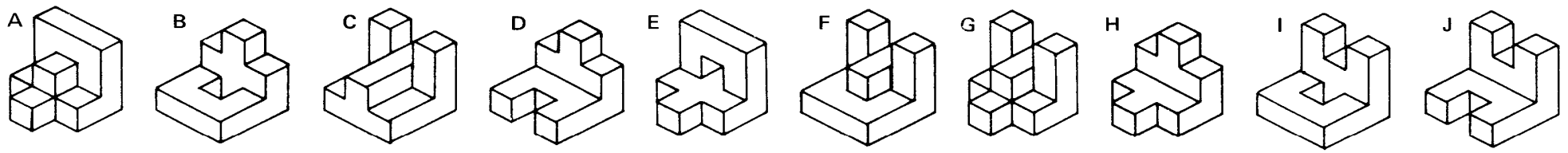
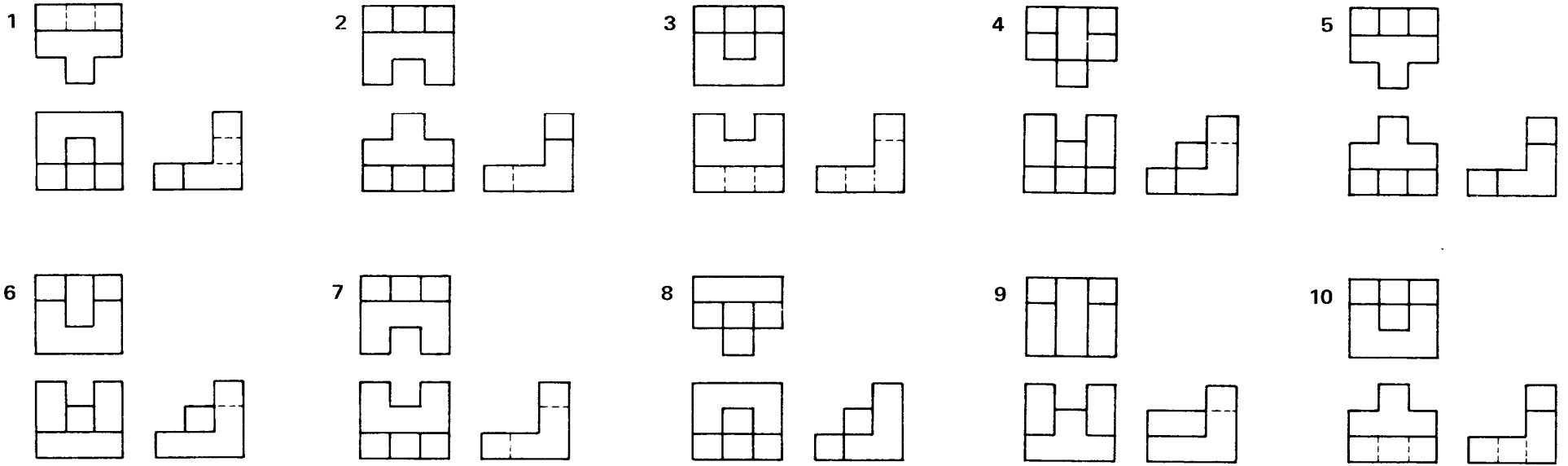

1	2	3	4	5	6	7	8	9	10

DRG. ORTHOGRAPHIC PROJECTION EXERCISE 9

EXERCISES. FREEHAND SKETCHING. Sketch, on the space provided, the first angle projection of the component below.

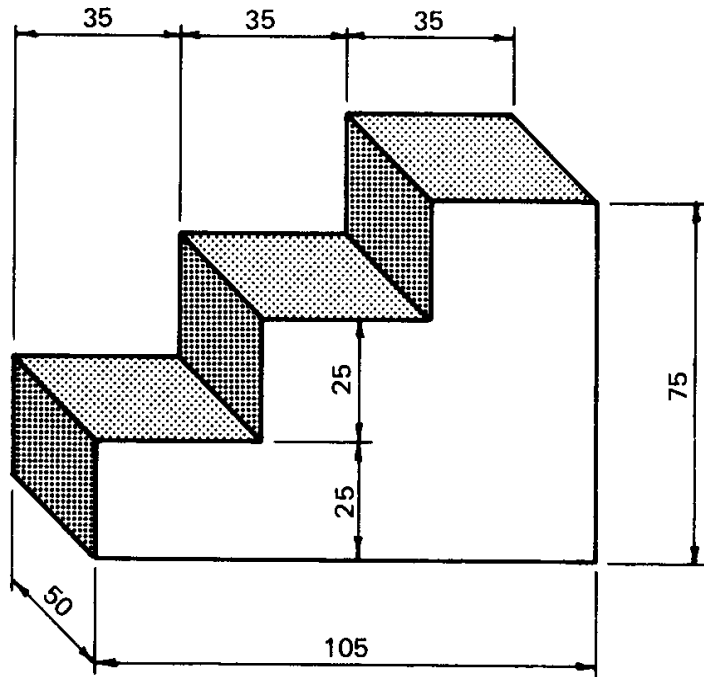

DRG.

ORTHOGRAPHIC PROJECTION

EXERCISE 10

EXERCISES. FREEHAND SKETCHING. Sketch, on the space provided, the first angle projection of the component below.

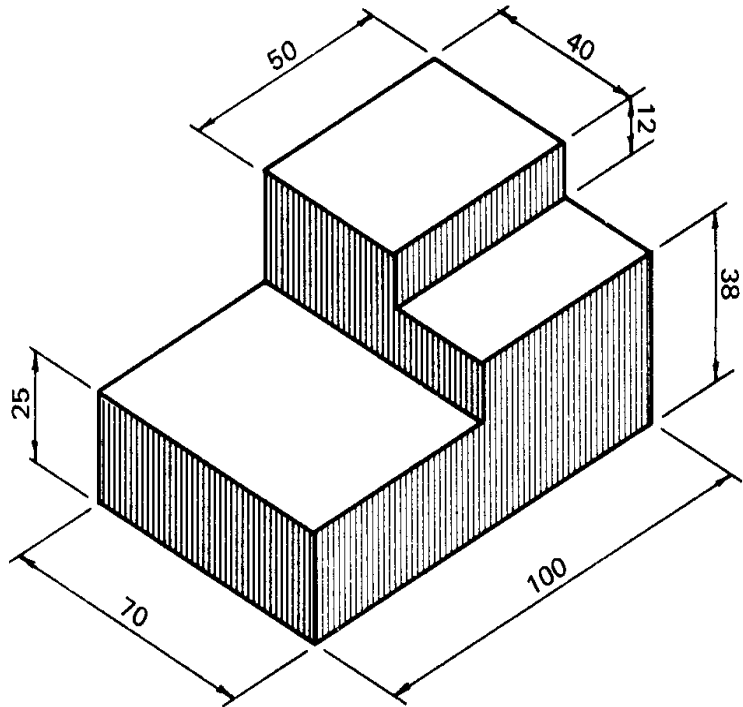

DRG.

ORTHOGRAPHIC PROJECTION

EXERCISE 11

EXERCISES. FREEHAND SKETCHING. Sketch, on the space provided, the third angle projection of the component below.

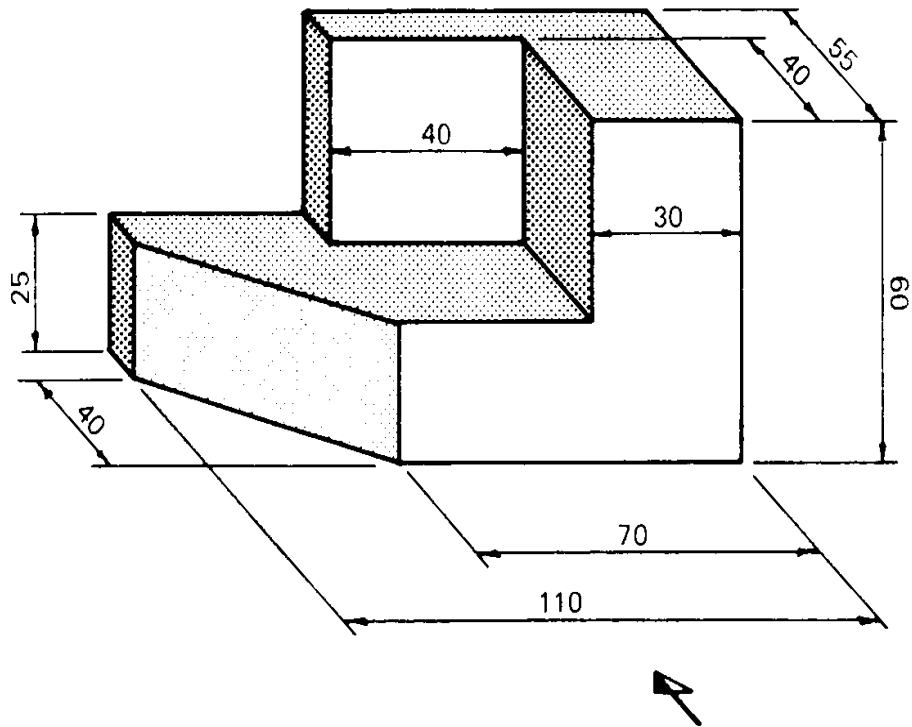

DRG.

ORTHOGRAPHIC PROJECTION

EXERCISE 12

EXERCISES. FREEHAND SKETCHING. Sketch, on the space provided, the first angle projection of the component below.

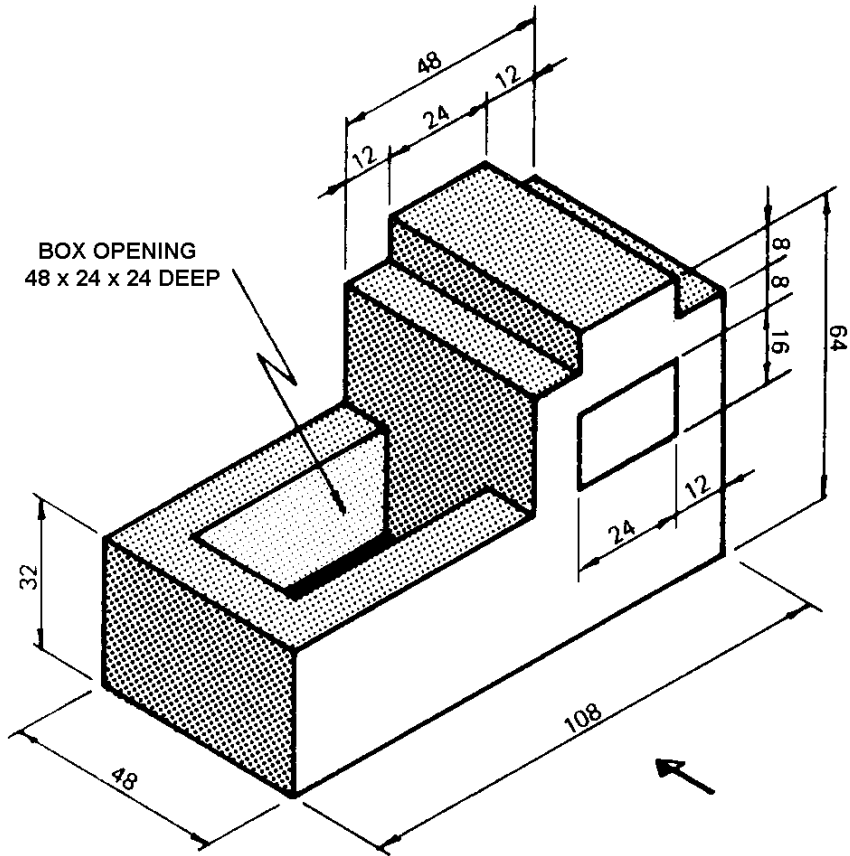

DRG.

ORTHOGRAPHIC PROJECTION

EXERCISE 13

Exercises. Draw three views of the following components, either in first or third angle projection. Show hidden detail where necessary and fully dimension your drawing.

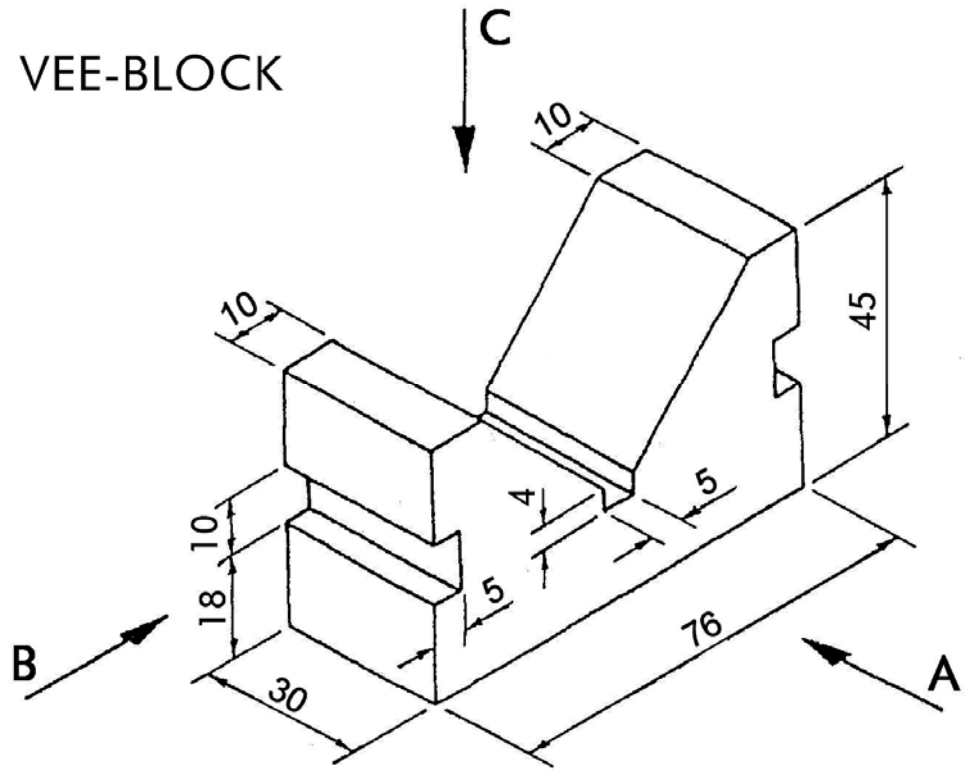
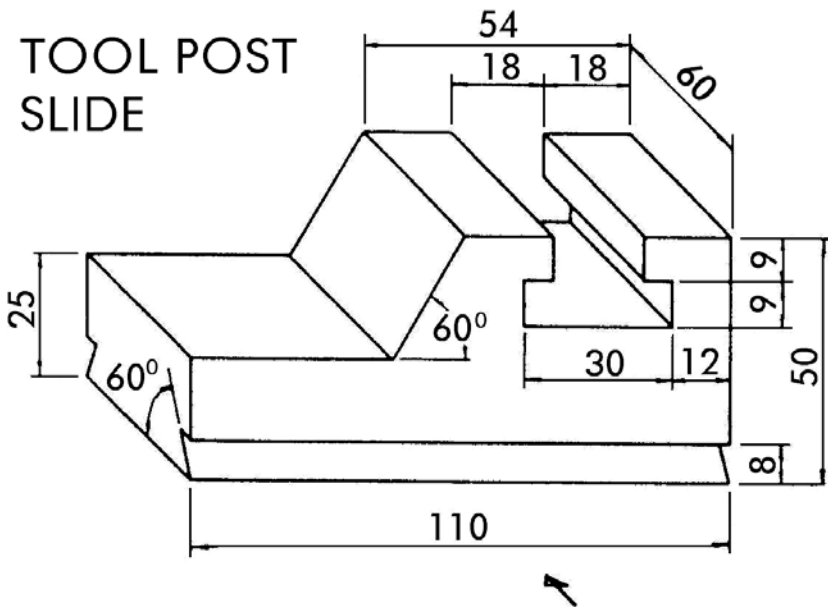

DRG.

ORTHOGRAPHIC PROJECTION

ALL DIMENSION IN MILLIMETRES

Exercises. Draw three views of the following components, either in first or third angle projection. Show hidden detail where necessary and fully dimension your drawing

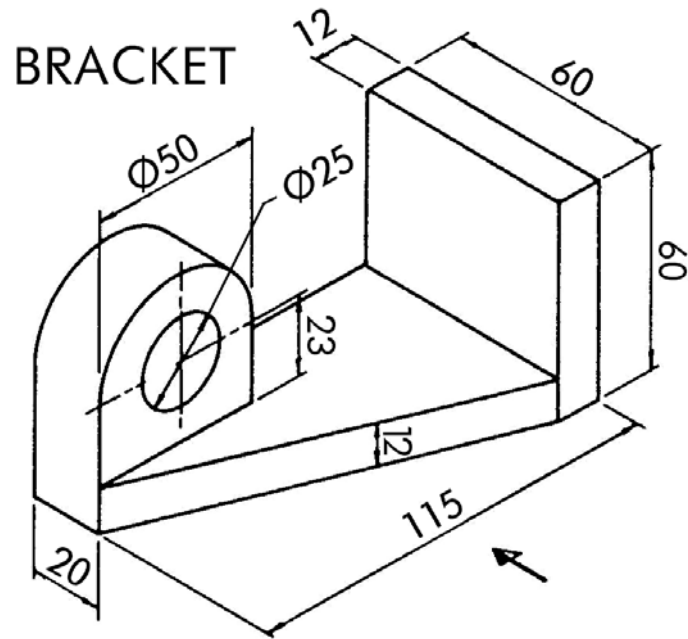

LOCATING GUIDE

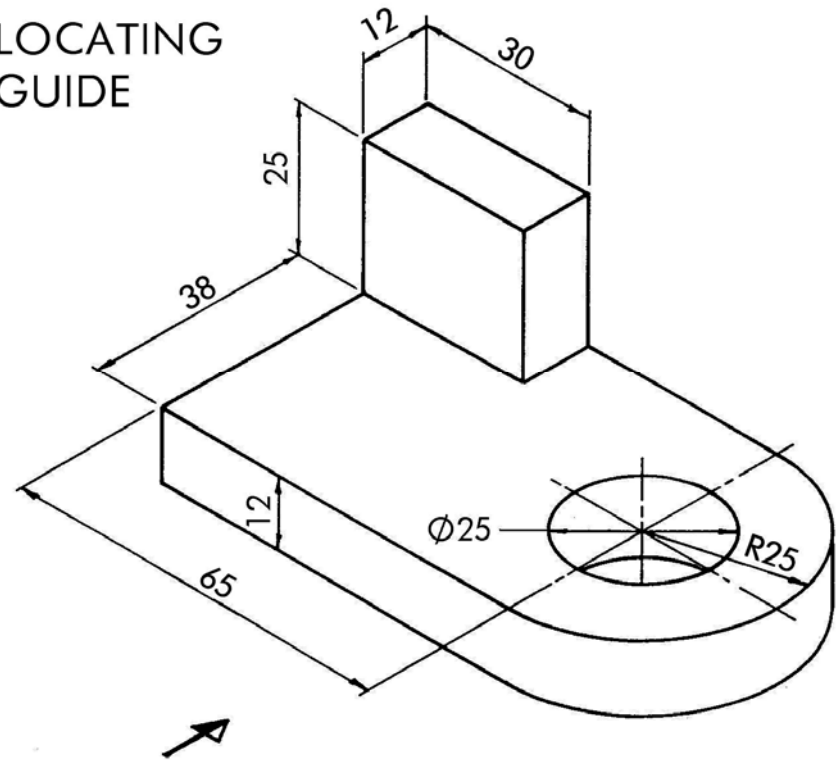

DRG.

ORTHOGRAPHIC PROJECTION

ALL DIMENSION IN MILLIMETRES

Exercises. Draw three views of the following components, either in first or third angle projection. Show hidden detail where necessary and fully dimension your drawing

SUPPORT BRACKET

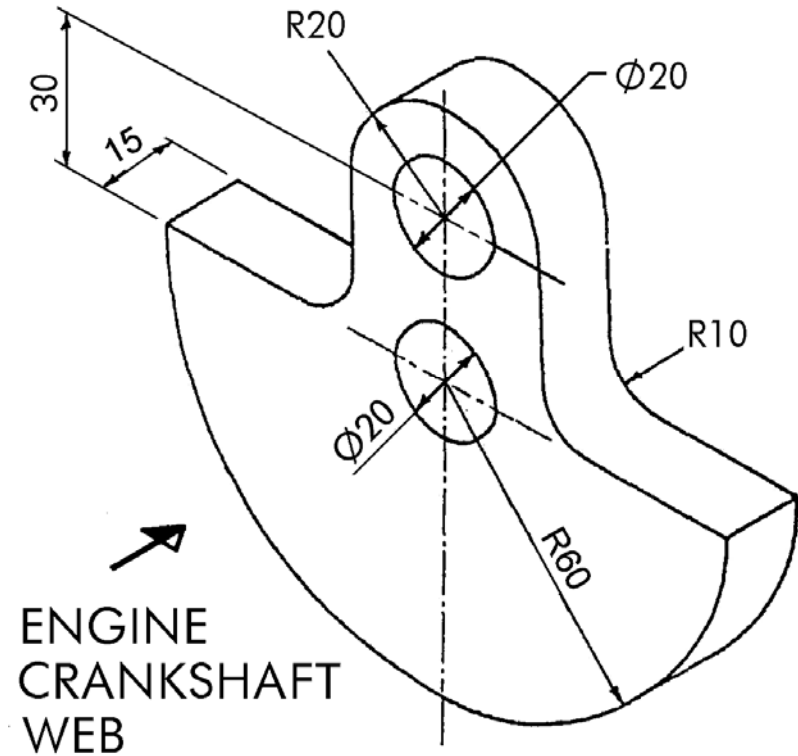
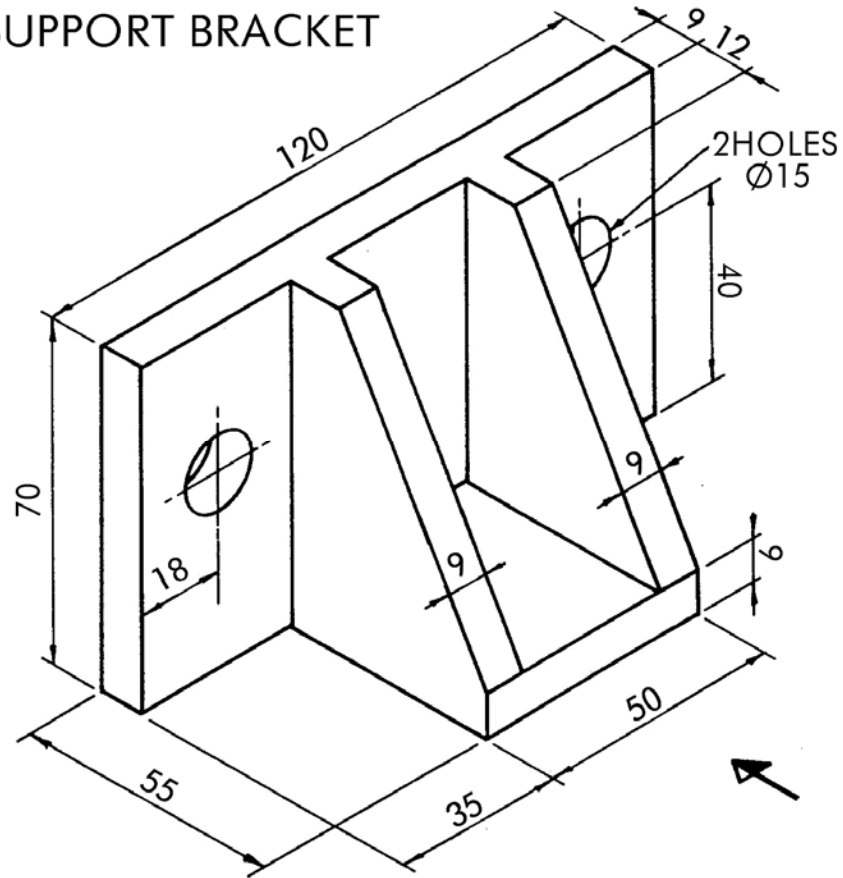

ENGINE CRANKSHAFT WEB

DRG.

ORTHOGRAPHIC PROJECTION

ALL DIMENSION IN MILLIMETRES

Exercises. Draw three views of the following components, either in first or third angle projection. Show hidden detail where necessary and fully dimension your drawing.

UNIVERSAL COUPLING

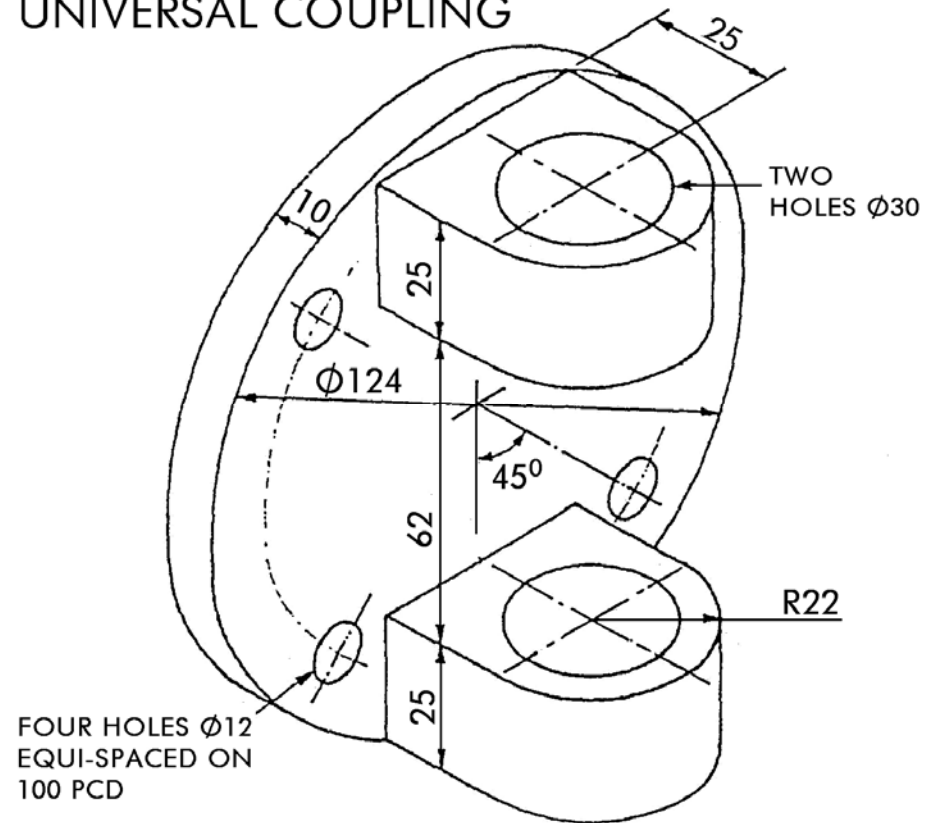

DRG.

ORTHOGRAPHIC PROJECTION

ALL DIMENSION IN MILLIMETRES

