

Nat 3 Ex 7

(Out of 21)

1) The diagram shows a cube with sides of 5cm. Calculate the volume. (3)

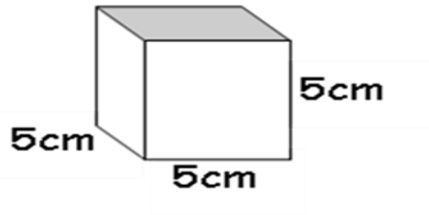

2) Find the area of the following shape (1)

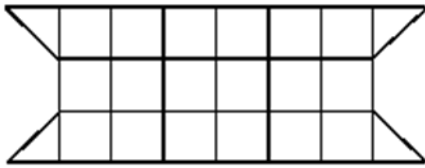

3) Calculate the area of the triangle (3)

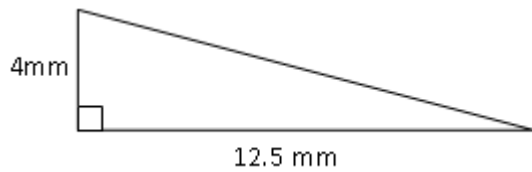

4) Shown is a rectangular picture frame.

Calculate a) the perimeter (2)

b) the area (3)

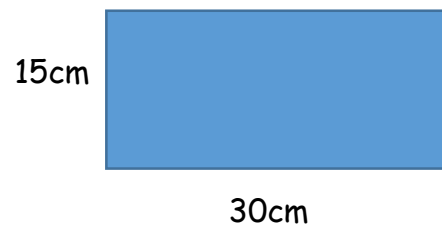

- 5) Find the volume of this shape each cube represents 1 cubic cm (2)

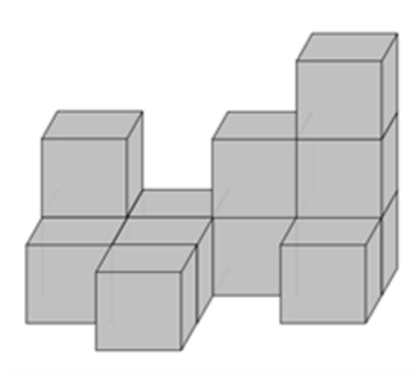

- 6) This is a sketch map of a school playground. Calculate the perimeter (2)

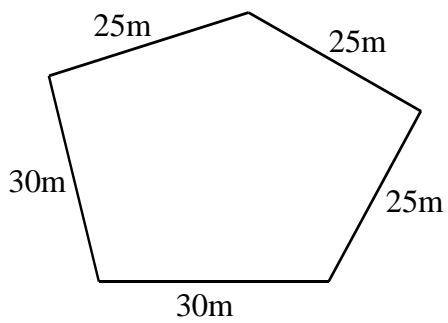

- 7) Calculate the area of this shape (5)

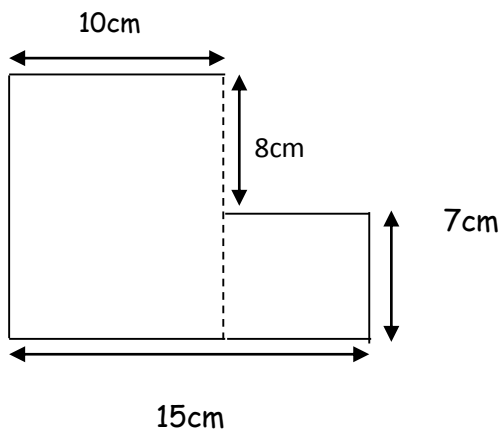

Perimeter, Area & Volume of a cuboid