



Graphic Communication

Standards and conventions: information and support for candidates

Please note that this document may not be taken into an external examination, nor is it permitted to be displayed in any room where an examination is taking place.

This edition: August 2016, version 2.0

Published by the Scottish Qualifications Authority
The Optima Building, 58 Robertson Street, Glasgow G2 8DQ
Lowden, 24 Wester Shawfair, Dalkeith, Midlothian EH22 1FD

www.sqa.org.uk

The information in this publication may be reproduced in support of SQA qualifications. If it is reproduced, SQA should be clearly acknowledged as the source. If it is to be used for any other purpose, then written permission must be obtained from **permissions@sqa.org.uk**. It must not be reproduced for trade or commercial purposes.

© Scottish Qualifications Authority 2016

Introduction





This support document provides information on the expected use of Standards and Conventions for all SQA Graphic Communication Courses. It is not intended to be an exhaustive list of those used in the graphic industry, nor does it cover every single term in the associated Course Assessment Specifications. It should be considered as guidance and should be read in conjunction with the relevant Course, Unit and Assessment Specifications.





Building drawing symbols



These symbols are drawn from BSI.

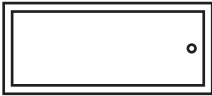

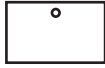
You may be required to use these symbols in your assignment or project, or be asked questions about them in your exam.



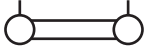

You **must** use the symbols and terms specified below.



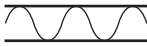
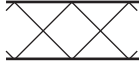

Lamp	Switch	Socket	Radiator
			



Shower tray	Bath	Wash basin	Sink	WC
				

Sinktop	Heated towel rail	Concrete	Brickwork
			

Door	Sawn timber	Insulation board	Blockwork
			



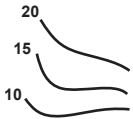

Fixed window	Window-hinged at side	Window-hinged at top	Window-hinged at bottom
			

Window-pivoted, horizontal axis	Window-sliding horizontally	Drainage	North sign
			

Existing tree	Existing tree-to be removed	Proposed tree	Contours
			

Technical graphic line types

These are the technical graphic line types that you should use in your work.

Outline solid	Projection line	Hidden detail line	Centre line
 <p>Continuous thick line for visible edges and outlines.</p>	 <p>Continuous thin line for projecting between views.</p>	 <p>Dashed thin line for hidden detail.</p>	 <p>Long dash, dot, chain line for centres of symmetry.</p> <p>Please note that BS (7)308 (long dash, short dash chain) is also acceptable.</p>

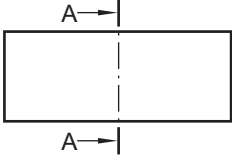
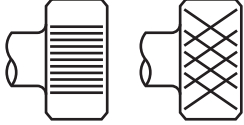
Fold line	Cutting plane	Knurling
 <p>Thin long dash, double dot, chain line to indicate folds on surface developments.</p> <p>BS (7)308 (long dash, short double dash chain) is also acceptable)</p>	 <p>Long dashed dotted thin line, thick at ends. Please note that BS (7)308 (long dash, short dash (chain) line thick at ends) is also acceptable.</p>	

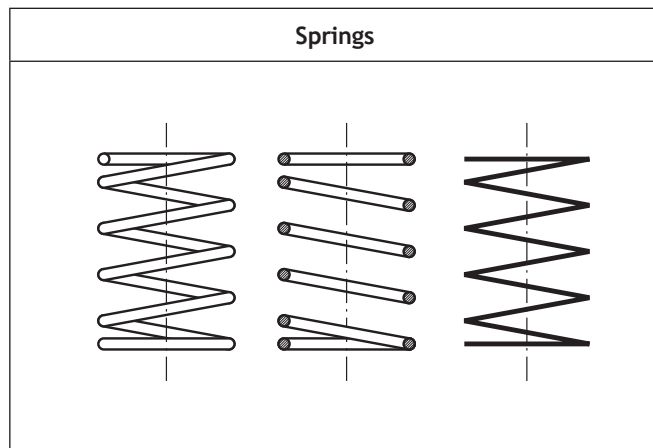

Dimensioning terms

These are the conventions for technical graphic dimensioning that you should use in your work.

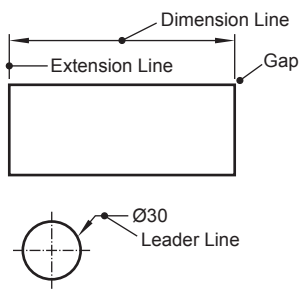
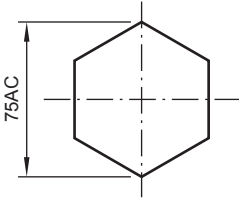
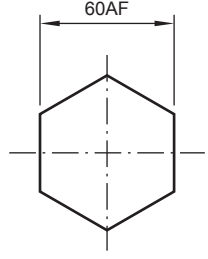
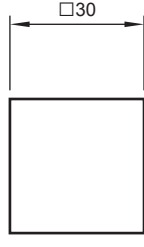
Leader line	Across corners	Across flats	Square
			

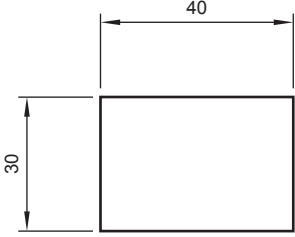
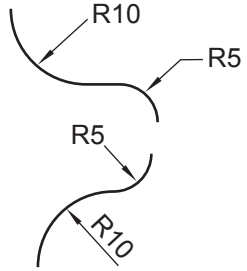
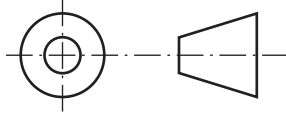
Linear	Radial	Projection symbol
		 <p>3rd angle projection</p>

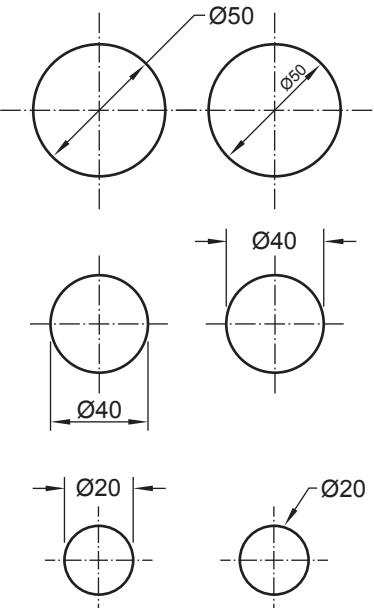
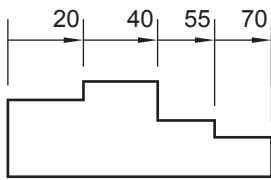
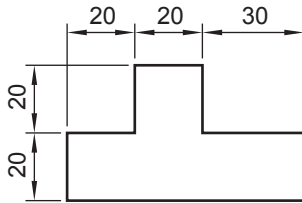
Diameter	Running	Chain
		

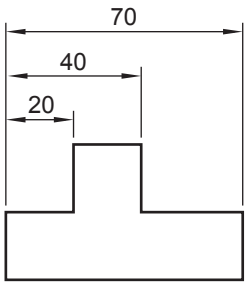
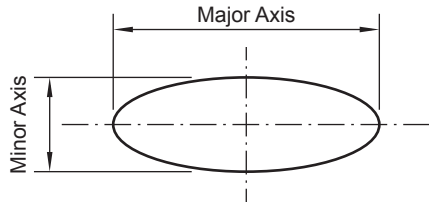
Parallel	Major and minor axis
	

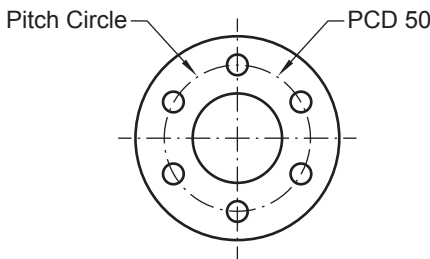
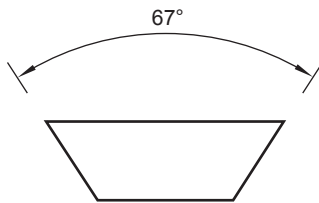
Pitch circle diameter	Angular dimension
	

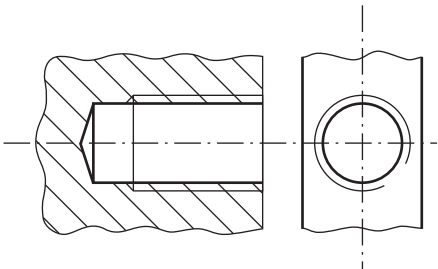
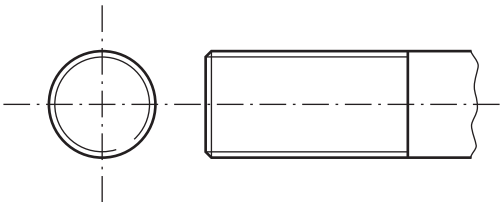
Internal screw threads	External screw threads
	

Tolerances

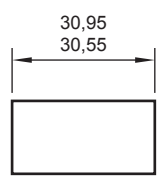
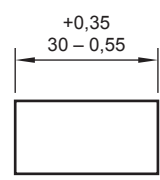
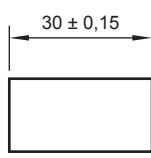
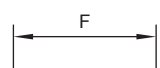
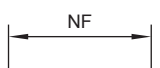
Common tolerance	Asymmetrical tolerance	Symmetrical tolerance	Functional tolerance	Non-functional tolerance
				
The Common method shows the upper limit of the size placed above the lower limit.	The Asymmetrical method shows the nominal size plus the upper and lower limits of the tolerance.	The Symmetrical method shows the nominal size and the symmetrical tolerance expressed as a plus and minus.	A dimension that is essential to the function of a component or space.	A dimension that is not essential to the function of a component or space.

3D CAD terms

3D CAD is an important aspect of Graphic Communication and you will be expected to demonstrate skill in using it throughout the Courses.

You will be required to answer questions about 3D CAD in your exam. You may be using terms pertaining to a specific software platform, however, you should know these generic terms for 3D CAD.

These terms can be found in the Course Assessment Specifications for the Graphic Communication Courses. Candidates and centres should note that these are **not the only** terms to be covered at these levels.

At National 4 and 5

Extrude	Revolve	Subtract	Assembly
The term used when a 2D profile is pulled into a 3D shape. The term add or subtract must be used to describe the function of the extrude.	A profile that is rotated around an axis.	Used in conjunction with features to describe material being removed from a 3D model.	Multiple components combined to create a model.

Fillet	Chamfer	Shell	Materials
A rounded edge applied to a corner. Can be applied in either the sketch or as a stand-alone feature.	A straight edge applied to a corner. Can be applied in either the sketch or as a stand-alone feature.	Used to remove material from the inside of a 3D model to a specified wall thickness. It can also be used to remove a face.	Apply a material to a CAD model. This can be used for illustration or to conduct a CAD simulation or test.

Align	Centre axis	Component	Mate
To align the face of a 3D model with another face.	To align cylindrical objects, circular edges or circular faces.	A single component part, used to create an assembly later on.	To join the face of a 3D model to another face.

CAD library	Sketch
A directory of commonly used parts.	The name given to the CAD drawing feature used to create a profile.

At Higher, in addition to those at National 4 and 5

Orientate	Offset	Offset – (2D CAD)
Constrains faces, straight edges, or workplanes at an angle.	Mates or aligns two faces or workplanes by making their planes parallel and constraining the separation distance between the planes.	Is used to create parallel copies of sketch objects, lines, or curves at a specified distance from the original.

Constraint	Add	Profile
Dimension tool used to lock 2D geometry to a particular shape, size or position.	Used in conjunction with features to describe an addition to the 3D model.	The name given to a 2D shape, prior to being used to make a 3D feature.

Radial Array	Workplane	Array	Projected edge
An item repeated in a circle with regular spacing.	A surface where sketches can be applied. Most CAD packages will provide three (elevation, end elevation and plan), but more can be added by the user.	A method of repeating a shape along a line, in a box or round a circle.	To select an edge from a CAD model or feature and generate it as a new line in a sketch.

Fixed	Vertices	Edge	Faces
To hold a 3D CAD model in a fixed point, without applying any constraints. Usually applied to the first component in an assembly.	The “corners” or where edges meet on a 3D object.	The edges of a 3D object.	The face of a 3D object.

Loft	Irregular fillet	Linear array	Box array
A command where two or more profiles on workplanes that are spaced apart, are joined to create a 3D feature.	A rounding of an edge, where the radius will change.	An item repeated along an edge, with regular spacing.	An item repeated in a square or rectangle, with regular spacing.

Irregular chamfer	Helix	Extrude along a path	Intersect
The removal of an edge by a cut, where the distance changes along the length of the edge.	A profile that revolves around an axis, but has an offset or pitch’ distance. Often used to model threads, screws or springs.	A profile that has been extruded by following a set route or ‘path’.	Two 3D CAD features that pass through one another, with the result that only the area that the two touch remains. Everything else is deleted.

At Higher, in addition to those at National 4 and 5 (continued)

Light source	Reflection	Bottom up modelling	Top down modelling
The source of light to illuminate a 3D CAD model and scene.	A reflection in material, colour or light on the 3D CAD model or in the scene.	Bottom up modelling is when parts are modelled then inserted and fixed in relation to other components in an assembly using mates.	Top down design is an option to create new parts within assembly. Constraints are the existing geometry elements from other parts within assembly: lines, planes, surfaces, points, vertices.

Axis	Datum	Sub-assembly	Suppress
An axis represents a line travelling in a direction. Typically these are X, Y and Z but can be combinations.	A key point in which dimensions, sizes and other details are taken from.	An assembly of components that is added to another, larger assembly.	To turn a feature or command off within the modelling tree.

Solid model	Wire frame	Modelling tree	Sited environment
An object that can be viewed from any angle, geometry created within 3D space.	A method of presenting a 3D CAD model, showing only the edges. Faces are transparent.	The linear hierarchy of how a 3D CAD model is created or assembled.	An environment that represents how the 3D CAD model would look in a realistic environment.

STEP/IGES
STEP and IGES files are a method of sharing 3D CAD components and assemblies between CAD platforms. Widely used for stock or library components.

At Advanced Higher, in addition to those at National 4, 5 and Higher

Texture mapping	Bump mapping	Specularity	IBL
Applying a texture to the surface of a 3D CAD model, to represent a real material. Often used in conjunction with bump mapping.	A method of suggesting that materials have a rough or tactile surface, whilst not increasing the polygon count.	The reflective capacity of material to create 'rings' of light reflection.	Image Based Lighting simulates how light and shadow from a real environment would interact with a 3D CAD model.

HDRI	Volumetrics	VRML	3DS
High Dynamic Range Imagery creates multiple exposures of an image and combines them to enhance colour and shadow.	A method of giving a light source a sense of volume or substance. For example, light streaming through a stained glass window.	Virtual Reality Modelling Language — a method of passing 3D CAD data to programmes for testing or simulation.	A file type containing 3D data, widely used in 3D animations or illustrations.

CFD	FEA
Computational Fluid Dynamics — a method of testing how well a 3D CAD model would pass through a liquid or gas (or how the liquid or gas would pass the 3D CAD model).	Finite Element Analysis is a method of testing the strength and mechanical properties of a 3D CAD model.

Printing and production terms (Advanced Higher)

3D printing	CMYK	RGB	DPI
3D printing a method of converting 3D CAD data into a physical object, by 'adding' material, rather than cutting.	Cyan, Magenta, Yellow and Key (the key colour is usually black) are used in commercial printing systems, as they allow a greater range of colours and appear more natural.	Red, Green, Blue is used in electronic displays and works by mixing the three colours to generate secondary and tertiary colours.	Dots-Per-Inch is a method of describing the resolution for printing. The higher the number, the sharper and better quality the image is.

PPI	Overprint	Addictive colour	Subtractive colour
Pixels-Per-Inch is a method of describing the resolution of a screen. The higher the number, the sharper and better quality the images can be on a screen.	Printing beyond the required region to ensure the layout will appear edge-to-edge printed after being cut.	When colours are added together through an electronic display, the result will be white, due to the light emitting rather than being reflected by the sun/room light.	When colours are added together through a print, the result will be black, due to the light being absorbed rather than reflecting.

Screen printing	WMV/AVI/Quicktime	Motion-capture	Stop frame
A cost-effective method of creating large prints of moderate volume. Typically used for advertising banners or T-shirts.	WMV, AVI and Quicktime are all movie formats.	A method capturing physical data about the movement of a person, animal or object and applying it to a 3D CAD model.	A method of animation, relying on shooting individual frames of a graphic and combining them. Typically 25 frames are required for 1 second of animation.

Motion tweening	STL	CAM	Tool path generation
A method of animating 2D or 3D CAD, by specifying the start and end positions of a graphic, and allowing the computer to plot the animation.	Standard Tessellation Language — 3D file format used to manufacture 3D CAD models in 3D printers or other CAM equipment.	Computer Aided Manufacture is technology used to take 2D or 3D CAD data and machine the shapes or forms from a material.	Software used to plan the movement of cutting or shaping tools in CAM systems.

Published: August 2016

Change since last published:

Minor corrections to fix errors