

A (1 : 1)

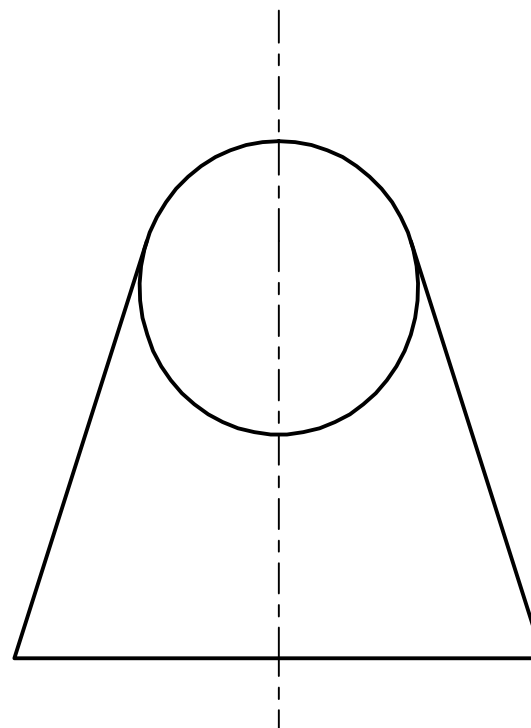

TRUE SHAPE	N4/5 GC
CUT CONE	
ROSSHALL ACADEMY TECHNICAL DEPT.	

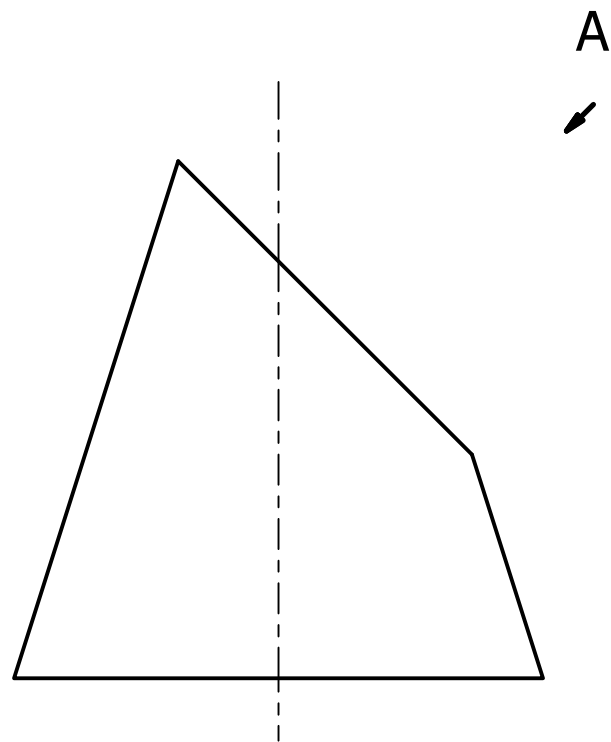
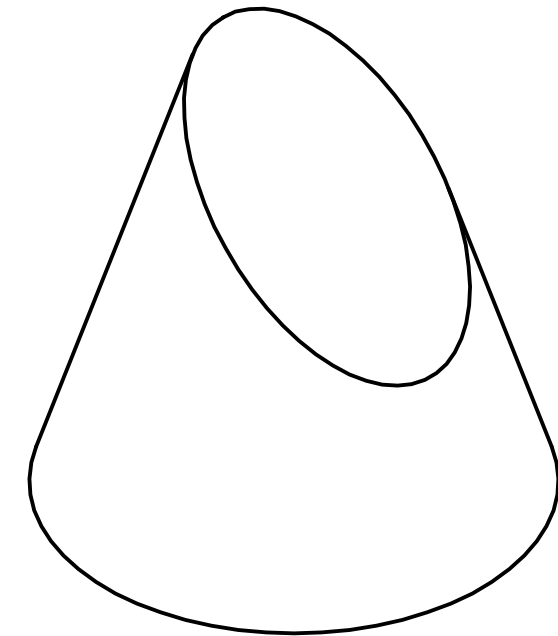
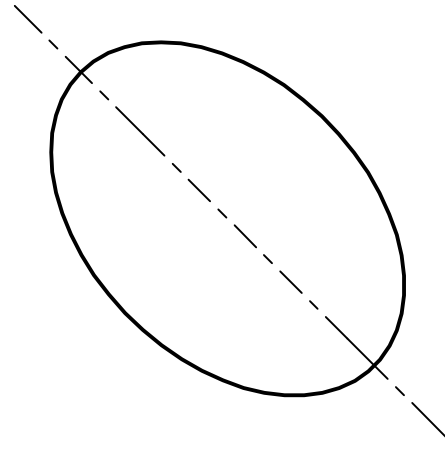
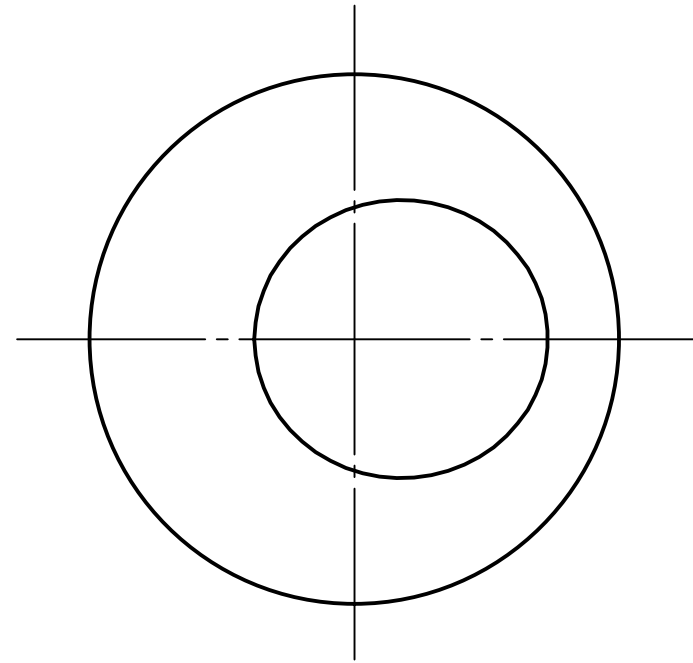
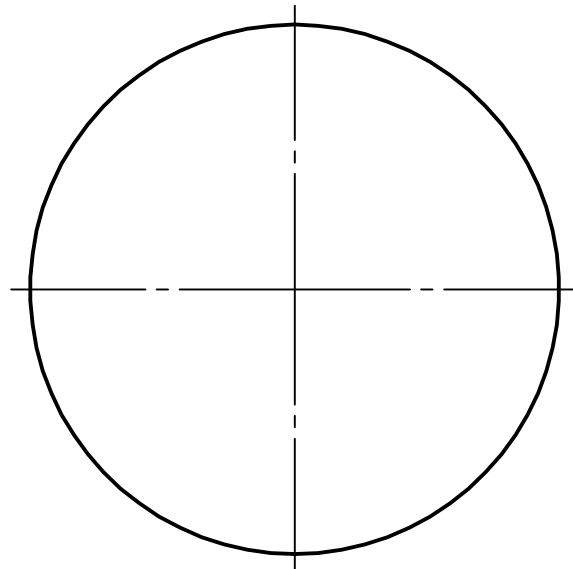

PLAN

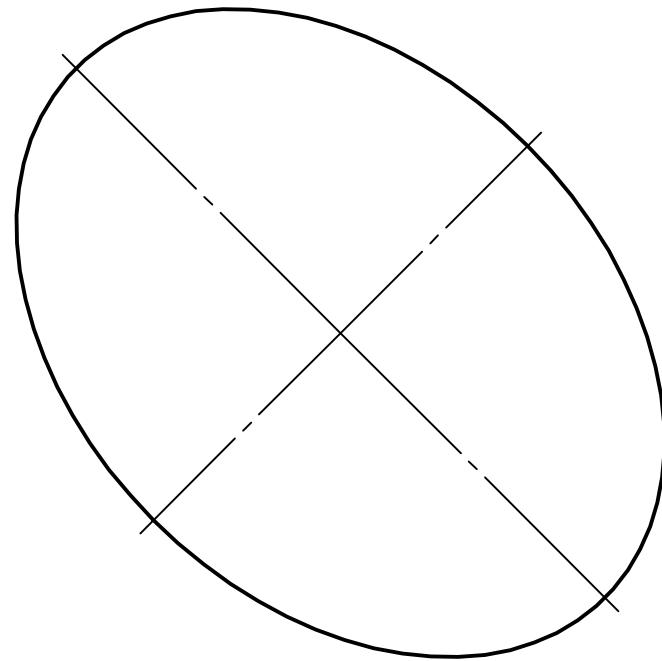

TRUE SHAPE

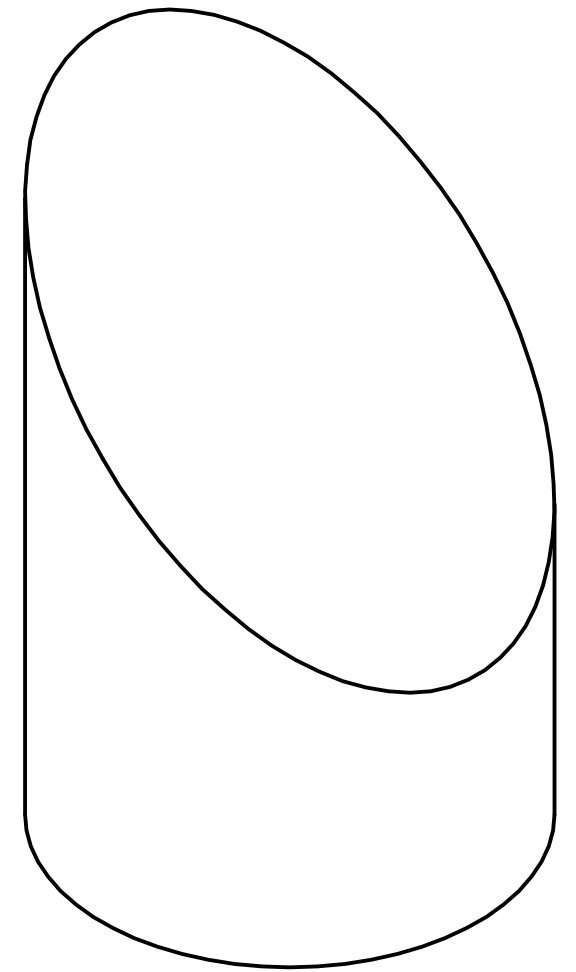

ISOMETRIC VIEW

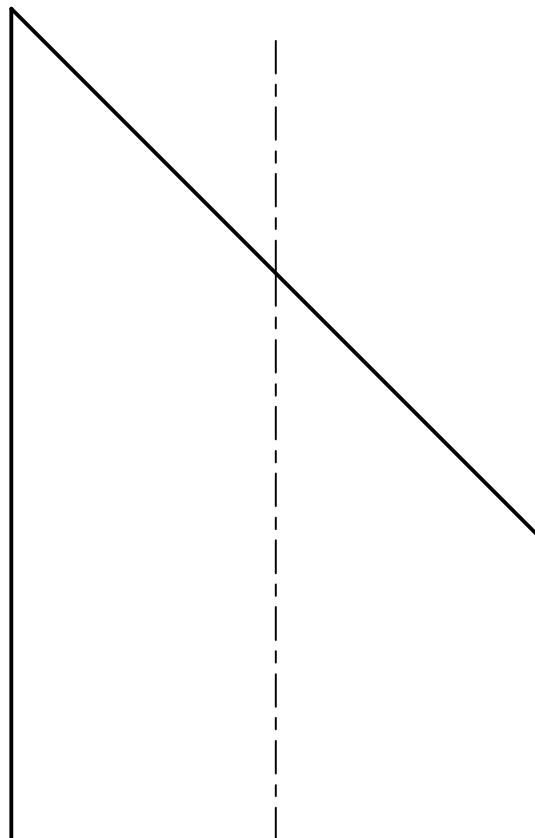

ELEVATION

E
↙

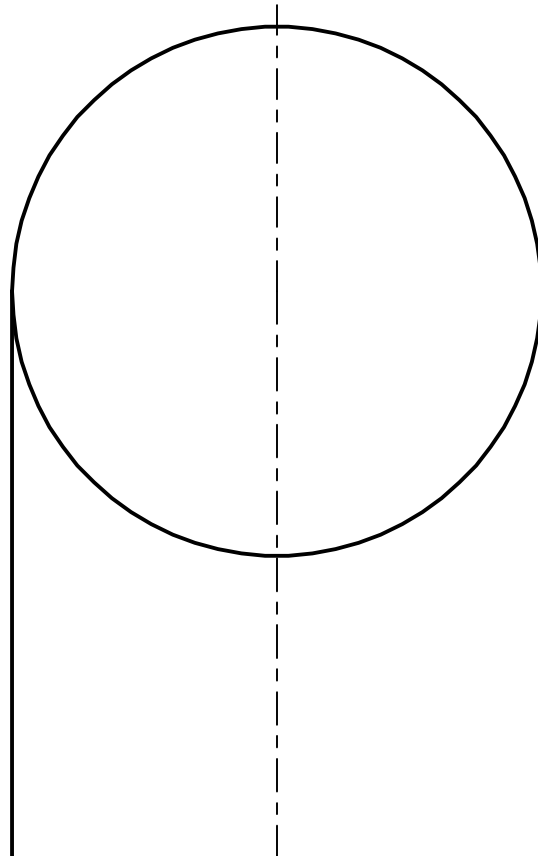

END ELEVATION

TRUE SHAPE	N4/5 GC
CUT CYLINDER	
ROSSHALL ACADEMY TECHNICAL DEPT.	

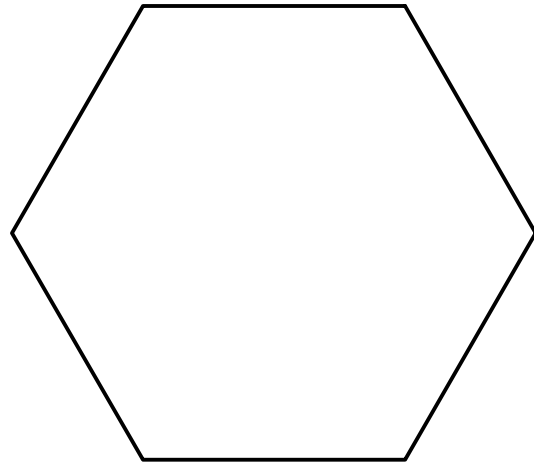

PLAN

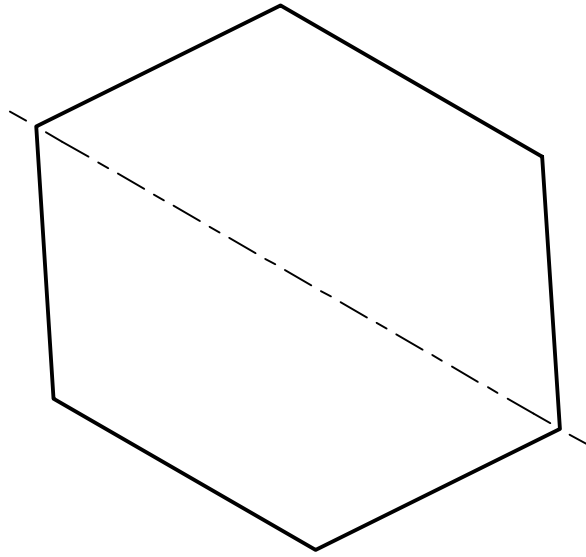

TRUE SHAPE

F
↙

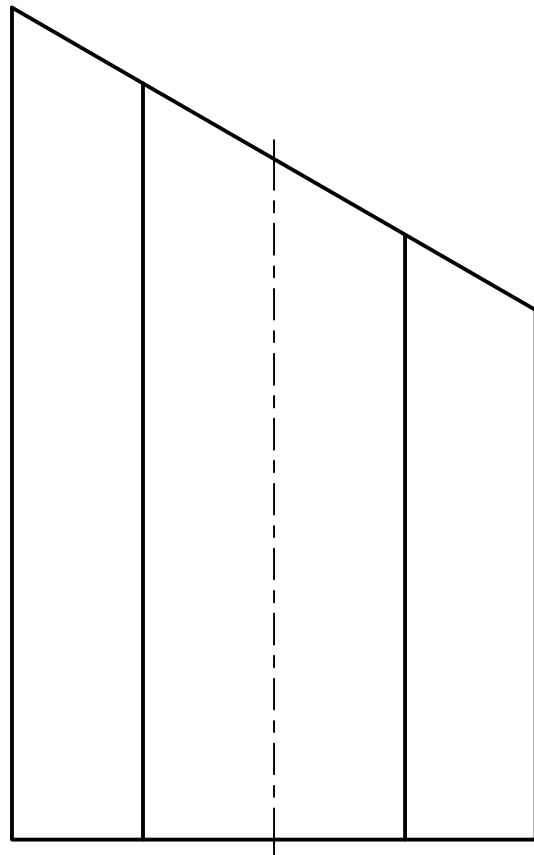

ELEVATION

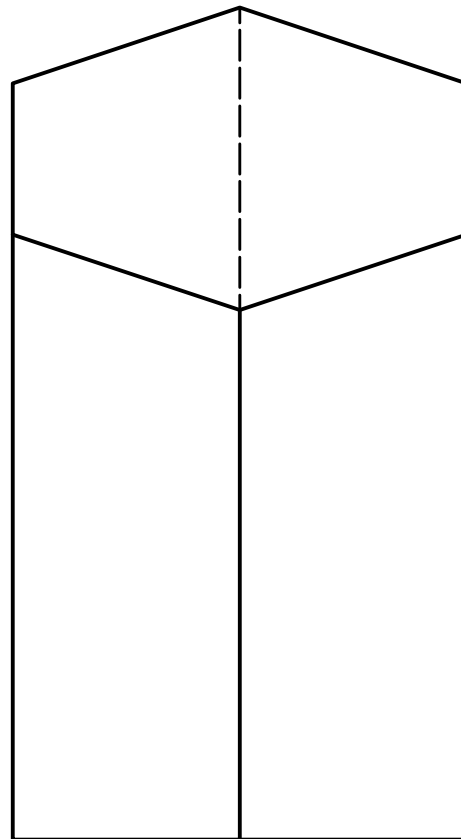

END ELEVATION

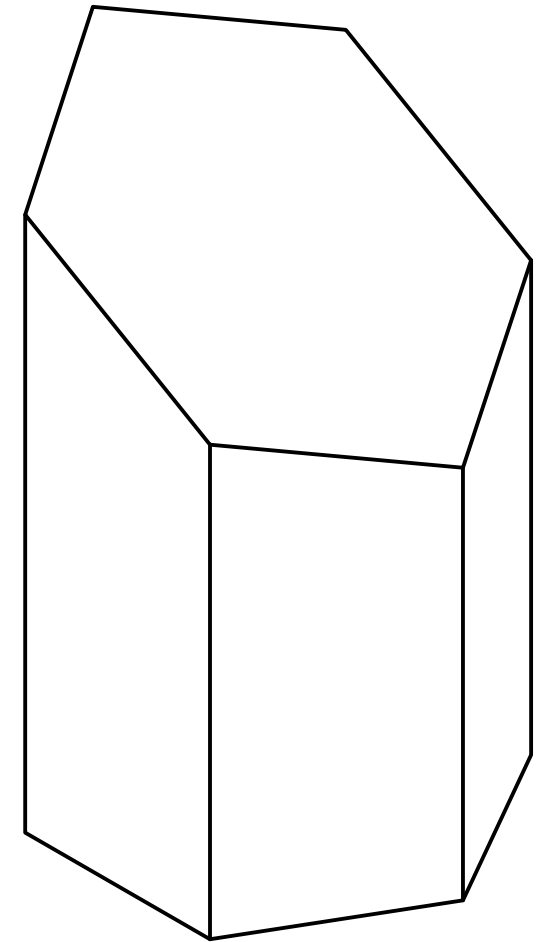

ISOMETRIC

TRUE SHAPE	N4/5 GC
CUT HEXAGON	
ROSSHALL ACADEMY TECHNICAL DEPT.	

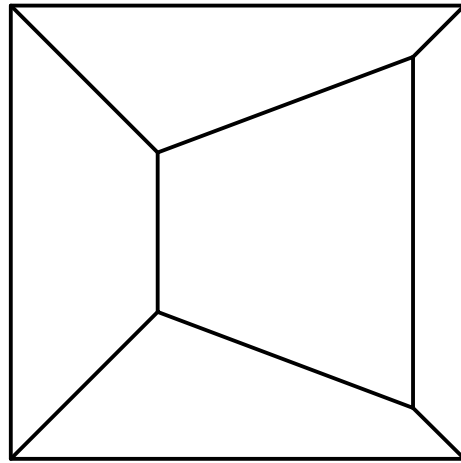

PLAN

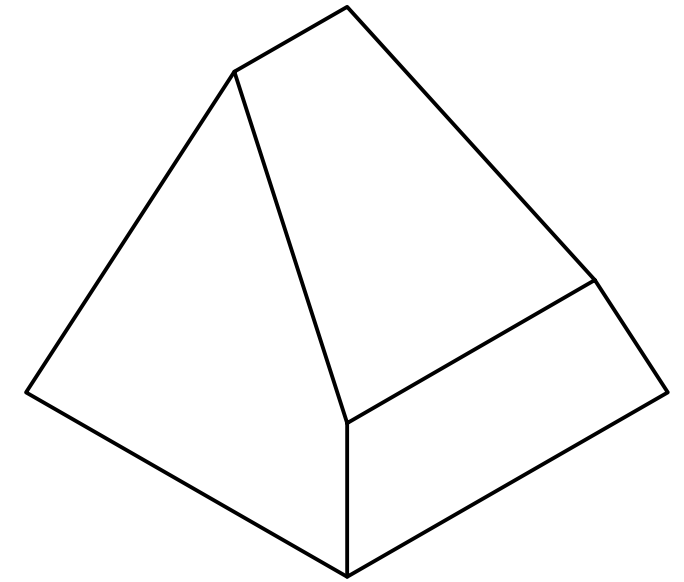
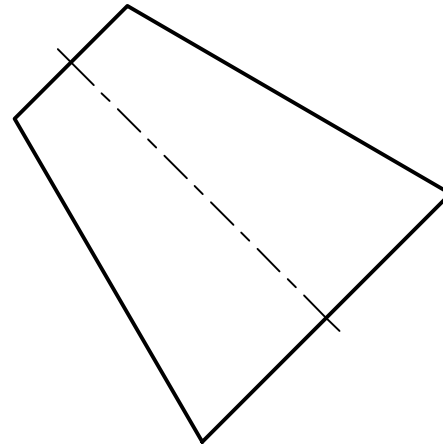

ISOMETRIC

B
↙

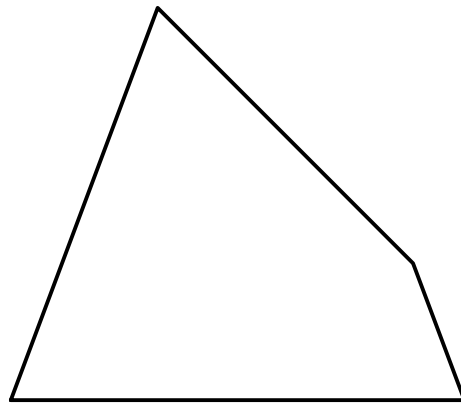

ELEVATION

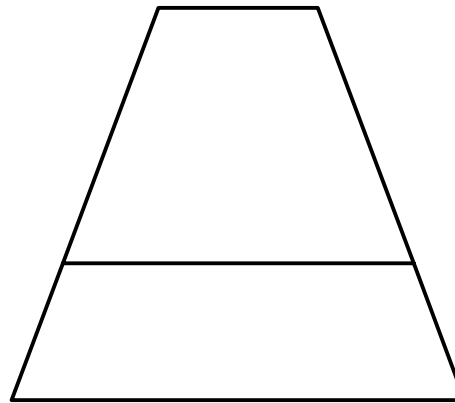

END ELEVATION

TRUE SHAPE	N4/5 GC
CUT PYRAMID	
ROSSHALL ACADEMY TECHNICAL DEPT.	

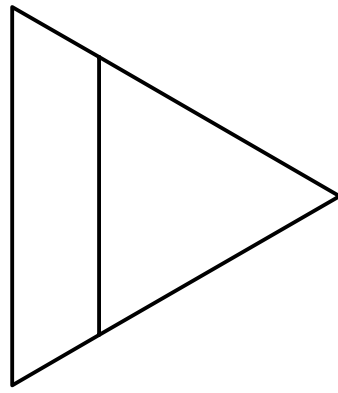

PLAN

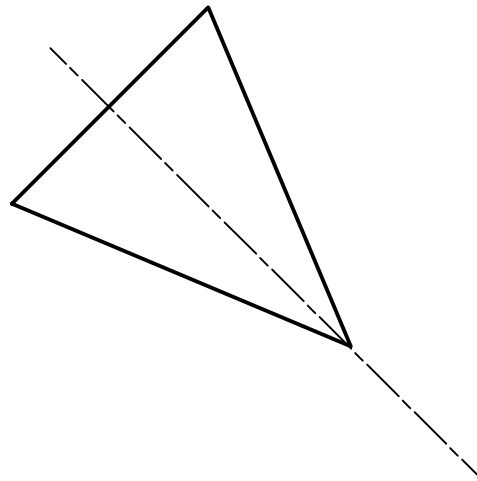

G

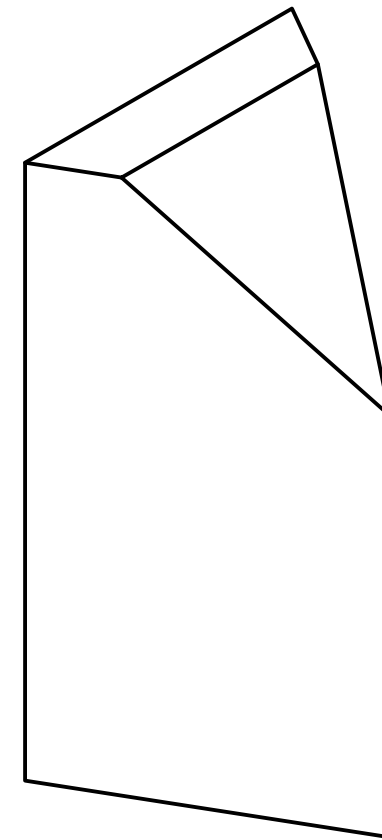

ISOMETRIC

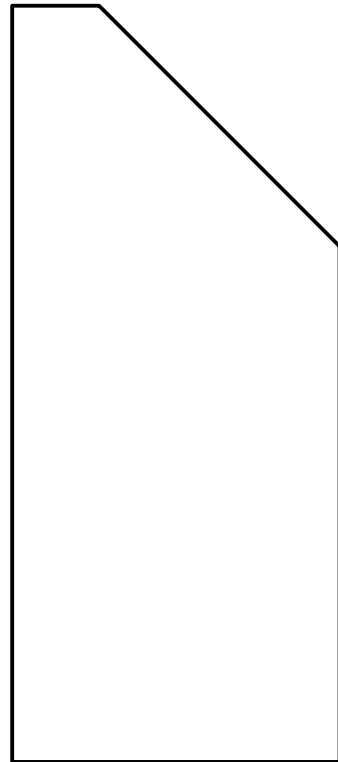

ELEVATION

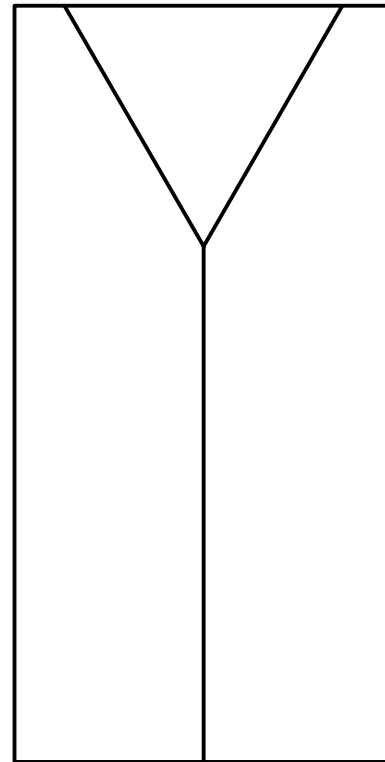

END ELEVATION

TRUE SHAPE	N4/5 GC
CUT TRIANGULAR PRISM	
ROSSHALL ACADEMY TECHNICAL DEPT.	

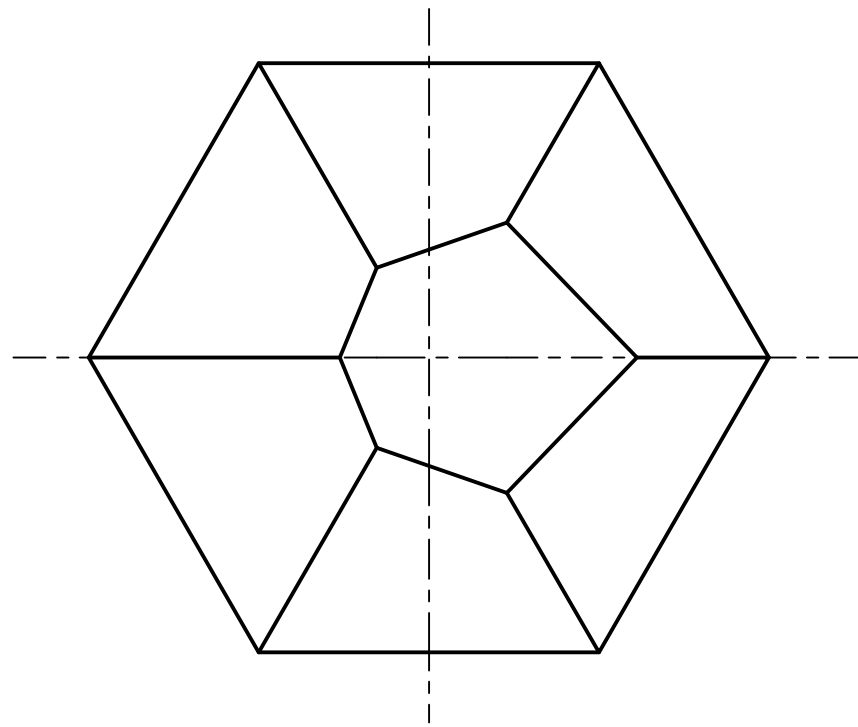

PLAN

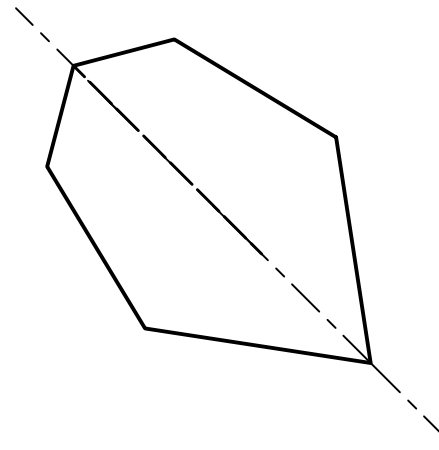

TRUE SHAPE

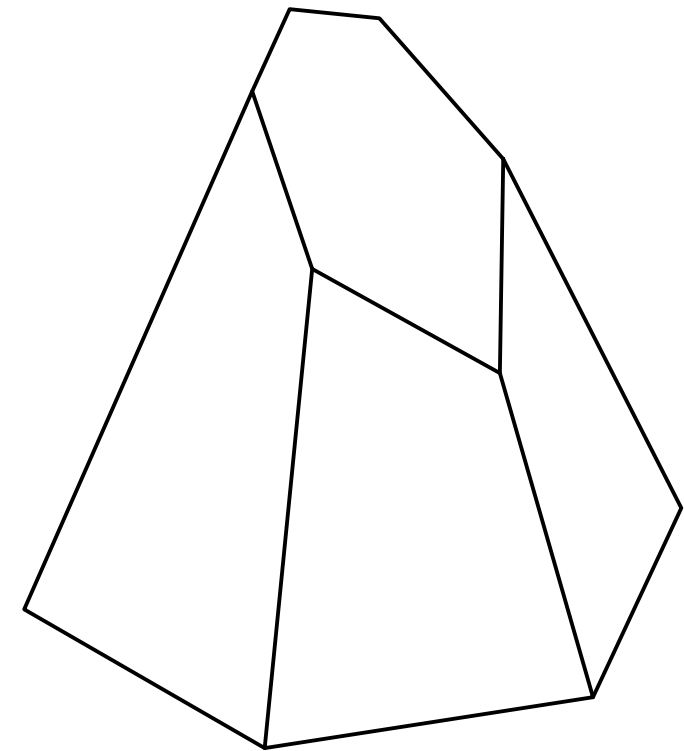

ISOMETRIC

D

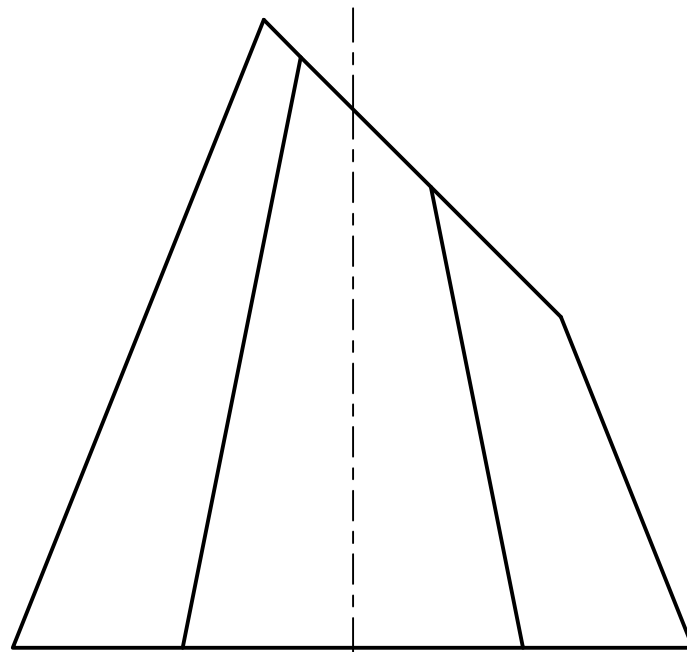

ELEVATION

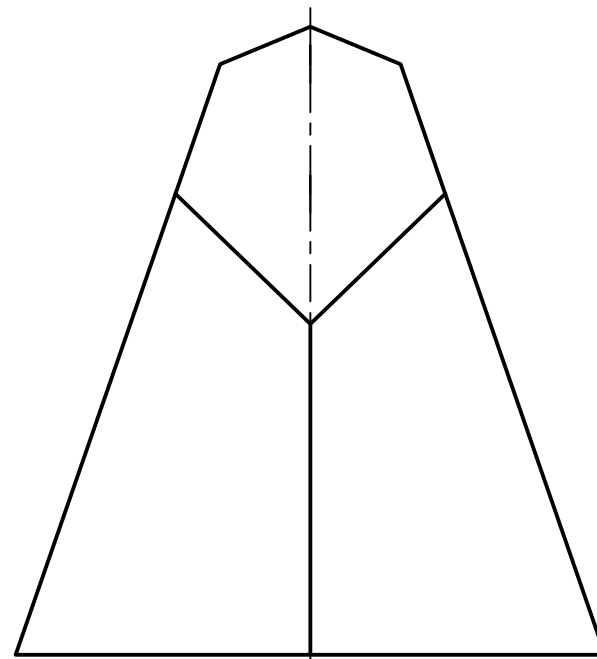

END ELEVATION

TRUE SHAPE	N4/5 GC
CUT HEXAGONAL PYRAMID	
ROSSHALL ACADEMY TECHNICAL DEPT.	