

St Ninian's High School

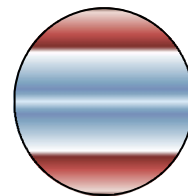

Maths Newsletter

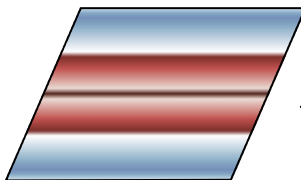
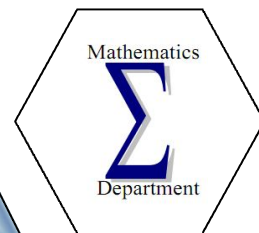
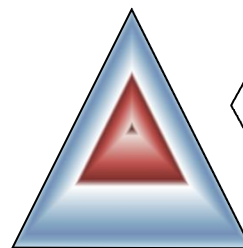

April 2013

Volume 2: Issue 3

Inside this issue:

Mrs Thatcher and Mr Whippy	2
Farewell Mrs Nizam	2
Prime Time News	2
UK Maths Challenge	3
Puzzle of the month	3
Mindbending matches	4
Exam countdown	4

Mrs. Thatcher and Mr. Whippy

A little known fact about the late Baroness Margaret Thatcher was that she was one of the scientists who worked on developing Mr Whippy ice cream. Margaret Thatcher



studied Chemistry at Oxford before becoming a barrister. In 1959 a research group called Forte, which Margaret Thatcher was in, discovered a way of doubling the amount of air in Ice Cream. This allowed manufacturers to use less of the actual ingredients, thereby reducing costs. They experimented by inject-

ing air into ice-cream until it collapsed and put vegetable oil instead of the animal fat normally in the dairy cream.

By Mark Rae.



After School Classes

Monday-
Higher and Adv. Higher
Mathematics

Tuesday-
Intermediate 2
Mathematics

Thursday-
S1-S3 Mathematics
Higher Mathematics

Facts on Facebook

1 in every 13 people on the planet is on Facebook

50% of active users log on to Facebook everyday.

In 20 minutes 2,716,000 photos are uploaded

The Average user has 130 friends. (I bet you don't know half of them!)

48% of 18 to 34 year olds check Facebook right when they wake up.

Facebook is valued at \$80 Billion! You may be wondering how Facebook makes money if it is "Free and

always will be". Well, Facebook makes money by advertisers on the site and also by people purchasing "Facebook coins" to buy stuff, in games on Facebook, and a lot of people do that so that is what makes Facebook worth so much.

By Mark Rae.

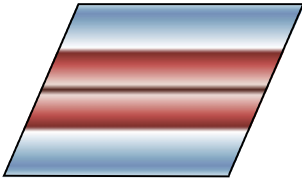

Prime time news!

GIMPS (The Great Internet Mersenne Prime Search) has done it again! They've found the biggest prime number to date.

$2^{57,885,161} - 1$. This massive 17,425,170 digit number discovered by mathematician Curtis

Cooper has got a \$3000 reward. Interested in joining the search? Look up GIMPS and sign up. Your computer does all the work!

By Joe Dias 1a7
Mark Rae 1a1.

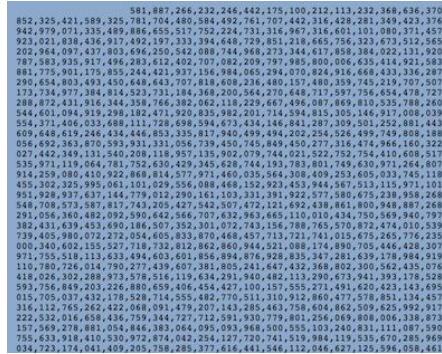

Just a few of the 17,425,170 !!

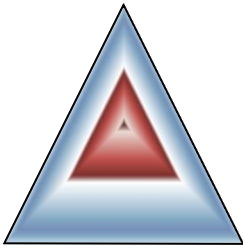

Farewell, Mrs Nizam!



Alas, Mrs Nizam, Teacher of Maths here at St. Nini-ans and founder of the Maths Newsletter, will be leaving this

Friday, for a well deserved rest! We wish her all the best in her life and thank her for all the great contribu-

tions she gave to the Maths Department, over her 3 years here. We'll all miss you!

Rocking the world- Some of the worlds largest shakes and quakes!!

SHAKY

Valdivia Earthquake, this magnitude 9.5 earthquake is the biggest on record. It had the equivalent force of 2976240539.484 tons of dynamite blowing up. Wow!

SHAKIER

Chicxulub Impact, This was the meteorite that hit the earth 65 million years ago and wiped out all the dinosuars. It was estimated at a magnitude of 12.55.

SHAKIEST OF THEM ALL!

Magnetar SGR 1806-20, This earthquake happened in 2004 on a star 50,000 light years away. It had a magnitude of 32!! So strong, we felt its effects on earth!

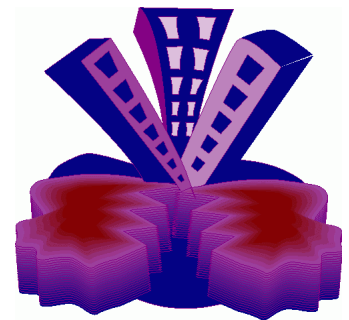

Source- How it Works Magazine Issue 39.

Mark Rae 1a1

Celebrating Achievement!

Volume 2: Issue 3

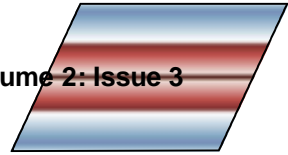

SCOTTISH MATHS **CHALLENGE WINNERS!**

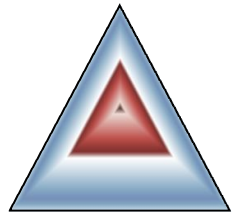

S2 WINNER

GEMMA McDONALD (SILVER)

S1 WINNERS - BRONZE

CARA McBRIDE

LUCY HOLMES

ANNA GALLAGHER

CAITLYN MARTIN

Well done to everyone!



Don't forget to keep up to date with the school website and Glow!

See your teacher if there are problems with your password!



St Ninian's High School

Week Ahead | About Us | Information | Departments | Pupils | Parents | Contact Us

Search

Mathematics and Numeracy Website

Latest News | About Us | Celebrating Success | Timelines | Severe Weather Contingency

In this diagram 11 matches make 3 squares:

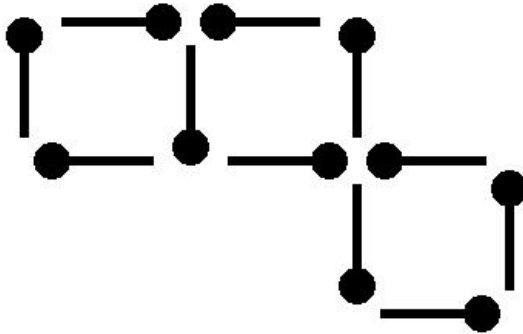

Mind Bending Matches

Your challenge is to move 3 matches to show 2 squares.

Maths Exams 2013

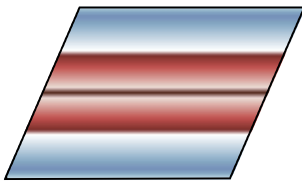

Wednesday
22nd May



Countdown:
Number of full
weeks left:

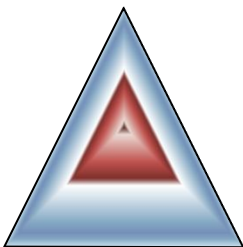

Intermediate 1,
Intermediate 2,
Higher and

Study timetables
should in full
flow!

~~10~~

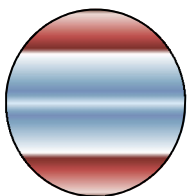

Advanced Higher
Maths exams
take place on the
above date.



3!!