

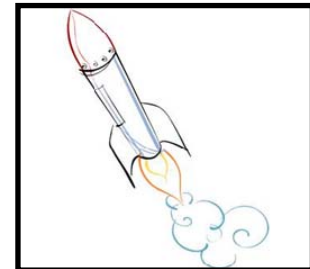

Barrhead High School

Physics Department

N4 N5 Physics

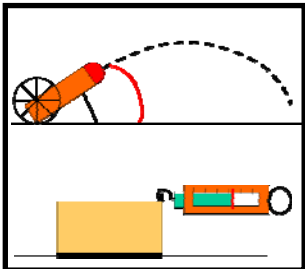
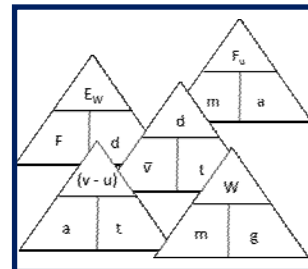
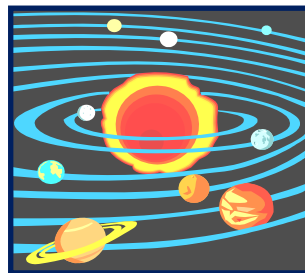
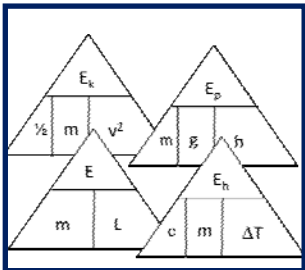
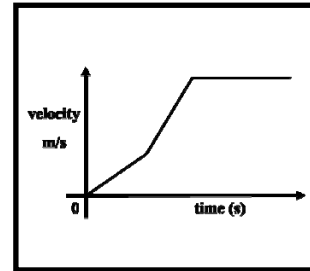
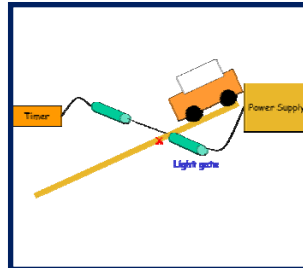

Dynamics & Space Problems

Data Sheet

<i>Speed of light in materials</i>	
<i>Material</i>	<i>Speed in ms⁻¹</i>
Air	3 x 10 ⁸
Carbon dioxide	3 x 10 ⁸
Diamond	1.2 x 10 ⁸
Glass	2.0 x 10 ⁸
Glycerol	2.1 x 10 ⁸
Water	2.3 x 10 ⁸

<i>Speed of sound in materials</i>	
<i>Material</i>	<i>Speed in ms⁻¹</i>
Aluminium	5 200
Air	340
Bone	4 100
Carbon dioxide	270
Glycerol	1 900
Muscle	1 600
Steel	5 200
Tissue	1 500
Water	1 500

<i>Gravitational field strengths</i>	
	<i>Gravitational field strength on the surface in Nkg⁻¹</i>
Earth	9.8
Jupiter	26
Mars	4
Mercury	4
Moon	1.6
Neptune	12
Saturn	11
Sun	270
Venus	9
Uranus	11.7
Pluto	4.2

<i>Specific heat capacity of materials</i>	
<i>Material</i>	<i>Specific heat capacity in J k⁻¹°C⁻¹</i>
Alcohol	2 350
Aluminium	902
Copper	386
Glass	500
Glycerol	2 400
Ice	2 100
Lead	128
Silica	1 033
Water	4 180
Steel	500

<i>Specific latent heat of fusion of materials</i>	
<i>Material</i>	<i>Specific latent heat of fusion in Jkg⁻¹</i>
Alcohol	0.99 x 10 ⁵
Aluminium	3.95 x 10 ⁵
Carbon dioxide	1.80 x 10 ⁵
Copper	2.05 x 10 ⁵
Glycerol	1.81 x 10 ⁵
Lead	0.25 x 10 ⁵
Water	3.34 x 10 ⁵

<i>Melting and boiling points of materials</i>		
<i>Material</i>	<i>Melting point in °C</i>	<i>Boiling point in °C</i>
Alcohol	-98	65
Aluminium	660	2470
Copper	1 077	2 567
Glycerol	18	290
Lead	328	1 737
Turpentine	-10	156

<i>Specific latent heat of vaporisation of materials</i>	
<i>Material</i>	<i>Sp.l.ht vap(Jkg⁻¹)</i>
Alcohol	11.2 x 10 ⁵
Carbon dioxide	3.77 x 10 ⁵
Glycerol	8.30 x 10 ⁵
Turpentine	2.90 x 10 ⁵
Water	22.6 x 10 ⁵

<i>SI Prefixes and Multiplication Factors</i>		
<i>Prefix</i>	<i>Symbol</i>	<i>Factor</i>
giga	G	1 000 000 000=10 ⁹
mega	M	1 000 000 =10 ⁶
kilo	k	1 000 =10 ³
milli	m	0.001 =10 ⁻³
micro	μ	0.000 001 =10 ⁻⁶
nano	n	0.000 000 001=10 ⁻⁹

1. Average Speed

National 4

In this section you can use the equation:

$$\text{average speed} = \frac{\text{distance}}{\text{time}}$$

also written as

$$\bar{v} = \frac{d}{t}$$

Where \bar{v} = average speed in metres per second (ms^{-1})
 d = distance in metres (m)
 t = time in seconds (s).

1. Find the missing values in the following table.

	average speed (ms^{-1})	distance (m)	time (s)
(a)		100	20
(b)		20	4
(c)	25		0.5
(d)	16		55
(e)	1 200	60	
(f)	75	15 000	

2. A car travels a distance of 2 000 metres in a time of 160 seconds. Calculate the average speed of the car in metres per second.

3. Jane jogs to work every day at an average speed of 4 ms^{-1} . Most days it takes her 600 seconds to reach work. Calculate how far she jogs.



4. A model train travels around 10 m of track at an average speed of 1.5 ms^{-1} . How long does this take?
5. Christopher takes 26 seconds to swim one length of a swimming pool. If the pool is 50 metres long calculate his average speed.

6. How far will a cyclist travel in 60 seconds if he is cycling with an average speed of 13 metres per second?



7. Calculate a hurdler's time if she completes the 400 m hurdle race with an average speed of 7 ms^{-1} .

8. How far will a jet aircraft travel in 5 minutes if it flies at 400 metres per second?

9. A train travels 200 km in 1h. How far would it travel in 1 second?

- 10.

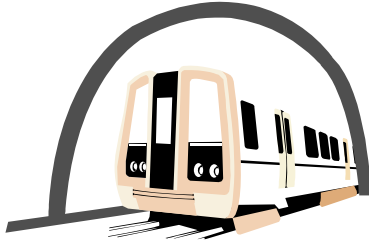

The Channel Tunnel is approximately 50 km long. How long will it take a train travelling at 90 ms^{-1} to travel from one end of the tunnel to the other?

11. A hill walker walks at an average speed of 1.6 ms^{-1} . How long will it take her to cover a distance of 33 km?

12. A lorry takes 4 hours to travel 150 km. Calculate the average speed of the lorry in ms^{-1} .

13. In 1889 the first Daimler car reached a speed of 20 kmh^{-1} . How far would the Daimler car travel in 3 hours 30 minutes if it travelled at a constant speed of 20 kmh^{-1} ? (HINT: keep speed in kmh^{-1} and time in h, then distance will be in km.)

14. Richard Noble captured the world land speed record in 1983 in his vehicle Thrust 2. The car travelled one kilometre in 3.5 seconds. Calculate the average speed of the car.

15. The French TGV train is one of the fastest commercial trains ever to operate. Its maximum speed is 270 kmh^{-1} .

(a) Calculate its maximum speed in ms^{-1} .

(b) The TGV takes 2 hours to travel the 425 km between Paris and Lyon. Calculate its average speed for this journey in kmh^{-1} .

16. The table below shows part of a timetable for the Glasgow to Aberdeen Inter-City Express.

<i>Station</i>	<i>Departure time</i>	<i>Distance (km)</i>
Glasgow	1025	0
Perth	1125	100
Dundee	1148	142
Aberdeen	1324	250

- (a) Calculate the average speed of the train in ms^{-1} over the whole journey.
 (b) Between which stations is the train's average speed greatest?
17. The Wright brothers were the first people to fly an aeroplane. Their first flight in 1903 lasted only 12 seconds and covered just 36 metres.



- (a) Calculate the average speed of the plane during that first journey.
 (b) Today Concorde can fly at Mach 2 (twice the speed of sound). How long would it take Concorde to travel 36 metres?
 (Speed of sound in air = 340 ms^{-1})
18. A long distance lorry driver has 3 hours to travel 210 km to the cross channel ferry.

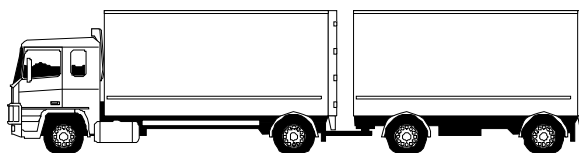

- (a) Calculate the average speed at which the lorry must travel in order to reach the ferry on time. Give your answer in kmh^{-1} .
 (b) Due to heavy traffic the lorry has an average speed of 60 kmh^{-1} for the first 100 km. Calculate how long this leg of the journey takes.
 (c) At what speed must the lorry travel for the rest of the journey if the driver is to catch the ferry? Give your answer in kmh^{-1} .

19. The cheetah is the fastest mammal on earth. It can run at an average speed of 40 ms^{-1} but can only maintain this speed for short periods of time. Cheetahs prey on antelopes. The average speed of an antelope is 35 ms^{-1} . The antelope can maintain this speed for several minutes.
- Calculate how far a cheetah could run in 12 seconds if it maintained an average speed of 40 ms^{-1} .
 - How long would it take an antelope to run 480 m?
 - A cheetah is 80 m away from an antelope when it begins to chase it. The antelope sees the cheetah and starts to run at the same instant that the cheetah begins its chase. Both animals run at their average speeds and the cheetah is able to run for 15 s. Show by calculation whether or not the cheetah catches the antelope.
20. Before a major motor race the competitors complete practice circuits in their cars. These practice runs are timed and used to determine the position of each car at the starting grid for the race. The race circuit is 3.6 km long.

In a particular race each driver completed four practice laps. The practice lap times for the top three drivers are shown in the table.

Driver Name	Lap Times (s)			
	1	2	3	4
Mickey	45.8	43.4	46.4	48.2
Donald	44.7	46.2	44.6	49.5
Goofy	46.3	44.8	45.1	43.8

- Which driver had the greatest average speed during lap 1?
- Calculate the greatest average speed during lap 2.
- For each driver calculate the average speed in metres per second for the complete practice run.
- Which driver is most likely to win the race?

2. Instantaneous Speed

National 4

In this section you can use the idea that:

instantaneous speed = average speed over as short a time as possible

also written as

$$v_i = \frac{d}{t}$$

where

v_i	= instantaneous speed in metres per second (ms^{-1})
d	= distance in metres (m)
t	= time in seconds (s).

- The following experiment is used for measuring the instantaneous speed of a trolley as it travels down a runway.

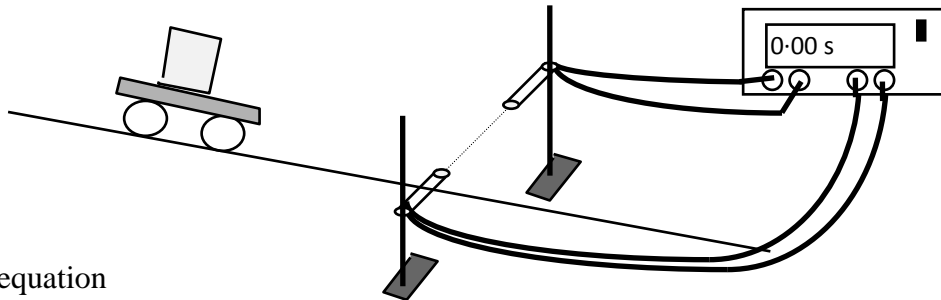

Use the equation

$$\text{instantaneous speed} = \frac{\text{length of card}}{\text{time to cut beam}}$$

to find the missing values in the following table:

	<i>instantaneous speed</i> (ms^{-1})	<i>card length</i> (m)	<i>time</i> (s)
(a)		0.2	0.10
(b)		0.1	0.10
(c)		0.08	0.04
(d)		0.14	0.2
(e)		0.15	0.3
(f)		0.3	0.4

- A car of length 3.5 m passes a student. The student records a time of 2.4 s between the front and the back of the car passing her. Calculate the instantaneous speed of the car.

3. A runner decides to analyse his track performance in order to improve his overall running time during the 400 m event. He sets up light gates at six points round the track so that he can work out his instantaneous speed at each point.

$\text{instantaneous speed} = \frac{\text{width of runner}}{\text{time to cut beam}}$

The results he recorded are shown below.

<i>Position</i>	<i>width of runner (m)</i>	<i>time (s)</i>	<i>instantaneous speed (ms⁻¹)</i>
A	0.2	0.025	
B	0.2	0.026	
C	0.2	0.030	
D	0.2	0.029	
E	0.2	0.025	
F	0.2	0.024	

Use the results to calculate his instantaneous speed at each position and hence say at which point is he running:

- (a) fastest
 (b) slowest
4. A train of length 150 m takes 1.42 s to enter a tunnel.
 Calculate the instantaneous speed of the train.
5. The following experiment is set up to investigate the change in speed as a trolley rolls down a ramp.

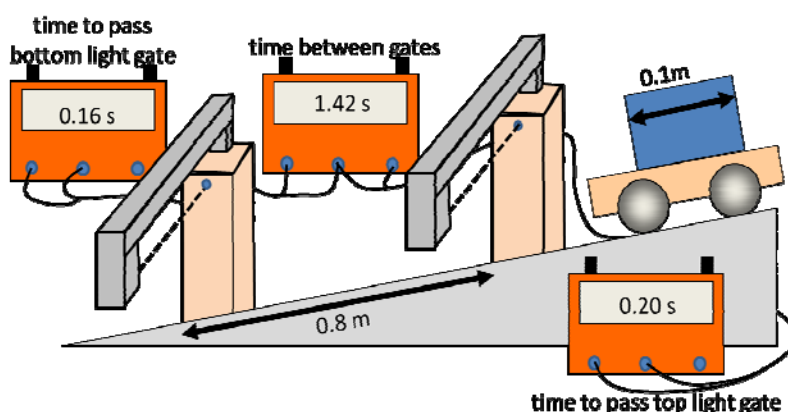

- (a) Calculate the speed of the trolley as it passes through the top light gate.
 (b) Calculate the speed of the trolley as it passes through the bottom light gate.
 (c) Calculate the average speed of the trolley on the ramp.

3. Vectors and Scalars

National 5

1. Describe what is meant by a scalar quantity.
2. Describe what is meant by a vector quantity.
3. Read the following descriptions of some quantities used in Physics:

Distance travelled by an object is the total length covered during a journey. Direction is irrelevant.

Velocity is the speed of an object in a specified direction.

Acceleration tells us how much the velocity of an object changes each second. Because it is about a change in velocity, then direction is important.

Energy tells us about an object's ability to do work. Direction is not important.

Speed is the distance covered in a specified time. As direction is not relevant for defining distance and time, so it is not relevant in defining speed.

Displacement is the change in position of an object specified by a distance *and* a corresponding direction.

- (a) Which of the quantities underlined in bold are scalar quantities. Explain your answer.
- (b) Which of the quantities underlined in bold are vector quantities. Explain your answer.

4. Distance and Displacement

National 5

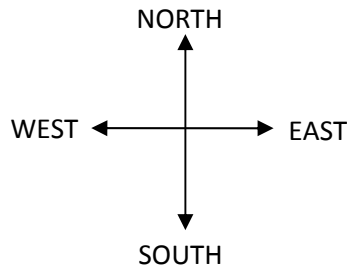

1. A boy walks 50 m, East then runs for 100 m in the same direction.



- (a) State the distance travelled by the boy.
(b) State the final displacement of the boy from the start point. (Remember to give a direction!)

2. A girl runs 100 m, East then walks for 50 m in the opposite direction.

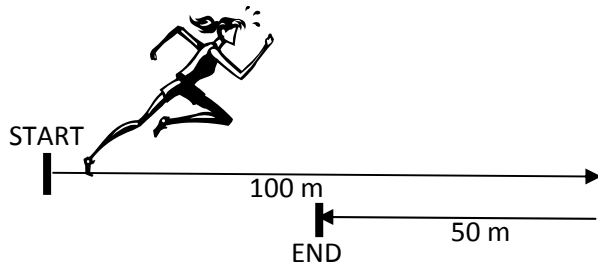

- (a) State the distance travelled by the girl.
(b) State the final displacement of the girl from the start point. (Remember to give a direction!)

3. A delivery lorry travels 80 km, North then travels South for 100 km.

- (a) State the distance travelled by the lorry.
(b) State the final displacement of the lorry for this journey.

4. During a hike, a hillwalker walks 60 m, South then backtracks 20 m, North.

- (a) State the distance covered by the hillwalker.
(b) State the displacement of the hillwalker for this stage of the hike.

5. A girl walks from X to Y along a winding road as shown below.

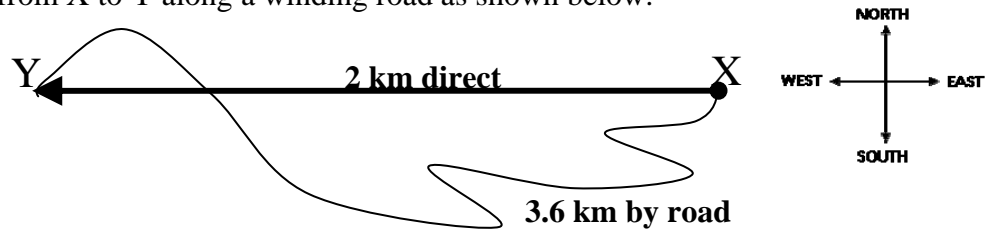

- (a) State the distance travelled by the girl.
 (b) State the displacement of the girl at Y, from X.

6. Displacement directions can be described using an angle with compass points OR using a three figure bearing; where the angle is clockwise from the North line.

For example

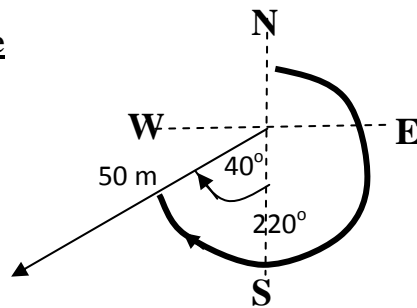

this displacement is
"50m @ 40° W of S"

OR

"50m @ 220°"

Describe each of the following displacements using appropriate compass points and with a three figure bearing.

- (a)

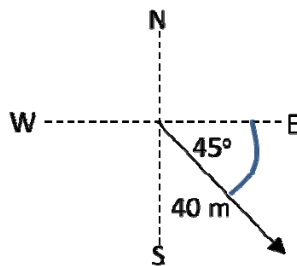

- (b)

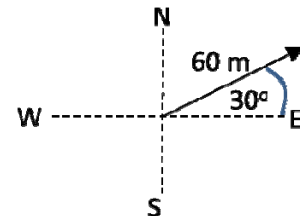

- (c)

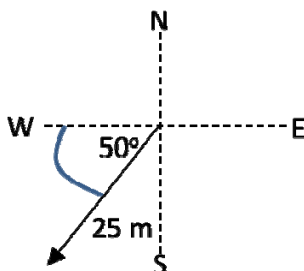

- (d)

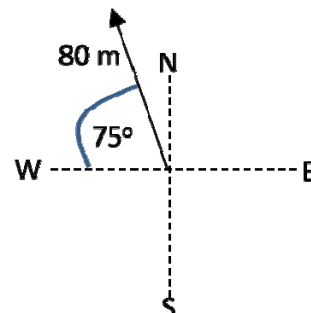

7. During an orienteering exercise, a boy walks 30 m, North then 40 m, West.

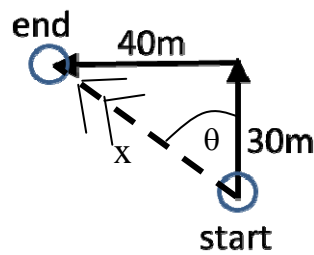

- (a) State the distance travelled during this exercise.
- (b) Draw a scale diagram and use it to calculate the magnitude of the boy's displacement, x .
- (c) From your scale diagram, measure the direction, θ , of this displacement.
- (d) Give this angle as a three figure bearing.
8. A man walks 500 m, due North then 1200 m due West.
- (a) State the distance travelled by the man.
- (b) Use scale drawing, or otherwise, to determine the final displacement of the man from his starting point.
9. A surveyor walks once around the perimeter of a rectangular field, measuring 80 m by 150 m, returning to his starting point.
- (a) State the distance covered by the surveyor.
- (b) What is the displacement of the surveyor when he returns to his starting point.
10. A yacht sails 5 km due West followed by 3 km, North.
- (a) State the distance travelled by the yacht.
- (b) Calculate the final displacement of the yacht from its starting point.
11. A car travels 8 km, East followed by 8 km, South.
- (a) State the distance travelled by the car.
- (b) Calculate the final displacement of the car from its starting point.
12. A cyclist cycles 5 km, North, then 4 km, West followed by 8 km, South.
- (a) State the distance travelled by the cyclist.
- (b) Calculate the displacement of the cyclist for this journey.

5. Speed and Velocity

National 5

In this section you can use the equations:

$$\text{speed} = \frac{\text{distance}}{\text{time}}$$

AND

$$\text{velocity} = \frac{\text{displacement}}{\text{time}}$$

also written as

$$\text{speed} = \frac{d}{t}$$

$$v = \frac{s}{t}$$

Where

- d** = distance in metres (m)
- v** = velocity in metres per second (ms^{-1})
- s** = displacement in metres (m)
- t** = time in seconds (s)
- speed** is in metres per second (ms^{-1})

1. One lap of a running track is 400 m. An athlete completes this lap in 48 s.
 - (a) State the distance travelled by the athlete.
 - (b) State the displacement of the athlete.
 - (c) Calculate the average speed of the athlete.
 - (d) Calculate the average velocity of the athlete.

2. A girl runs 200 m, West then walks 50 m East. It takes her 50 seconds to do this.

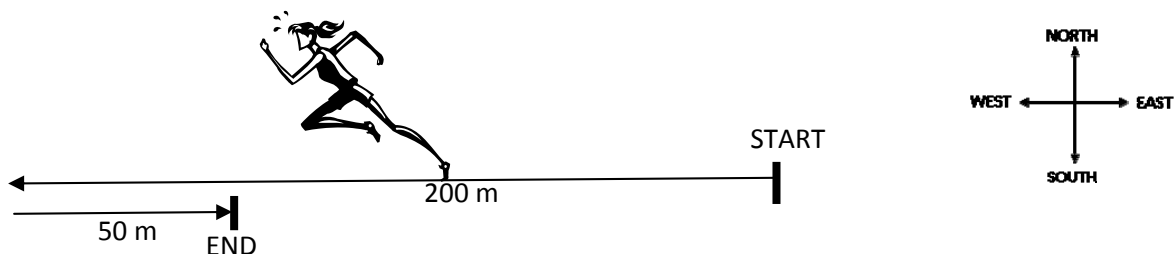

- (a) State the distance travelled by the girl.
 - (b) State the overall displacement of the girl.
 - (c) Calculate the girl's average speed.
 - (d) Calculate the girl's average velocity.

3. A walker travels from A to B along a winding path as shown below. The 5 km walk takes the walker 70 minutes. As the crow flies, B is only 3 km from A, at 085° .

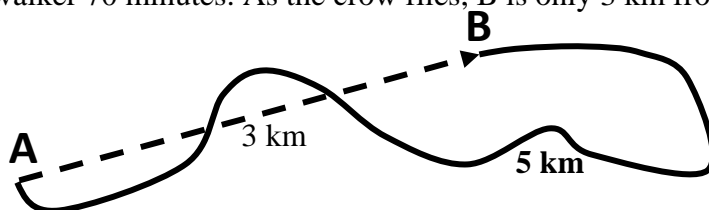

- (a) Calculate the average speed of the walker in ms^{-1} .
 - (b) Calculate the average velocity of the walker in ms^{-1} .

4. A girl takes 1 hour to hike from X to Y along a winding road as shown below.

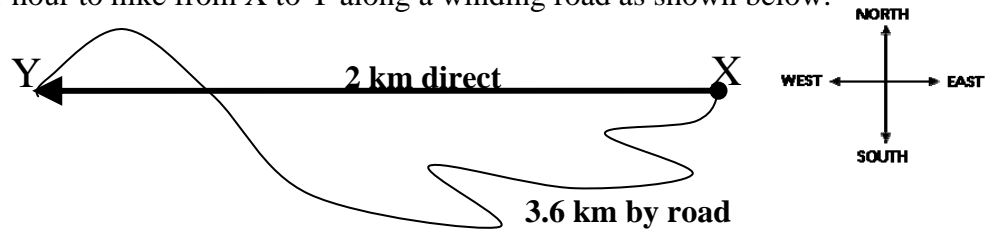

- (a) Calculate the average speed of the girl in km h^{-1} .
 (b) Calculate the average velocity of the girl in km h^{-1} .
5. A car travels 80 km, North, then 20 km, South. The journey takes 2 hours.
- (a) State the distance travelled by the car.
 (b) State the overall displacement of the car in this time.
 (c) Calculate the car's average speed in km h^{-1} .
 (d) Calculate the car's average velocity in km h^{-1} .

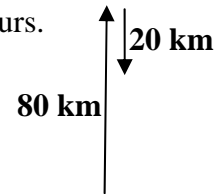

6. A lorry travels 60 km, North, then 80 km, East, as shown here. The journey takes 2 hours.

- (a) State the distance travelled by the lorry.
 (b) Calculate the overall displacement of the lorry.
 (c) Calculate the lorry's average speed in km h^{-1} .
 (d) Calculate the lorry's average velocity in km h^{-1} .

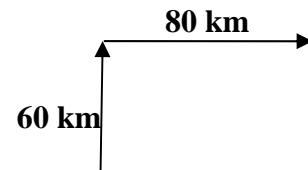

7. A boy delivers newspapers to three houses; X, Y and Z, as shown in the diagram below. It takes him 1 minute to reach house Z from house X.

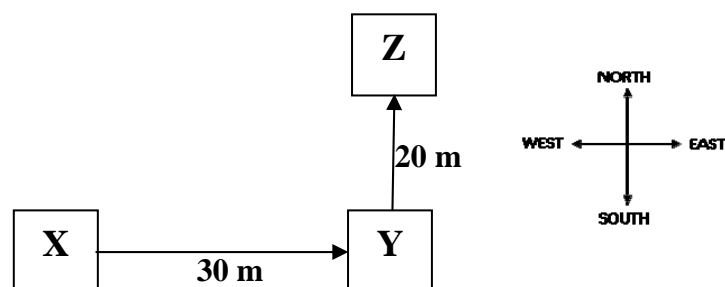

- (a) State the distance covered by the boy.
 (b) When he reaches house Z, what is the boy's displacement from house X?
 (c) Calculate the average speed of the boy between houses X and Y.
 (d) Calculate the average velocity of the boy between houses X and Y.

8. A cyclist cycles 500 m, West, followed by 600 m, South, in 110 seconds.
- State the distance travelled by the cyclist.
 - Calculate the overall displacement of the cyclist for the 110 s period.
 - Calculate the average speed of the cyclist.
 - Calculate the cyclist's average velocity.
9. During a section of a yacht race, a yacht sails 800 m, East, followed by 400 m, North, with a steady speed of 12 ms^{-1} .
- State the distance travelled by the yacht.
 - Calculate the displacement of the yacht for this section of the race.
 - Calculate the time taken for the yacht to complete this section of the race.
 - Calculate the average velocity of the yacht.
10. A tortoise moves 5 m, South, followed by 3 m, East, with a steady speed of 0.2 ms^{-1} .
- State the distance travelled by the tortoise.
 - Calculate the displacement of the tortoise from its start point.
 - Calculate the time taken for the tortoise to do this.
 - Calculate the average velocity of the tortoise.
11. A robot moves 6 m, North, followed by 6 m, East, at a steady speed of 2 ms^{-1} .
- State the distance travelled by the robot.
 - Calculate the displacement of the robot from his start point.
 - Calculate the time taken for the robot to complete these moves.
 - Calculate the average velocity of the robot.
12. An orienteer runs 5 km, South, followed by 4 km, West, followed by 2 km, North, in 3 hours.

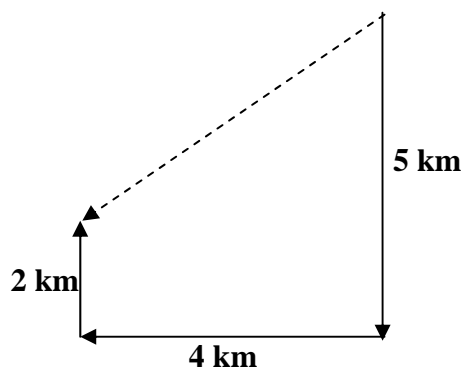

- State the distance travelled by the orienteer.
- Calculate the overall displacement of the orienteer.
- Calculate the orienteer's average speed in km h^{-1} .
- Calculate the orienteer's average velocity in km h^{-1} .

6. Combining Velocities

National 5

1. For each of the following combinations of velocities, draw a diagram to represent the velocities involved and the resultant velocity. **Remember to draw the given velocities NOSE TO TAIL.** The first diagram is drawn for you.

“ x ” is the magnitude of the resultant velocity.

“ θ ” is the direction of the resultant velocity, usually given as a three figure bearing.

- (a) 3 ms^{-1} , North and 4 ms^{-1} , East.

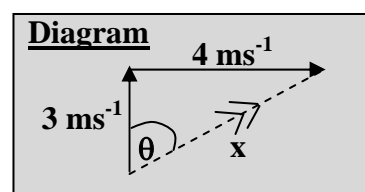
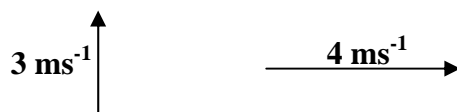

- (b) 6 ms^{-1} , South and 4 ms^{-1} , West.

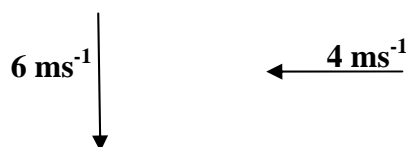

- (c) 2 ms^{-1} , West and 5 ms^{-1} , North.

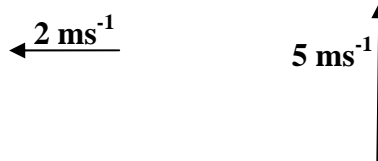

2. A boy aims to swim South across a river with a velocity of 4 ms^{-1} . The river's velocity is 8 ms^{-1} , West.

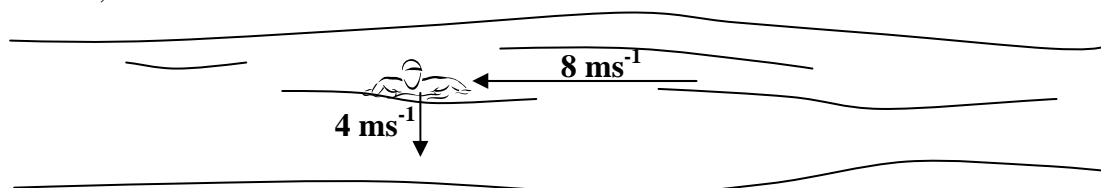

Calculate the resultant velocity of the boy.

3. A girl aims to swim North across a river with a velocity of 3 ms^{-1} . This river's velocity is 6 ms^{-1} , East.
Calculate the resultant velocity of the girl.

4. A pilot selects a course of 100 kmh^{-1} due West.
A wind is blowing with a velocity of 40 kmh^{-1} , due South.
Calculate the resultant velocity of the plane.

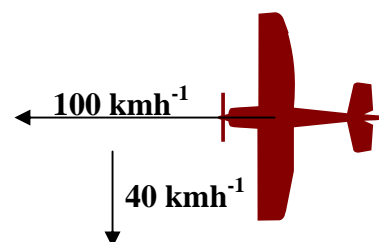

5. A pilot selects a course of 180 kmh^{-1} , due East.
A wind is blowing with a velocity of 50 kmh^{-1} , due North.

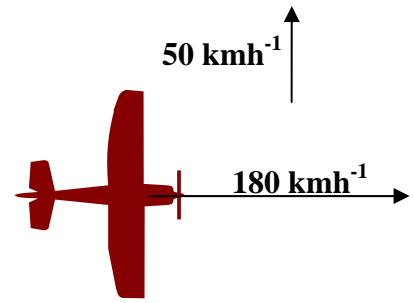

- (a) Show that the resultant velocity of the plane is 187 kmh^{-1} at 16° North of East.
- (b) Use your answer to part (a) to suggest what course the pilot *should* select to make sure he ends up moving at 180 kmh^{-1} due East in this wind.
6. An aeroplane is flying with its course set at 1000 kmh^{-1} , North.
It is flying into a wind which has a velocity of 100 kmh^{-1} , South.
Calculate the resultant velocity of the aeroplane.
7. An aircraft pilot sets a course for 800 kmh^{-1} , North.
A wind is blowing at 80 kmh^{-1} from West to East.
- (a) Calculate the resultant velocity of the plane. (You should sketch a suitable diagram first.)
- (b) Use your answer to part (a) to suggest what course the pilot *should* select so that the plane does fly at 800 kmh^{-1} due North.
8. A model aircraft is flying North at 24 ms^{-1} .
A wind is blowing from West to East at 10 ms^{-1} .
Draw a suitable diagram and use it to calculate the resultant velocity of the model aircraft.
9. A ship is sailing East at 4 ms^{-1} on calm waters.
A passenger on the deck walks at 2 ms^{-1} due North.
Draw a suitable diagram and use it to calculate the resultant velocity of the passenger.
10. On still water, a remote controlled toy boat moves at 3.6 ms^{-1} .
The boat is set to move West across a river but the river is flowing at 4.8 ms^{-1} North.
Calculate the resultant velocity of the boat.

7. Motion Graphs (qualitative)

National 4 – Speed v Time Graphs

Speed time graphs can be used to describe the motion of a vehicle.

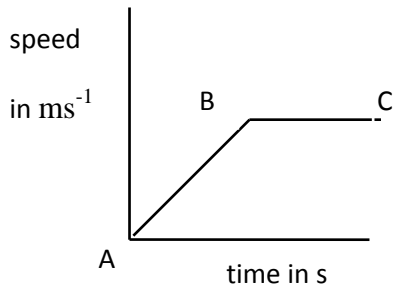

A→B: car accelerates from rest

B→C: car travels at a constant speed

1. Describe the motion shown in each of the following speed – time graphs.

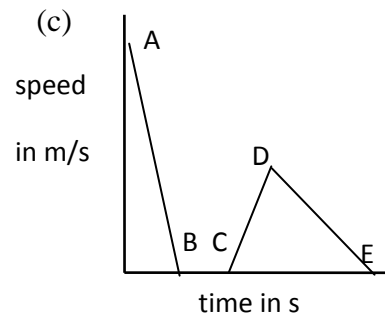
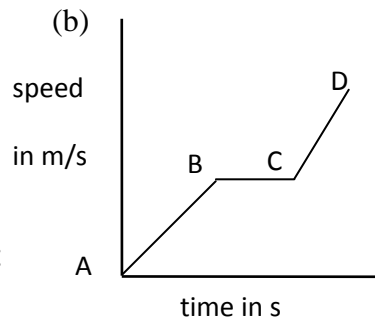
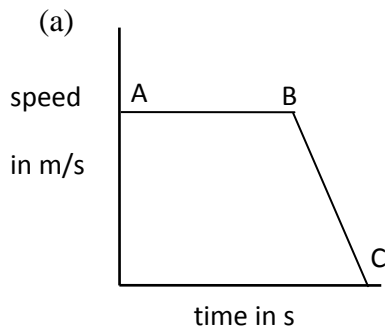

2. Draw speed time graphs to represent each of the following journeys.

(a)

<i>time (s)</i>	0	2	4	6	8	10	12
<i>speed (m/s)</i>	0	5	10	15	15	15	0

(b)

<i>time (s)</i>	0	1	2	3	4	5	6
<i>speed (m/s)</i>	0	20	40	30	30	10	0

(c)

<i>time (s)</i>	0	10	20	30	40	50	60
<i>speed (m/s)</i>	50	40	30	20	10	60	0

(d)

<i>time (s)</i>	0	5	10	15	20	25	30
<i>speed (m/s)</i>	0	100	150	175	200	200	0

8. Acceleration Calculations

National 4

In this section you can use the equation:

$$\text{acceleration} = \frac{\text{change in speed}}{\text{time taken for change}}$$

also written as

$$a = \frac{\Delta v}{t}$$

where

Δv = change in speed in metres per second (m/s)

a = acceleration in metres per second per second (m/s²)

t = time taken for change in speed in seconds (s).

1. Find the missing values in the following table .

	<i>Acceleration (m/s²)</i>	<i>Change in Speed (m/s)</i>	<i>Time taken (s)</i>
(a)		12	6
(b)		20	5
(c)		9	180
(d)		240	600
(e)		12	4
(f)		45	9

2. A car, starting from rest, reaches a speed of 15 metres per second in a time of 30 seconds. Calculate the acceleration of the car.
3. A sprinter in a race crossed the finishing line with a speed of 14 m/s. If her sprint time was 16 seconds, what was her average acceleration?
4. A ball is dropped from the roof of a building. What is the acceleration of the ball if its speed is 30 m/s after 3 seconds?
5. What is the acceleration of a lorry which increases its speed from 5 m/s to 15 m/s in 40 seconds?
6. A train increases its speed from 15 m/s to 25 m/s in a time of 8 seconds. Calculate the acceleration of the train.

National 5

At National 5 level you will usually be expected to use the word “velocity” instead of “speed” when dealing with acceleration calculations.

$$\text{acceleration} = \frac{\text{change in velocity}}{\text{time taken}}$$

also written as

$$a = \frac{v - u}{t}$$

where **u** = initial velocity in metres per second (ms^{-1})
v = final velocity in metres per second (ms^{-1})
a = acceleration in metres per second per second (ms^{-2})
t = time taken for change in velocity in seconds (s).

**Sometimes the velocities are given in kmh^{-1} .
If this is the case, the unit for acceleration is $\text{kmh}^{-1} \text{s}^{-1}$.**

Likewise, if the velocities are in “miles per hour” (mph), the unit for acceleration is mph s^{-1} .

7. A coach accelerates from 30 kmh^{-1} to 50 kmh^{-1} in 50 seconds. What is its acceleration in $\text{km h}^{-1} \text{s}^{-1}$?
8. A ball takes 1 minute to roll down a hill. Calculate its acceleration, given that it has a velocity of 30 ms^{-1} at the foot of the hill and that it started from rest.
9. Car A can accelerate from rest to 60 kmh^{-1} in a time of 5 seconds. Car B can accelerate from rest to 60 kmh^{-1} in a time of 4 seconds. By how much is the acceleration of car B greater than that of car A?
10. A car accelerates from 30 mph to 60 mph in 30 seconds.

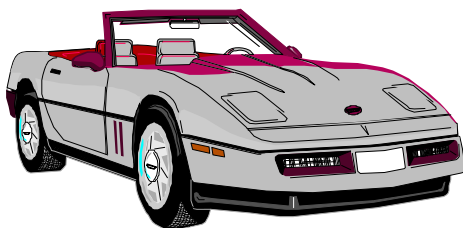

Calculate its acceleration in mph s^{-1} .

11. A train, which had been travelling at 18 ms^{-1} , took 12 seconds to stop from the moment the brakes were applied. What was the deceleration of the train?

12. A bus, travelling at 16 ms^{-1} , takes 32 seconds to come to rest. Calculate the deceleration of the bus.

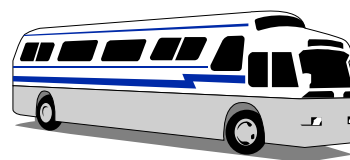

13. What is the deceleration of a car which slows down from 10 ms^{-1} to 4 ms^{-1} in 8 seconds?

14.



It takes 20 seconds for an ice skater to come to rest after skating with a velocity of 8 ms^{-1} . What is her deceleration?

15. A racing car travelling at 20 ms^{-1} accelerates at a rate of 2 ms^{-2} for 4 seconds.

- (a) Calculate its change in velocity.
(b) What is its final velocity, after 4 seconds of acceleration?

16. A remote controlled car accelerated at 0.1 ms^{-2} for half a minute. If it had an initial velocity of 0.2 ms^{-1} , what was its final velocity?

17. A hot air balloon travels upwards with a constant velocity. It then accelerates at 0.08 ms^{-2} for 1 minute. If it reaches a velocity of 5 ms^{-1} , what was its initial velocity just before the acceleration?

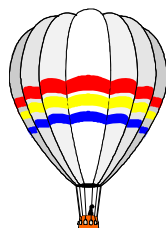

18. A train is accelerating at a rate of 1.2 ms^{-2} . How long will it take for the velocity of the train to increase from 5 ms^{-1} to 16.4 ms^{-1} ?

19. A boy is cycling on a flat road with a velocity of 12 ms^{-1} when he stops pedalling. He decelerates at a rate of 0.4 ms^{-2} . How long does he take to stop?

20. A train travelling at 54 kmh^{-1} increases its speed to 72 kmh^{-1} in a time of 20 seconds. Calculate the acceleration of the train in $\text{kmh}^{-1} \text{ s}^{-1}$.

21. A hot air balloon accelerates upwards from the ground at 0.05 ms^{-2} . It maintains this acceleration for the first 40 seconds of its flight. One sandbag is then released which increases the acceleration of the balloon to 0.08 ms^{-2} .

- (a) What is the velocity of the balloon 40 seconds after it has been released from the ground?
(b) What is the velocity of the balloon 20 seconds after the sandbag is released?

22. Two identical balls are dropped from rest.
 Ball A takes 0.4 s to land. Ball B lands on the floor 0.1 s after ball A.
 Both balls accelerate towards the ground at 10 ms^{-2} .

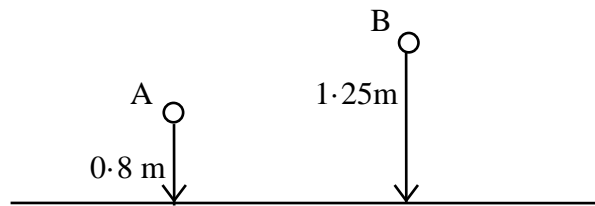

What is the maximum velocity reached by each ball?

23. A car accelerates at a rate of 0.3 ms^{-2} for 15 seconds and reaches a velocity of 18 ms^{-1} .
 What was its original velocity?

24. Two identical balls are fired upwards, with a velocity of 6.4 ms^{-1} , from two identical springs.



One ball is on Earth and decelerates at a rate of approximately 10 ms^{-2} , after leaving the spring.

The other ball is on the Moon and decelerates at a rate of 1.6 ms^{-2} .

- (a) What is the velocity of each ball at its maximum height?
 (b) How long does it take for each ball to reach its maximum height?
25. A bus travelling with a constant velocity decelerates at a rate of 0.8 ms^{-2} for 4 s. If its velocity drops to 12 ms^{-1} , what was the initial velocity of the bus?

9. Velocity – Time Graph Calculations

National 5

Helpful Hint

Velocity - time graphs can be used to calculate the **acceleration (a)** of an object.

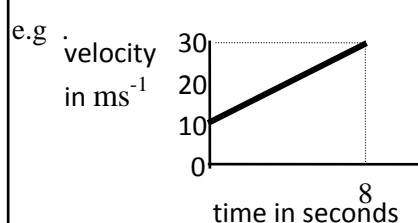

From the graph: initial velocity (u) = 10 ms^{-1}
 final velocity (v) = 30 ms^{-1}
 time taken (t) = 8 s

So, using: $a = \frac{v - u}{t}$ $a = \frac{30 - 10}{8} = \underline{2.5 \text{ ms}^{-2}}$

1. Use the graphs below to calculate the **acceleration** over the interval shown.

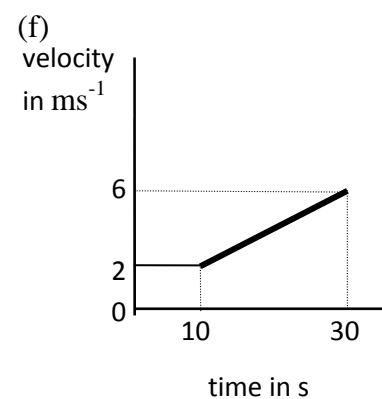
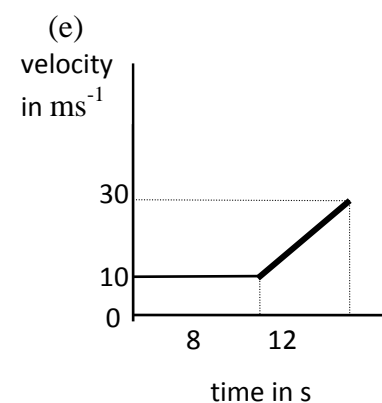
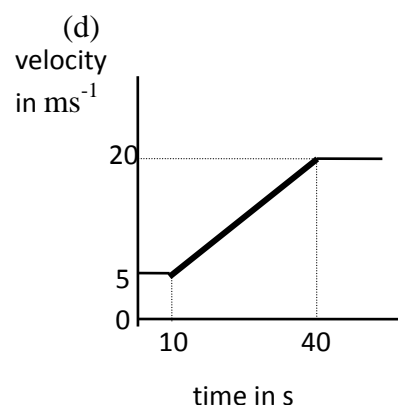
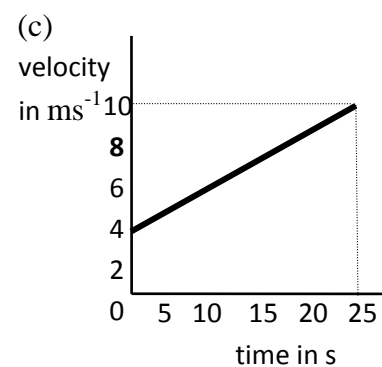
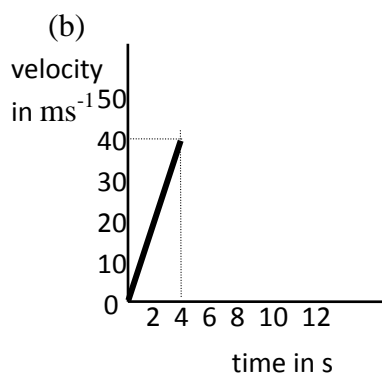
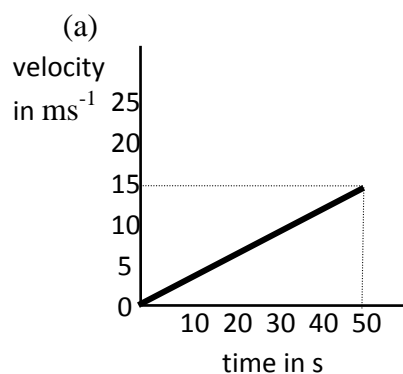

2. This graph shows the journey of a car over a 20s interval.

Calculate the acceleration of the car between:

- (a) 0 and 10 seconds
 (b) 10 and 20 seconds.

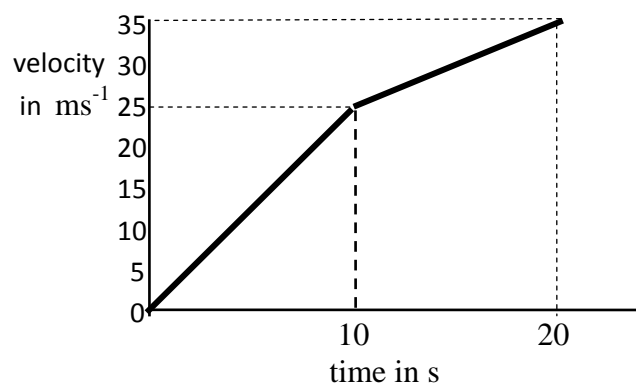

3. Use the velocity - time graph below to calculate the acceleration between:

(a) A and B

(b) B and C.

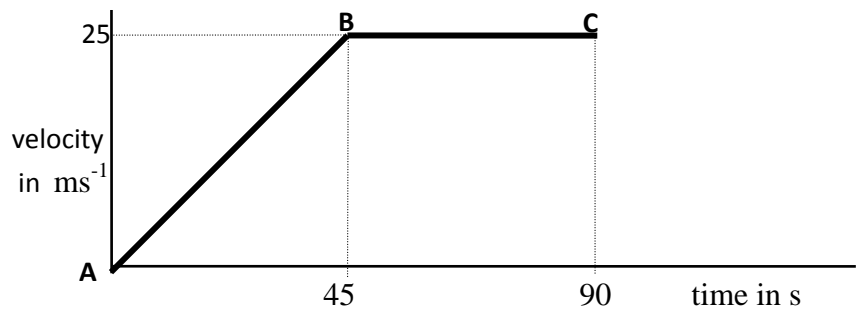

4. A car changes from 4th to 3rd to 2nd gear as it approaches traffic lights. The velocity - time graph representing the car's motion is shown below. Use the graph to calculate the deceleration of the car in each gear.

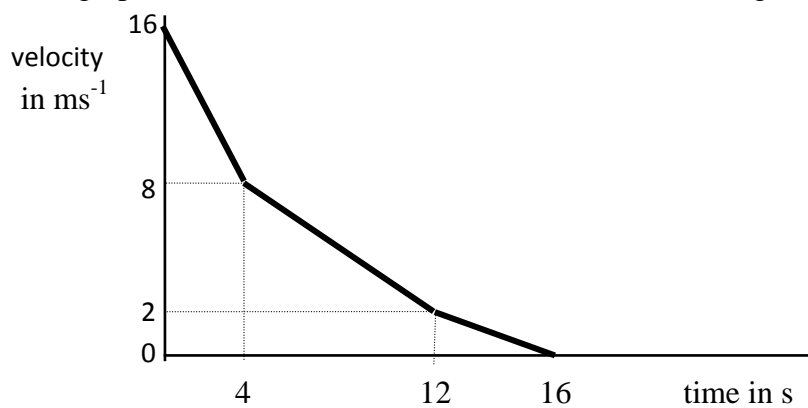

5. Lorry drivers use tachographs to record information about their journeys. A section of one journey is represented by the the graph below.

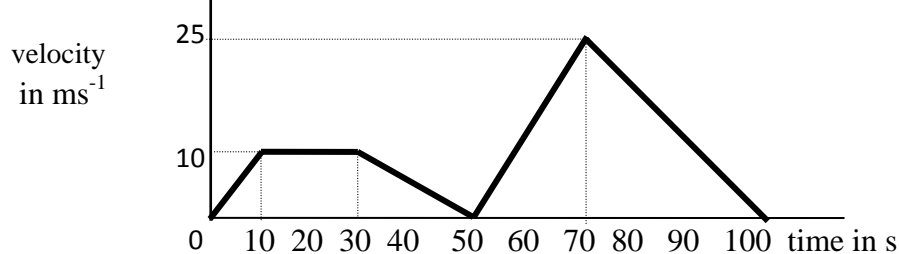

(a) During what time interval was the lorry's acceleration greatest?

(b) When was the lorry stationary?

(c) Calculate the deceleration of the lorry before it finally stopped.

6. Draw speed time graphs to represent the following motions:

(a) a motor cycle **accelerating** at 2 ms^{-2} for 8 seconds from rest.

(b) a car **accelerating** at 5 ms^{-2} for 10 seconds from rest.

(c) a train **accelerating** at 2.5 ms^{-2} for 7 seconds from rest.

Using velocity - time graphs to calculate displacement.

Helpful Hint

To work out the displacement of an object during an acceleration or deceleration you must use:

$$\text{displacement} = \text{area under velocity - time graph}$$

or

$$\text{distance} = \text{area under speed - time graph}$$

You **cannot** use:

$$\text{distance} = \text{speed} \times \text{time.}$$

as this is **only** for objects travelling at a constant speed.

7. Use the velocity - time graphs below to calculate the total displacement for each journey.

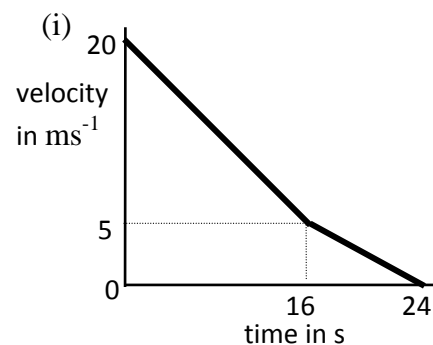
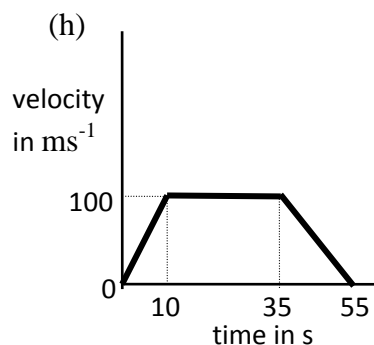
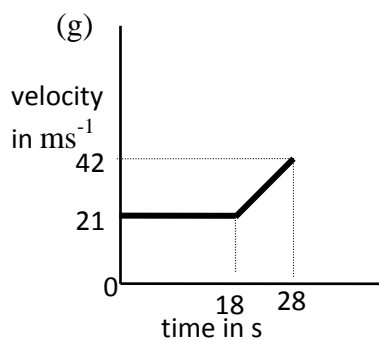
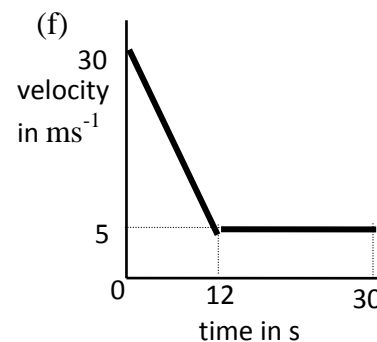
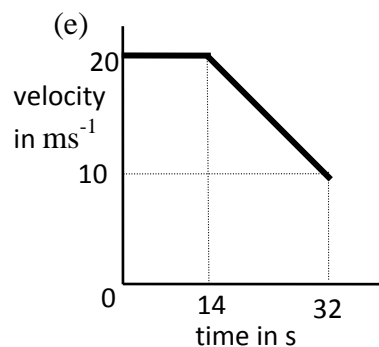
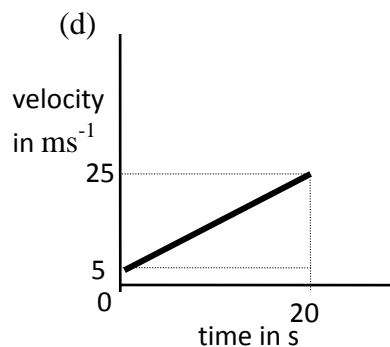
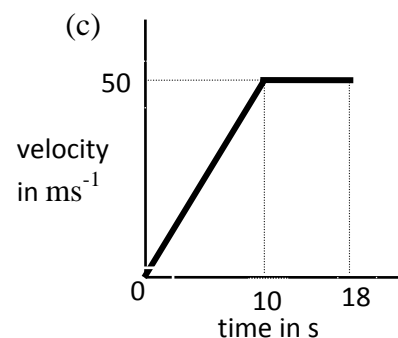
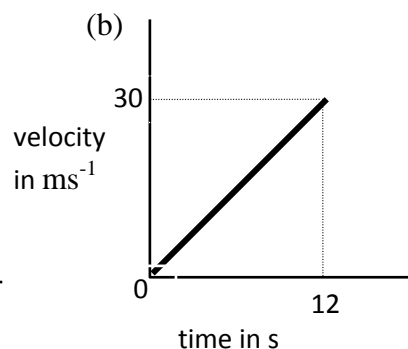
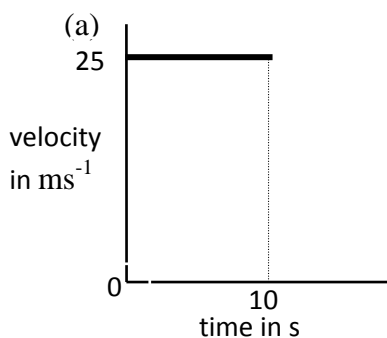

8. While driving along a motorway a driver spots an accident and brakes. The graph below represents the motion of the car from the instant the driver sees the accident.

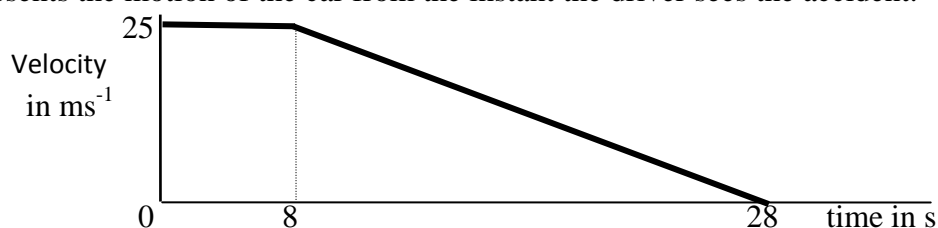

- (a) When did the driver brake?
 (b) Calculate how far the car travelled before braking.
 (c) Calculate how far the car travelled after the driver braked.
9. Draw a velocity - time graph to represent the following motion recorded for a train leaving a station.

<i>time (s)</i>	0	10	20	30	40	50	60	70	80	90
<i>velocity (ms⁻¹)</i>	0	5	10	15	20	25	25	25	30	30

Use the graph to calculate:

- (a) the acceleration of the train during the first 50 seconds
 (b) the displacement of the train at 90 seconds.
10. Draw a velocity - time graph to represent the following motion recorded as a car approaches traffic lights.

<i>time (s)</i>	0	10	20	30	40	50	60	70	80	90
<i>velocity (ms⁻¹)</i>	20	20	20	15	15	10	10	5	5	0

Use the graph to calculate:

- (a) the deceleration of the car between 60 seconds and 70 seconds
 (b) the displacement of the car from its start point at 90 seconds.
11. A hang glider is cruising over choppy waters at a velocity of 15 m/s when the wind direction suddenly changes and sends him into a deep dive.

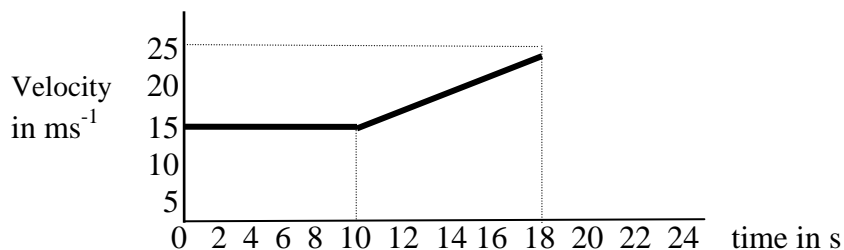

- (a) State when the dive started
 (b) Calculate how far he travelled during the dive.

12. The motion of a rocket as it approaches the Moon is shown below.

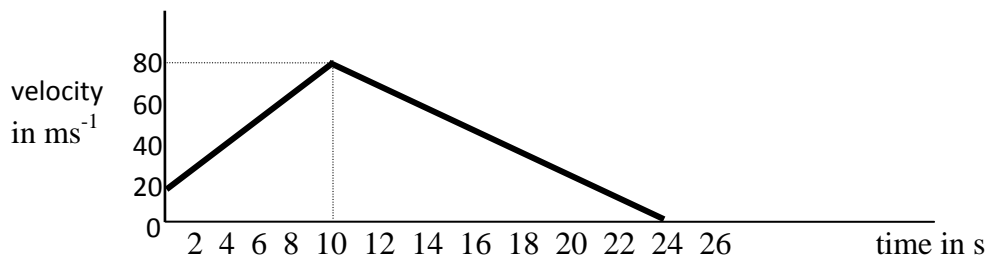

- Calculate the distance the rocket travelled during the time it was accelerating.
- Does the rocket actually reach the Moon's surface if it is 580 metres above it when its deceleration begins? You must justify your answer.

13. Use the velocity - time graph of a falling ball shown below to find :

- when the ball strikes the ground
- the height from which the ball was dropped.

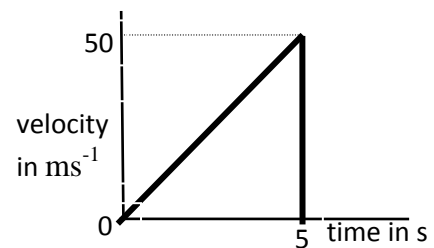

14. How far does a golf ball travel if the velocity - time graph for its flight is as shown below.

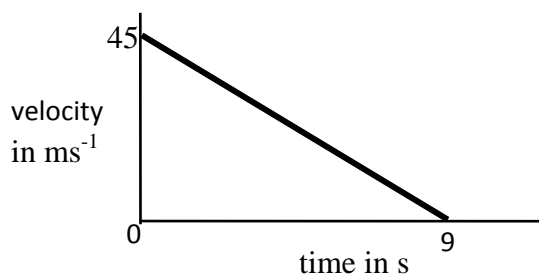

15. Part of a bus journey is represented by the speed time graph below.

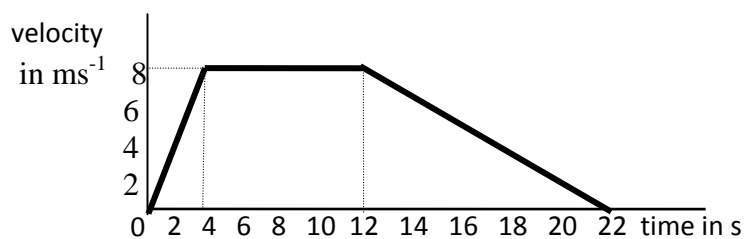

Use the graph to calculate :

- the initial acceleration of the bus
- the total distance travelled by the bus
- the average speed of the bus.

10. Mass and Weight

National 4 and National 5

In this section you can use the equation:

$$\text{weight} = \text{mass} \times \text{gravitational field strength}$$

also written as

$$W = m g$$

where W = weight in newtons (N)
 m = mass in kilograms (kg)
 g = gravitational field strength in newtons per kilogram (N/kg or Nkg^{-1}).

1. Find the missing values in the following table.

	<i>Weight (N)</i>	<i>Mass (kg)</i>	<i>Gravitational field strength (N/kg)</i>
(a)		300	10.0
(b)		0.6	3.7
(c)		0.2	11.7
(d)	230		10.0
(e)	1 680		11.7
(f)	69	6.0	

2. Calculate the weight of each of the following on Earth where the gravitational field strength is approximately 10 N/kg :
- (a) a girl whose mass is 50 kg
 - (b) a dog of mass 20 kg
 - (c) a 9 kg box
 - (d) a ball of mass 0.5 kg
3. Each of the following weights was measured on Earth where the gravitational field strength is approximately 10 N/kg. Calculate the mass of each object.
- (a) a man who weighs 750 N
 - (b) a tin of peas which weighs 4.5 N
 - (c) a chair which weighs 350 N
 - (d) a rabbit which weighs 40 N

4. The mass of a puncture repair kit is 0.03 kg. What is its weight on Earth?
5. Calculate the weight on Earth of a postcard which has a mass of 0.002 kg.

Helpful Hint

Gravitational field strengths for various planets and the Sun and Moon can be found on the data sheet on page 1. The more exact value for the gravitational field strength on Earth is 9.8 Nkg^{-1} . We will use this from now on.

6. What does a 0.5 kg packet of cornflakes weigh:
 - (a) on Earth
 - (b) on the Moon
 - (c) in Space?

7. An astronaut has a weight of 800 N on Earth.
What is his mass:
 - (a) on Earth
 - (b) on the Moon
 - (c) in Space?

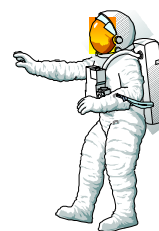

8. A question in a Physics examination asked, 'What is meant by the weight of an object?'
Two pupils, Steven and Nicola, answered as follows :

Steven - 'The weight of an object is the gravitational field strength.'

Nicola - 'The weight of an object is the force acting on the object due to gravity.'

- (a) Who was correct?
 - (b) What does the term 'gravitational field strength' mean?
9. A lift has a weight of 9 000 N on Earth.
 - (a) What force, caused by gravity, acts on the lift?
 - (b) What is the mass of the lift?
10. A rocket of mass $2 \times 10^6 \text{ kg}$ travels from Saturn to Earth.
 - (a) What is the weight of the rocket on Saturn?
 - (b) What is the weight of the rocket on Earth?
11. A paper aeroplane has a mass of 10 g.
 - (a) What is the force, caused by gravity, acting on the paper aeroplane on Earth?
 - (b) What is the gravitational field strength on Earth?
12. A car weighs 13 kN on Earth.
 - (a) What is the mass of the car?
 - (b) What is the downwards force, caused by gravity, on the vehicle on Earth?
13. A small tin of oil has a mass of 300 g.
 - (a) What does the tin of oil weigh on Earth?
 - (b) What would be the mass of the tin of oil on Jupiter?

14. If a man has a weight of 700 N on Earth, what will he weigh on Neptune?
15. A snail has a weight of 0.5 N on Earth. What would be its mass on the Moon?

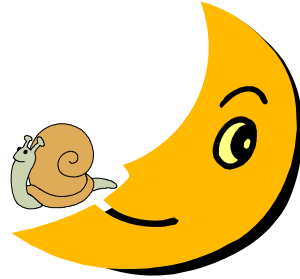

16. If a moon rock has a weight of 4.6 N, what is its mass?
17. Which is heavier, a 2 kg stone on Neptune or a 0.9 kg rock on Jupiter?
18. Find the weight of a satellite booster on Mars if it weighs 24 N on the Moon.
19. What is the difference in **mass** between a 40 N weight on Venus and a 104 N weight on Jupiter?
20. A rock weighs approximately two and a half times its weight on Earth somewhere in our Solar System. Where is it likely to be?

11. "Special Forces"

Friction (National 4)

1. What do two surfaces have to do to create the force called friction?
2. Does friction try to stop surfaces moving, or make the surfaces move faster?
3. Here are 3 pictures of touching surfaces:

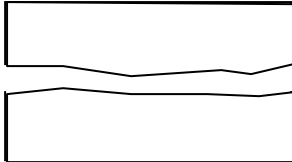

Picture 1.

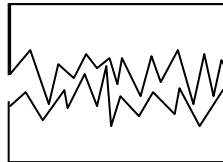

Picture 2.

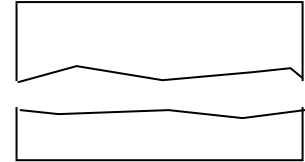

Picture 3.

- (a) Which picture shows the surfaces that would have most friction if you tried to move them over each other.
 - (b) Explain your answer.
4. In these pictures, write down the surfaces which are rubbing together to create friction.

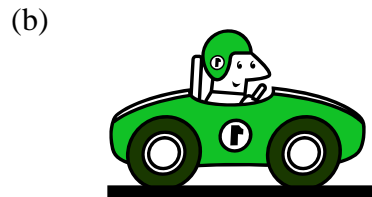

5. Friction is sometimes very useful (good) and sometimes a pain (bad). For each of the following examples, state whether friction is **good** or **bad**.

- (a) Friction between car tyres and the road.
- (b) Friction between your shoes and the ground.
- (c) Friction between skis and snow.
- (d) Friction between a climber's rope and hands.
- (e) Friction between a speed boat and the surface of the water.

6. Friction can be reduced on rough surfaces by **smoothing** or **separating** the surfaces. For each diagram below, state how friction between the surfaces is being reduced.

Diagram A

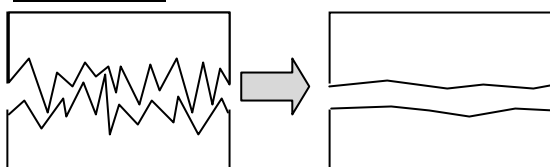
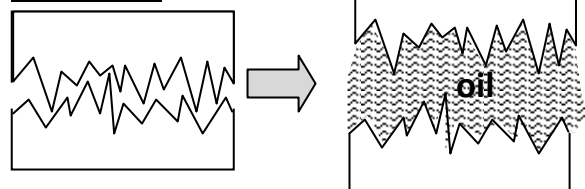

Diagram B



7. A foot in contact with the ground produces a lot of friction. How is an ice skater's boot designed to reduce friction.
8. For each of the following, suggest how friction can be reduced.
- A stiff door hinge.
 - The design of a fast car.
 - Snow boards on snow.
 - An air hockey puck on its table.
9. For the following situations where friction is useful, suggest how friction can be increased.
- Cars sliding on icy roads.
 - Vehicles having to stop at dangerous junctions.
 - Farm vehicle tyres sliding in the mud.
 - A gymnast's hands sliding on the bars.
10. Objects can be “**streamlined**” in order to reduce friction.
- State 3 ways that a vehicle can be streamlined.
 - Describe how a cyclist can make himself streamlined.

Tension and Reaction Forces (National 5)

11. For each of the following situations, state whether the force, **F**, is a **Tension** force or a **Reaction** force.

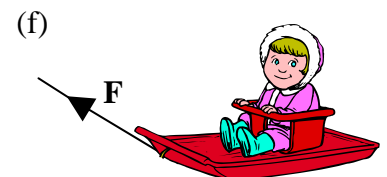
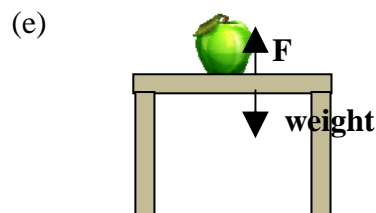
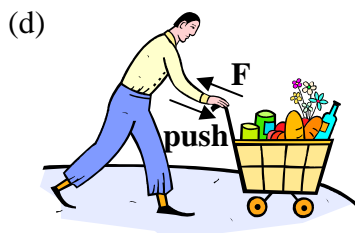
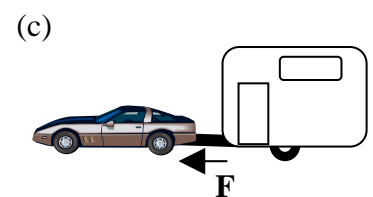
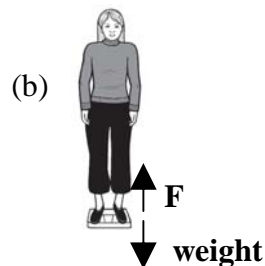
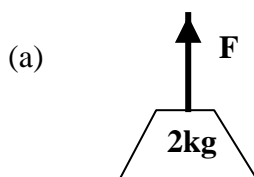

12. **Copy and complete this sentence**

Every force has a _____ force that is equal and opposite to it.

A _____ force is a “pulling force” through a connecting wire or rope or bar.

12. Newton's First Law

National 4

An object will stay at rest or keep moving in a straight line at a constant speed if balanced forces are acting on it.

1. Which of the following diagrams show balanced forces?

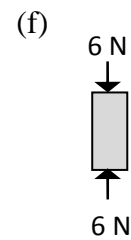
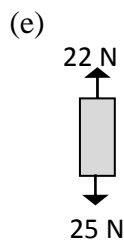
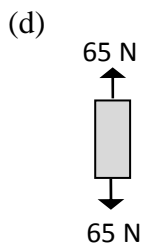
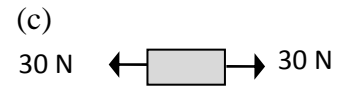
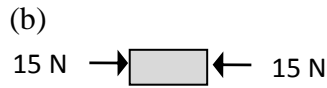
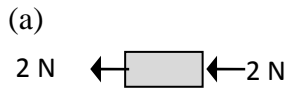

2. A fully loaded oil super-tanker moves at a constant speed of 12 ms^{-1} . Its engines produce a constant forward force of $16\,000 \text{ N}$. What is the size of the friction force acting on the tanker?
3. A clock hangs from a peg on a wall. If the weight of the clock is 2 N what is the size of the upward force provided by the peg?
4. David cycles along the road at a constant speed of 8 ms^{-1} . The total friction force acting on David and the bike is 550 N .

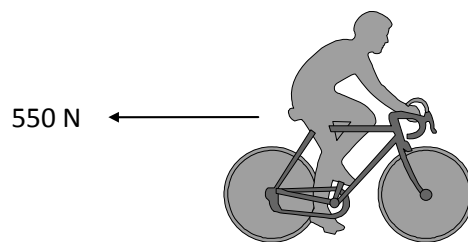

What size is the forward force provided by David pedalling?

5. A crane holds a concrete slab of mass 750 kg at a steady height while workmen prepare to position it on the building they are constructing.
- (a) What is the weight of the concrete slab?
- (b) What is the tension in the crane cable?

6. A helicopter is hovering at a constant height of 35 m. The upward lift force on the helicopter is 85 500 N.

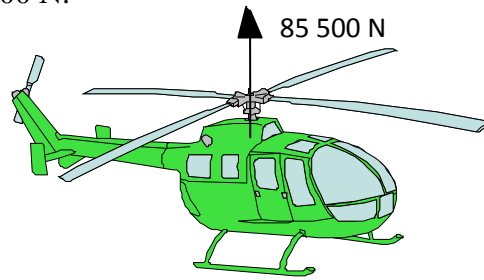

- (a) What is the weight of the helicopter?
 (b) What is the mass of the helicopter?
7. A lift travels upwards at a constant speed of 4 ms^{-1} . The mass of the lift is 800 kg and it is carrying a load which has a mass of 153 kg.
- (a) What is the total mass of the lift and its load?
 (b) What is the total weight of the lift and its load?
 (c) What is the tension in the lift cable as the lift travels upwards?
 (d) What is the tension in the lift cable when it stops at the second floor?
 (e) The maximum tension the lift cable can provide is 16 400 N. What is the greatest mass that the cable can hold?
 (f) If an average person has a mass of 70 kg what is the maximum number of people the lift can carry?
8. In a tug of war the blue team pull the red team with a force of 3 000 N to the left. The two teams remain stationary.

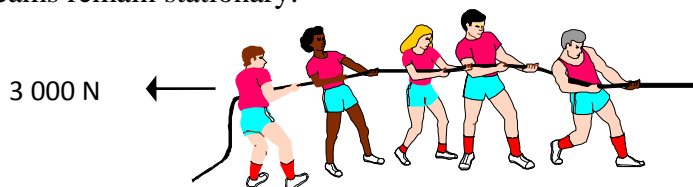

- (a) What is the size and direction of the force exerted by the red team on the blue team?
 (b) Each member of the red team can pull with an average force of 250 N. Calculate how many people there are in the red team.
 (c) One of the members of the red team sprains her ankle and has to leave the competition. What would be the force exerted by the red team now?
 (d) What would happen now?

9. David is doing a parachute jump to raise money for charity. The graph below shows his speed at different points in his journey. Use this graph to answer the questions below.

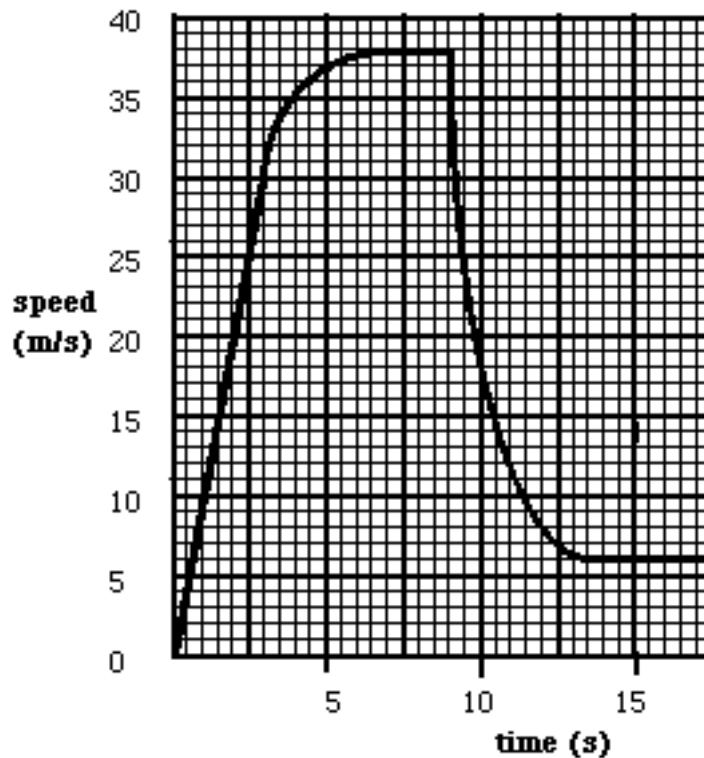

- (a) During what time was David travelling at a constant speed?
- (b) At what time did David open his parachute?
- (c) Describe the forces acting on David 15 seconds after he jumped out of the plane.
- (d) 16 seconds after jumping out of the plane the friction force acting on David was 745 N. Calculate David's mass.
- (e) What would be the size of the friction force acting on David 8 seconds after leaving the plane?
10. An aeroplane travels with a constant speed of 300 ms^{-1} at a height of 10 000 m. The mass of the aeroplane is 58 000 kg and the engine provides a forward force of 2 400 N.
- (a) What size is the frictional force acting on the aeroplane?
- (b) What size is the lift force acting on the plane at this height?

13. Newton's Second Law

National 4 (1 force only) National 5 (more than 1 force)

In this section you can use the equation:

$$\text{Unbalanced force} = \text{mass} \times \text{acceleration}$$

also written as

$$F_u = ma$$

where

F_u = unbalanced force in newtons (N)

m = mass in kilograms (kg)

a = acceleration in metres per second per second (m/s^2 or ms^{-2}).

1. Find the missing values in the following table.

	<i>Force (N)</i>	<i>mass (kg)</i>	<i>acceleration (m/s^2)</i>
(a)		2	4
(b)		6	3
(c)	20	0.2	
(d)	900		10
(e)	28.8		3.5
(f)	450	20	

- Calculate the force required to accelerate a mass of 12 kg at 2 m/s^2 .
- Calculate the force required to accelerate a car of mass 1 000 kg at 5 m/s^2 .
- If a force of 500 N is applied to a mass of 20 kg, calculate its acceleration.
- A man pushes a stacked trolley of mass 25 kg with a force of 25 N. Calculate the acceleration of the trolley.
- Find the mass of a boy and his bike if they accelerate at 1.5 m/s^2 when pushed with a force of 65 N.
- A car on an automatic wash and valet machine is pulled by a force of 500 N and accelerates at 0.25 m/s^2 . What is the mass of the car?
- A fork lift truck applies a force of 2000 N to move a crate of mass 1 700 kg. Calculate the acceleration of the crate.

9. A bus applies a braking force of 2400 N in order to avoid a road accident ahead. The mass of the bus and the people on board is 4 000 kg. Calculate the deceleration of the bus.
10. A table tennis ball of mass 0.03 kg is found to accelerate at 150 m/s^2 when hit with a bat. Calculate the force causing the ball to accelerate.
11. Calculate the acceleration of a steel ball bearing of mass 100 g when fired with a force of 1.5 N in a pin ball machine.
12. A ship of mass $1 \times 10^7 \text{ kg}$ is accelerated by a force of $3.2 \times 10^6 \text{ N}$. Calculate the size of the acceleration.
13. An oil tanker of mass $1.5 \times 10^8 \text{ kg}$ accelerates at 2 ms^{-2} . Calculate the unbalanced force required to cause this acceleration.
14. A 70 kg sledge is pulled along as shown below

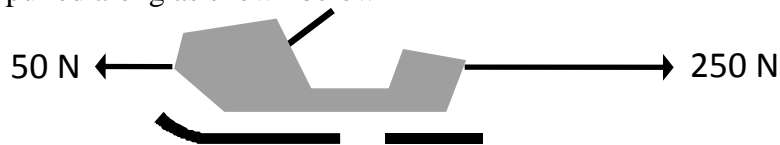

If the frictional forces amount to 50 N, calculate :

- (a) the unbalanced force acting sledge
 - (b) the acceleration of the sledge.
15. The forces acting on a bus are shown below

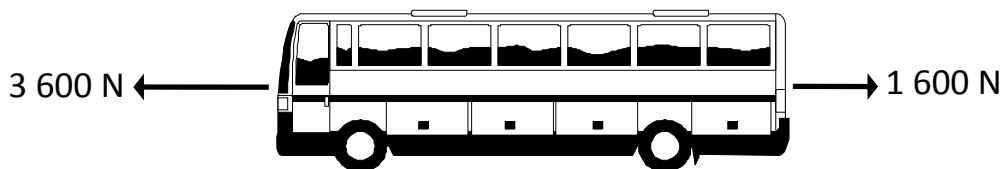

If the total mass of the bus and passengers is 4 500 kg, calculate:

- (a) the unbalanced force acting on the bus
 - (b) the acceleration of the bus.
16. The forces acting on a rocket at launch are as shown below.

Use the information to calculate:

- (a) the mass of the rocket
- (b) the unbalanced force acting on the rocket
- (c) the acceleration of the rocket at lift off.

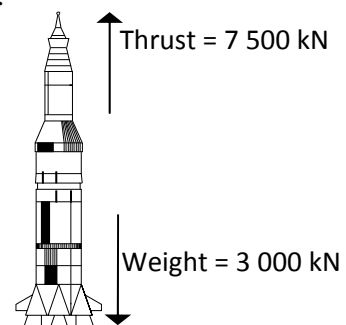

17. A car of mass 1 200 kg is accelerating along a dual carriageway at a constant rate of 3 ms^{-2} .
- Calculate the unbalanced force acting on the car.
 - The engine force is 3 800 N. Calculate the force of friction between the tyres and the road surface.
18. A supermarket assistant is collecting trolleys from the car park to return to the store. He applies a force of 40 N to a set of 15 trolleys as shown below:

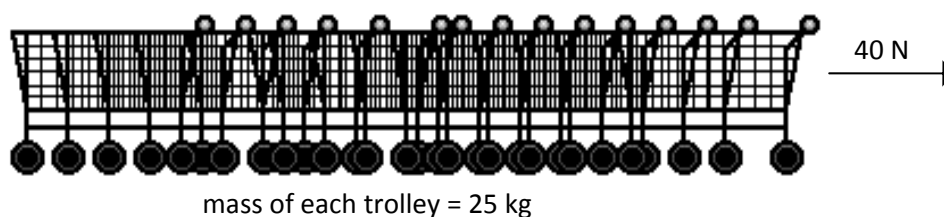

- Calculate the acceleration of the trolleys.
 - If the belt breaks and 5 trolleys become separated calculate the new acceleration of the remaining trolleys. Assume that the assistant continues to apply a force of 40 N.
19. Forces acting on a train of mass 50 000 kg are as shown below.

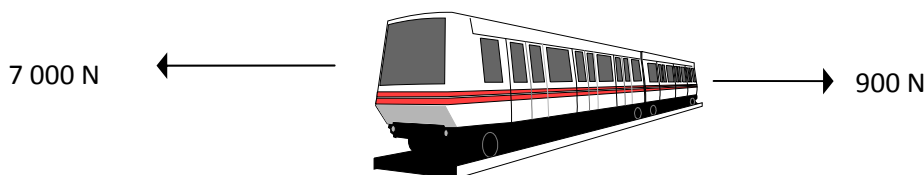

Calculate:

- the unbalanced force acting on the train
 - the acceleration of the train.
20. A car accelerates at 0.6 ms^{-2} when it's engine force is 1000 N and frictional forces against it are 450 N. Find the mass of the car.
21. A car of mass 1 200 kg is accelerated from rest to 8 ms^{-1} in 8 s. Calculate:
- the acceleration of the car
 - the engine force required to produce this acceleration assuming no friction.
22. A 7 500 kg rocket is designed to travel to Mars. The rocket has to reach a speed of 11000 ms^{-1} .
- If the rocket takes 5 minutes to reach this speed, calculate:
- the acceleration of the rocket
 - the unbalanced force acting on the rocket.
 - the engine thrust required to produce this acceleration.
23. A motor cycle is accelerated from rest to 60 ms^{-1} in 16 seconds. If the engine force required to achieve this is 1 200 N, and effects due to friction are ignored, calculate the mass of the motor cycle.

24. A train is travelling through a woodland area when the driver notices a tree on the track. He immediately applies the brakes and manages to slow the train down from 25 ms^{-1} to rest in 6 seconds. If the train has a mass of 60 000 kg calculate the size of the braking force.
25. A bike is pushed from rest to a speed of 3 ms^{-1} in 2.5 seconds. If the mass of the bike and rider are 100 kg calculate the size of the pushing force required.

Helpful Hint

When a spacecraft is **in space** we can ignore gravitational effects so the only force acting on it is its **engine thrust**.

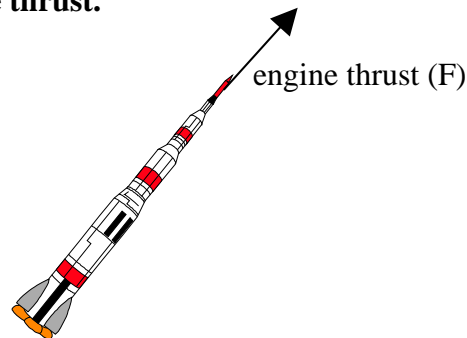

26. The engine of a space shuttle can produce a thrust of 600 000 N. The mass of the shuttle is $8 \times 10^5 \text{ kg}$. Calculate the acceleration of the shuttle in space.
27. What engine thrust must be produced by a rocket of mass $3 \times 10^6 \text{ kg}$ in order to produce an acceleration of 1.4 ms^{-2} in space?

Helpful Hint

To find the **acceleration, a**, of an object during a vertical take-off you will need to calculate the unbalanced force acting on the object first.

Example

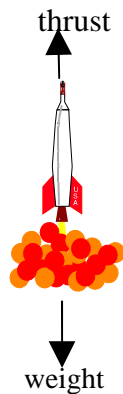

1st. Unbalanced force = thrust - weight

2nd.
$$a = \frac{F_u}{m}$$

(where F_u = unbalanced force)

28. Use the stages outlined in the example above to find the missing values in the following table. Assume that each mass is in the Earth's gravitational field.

	<i>Mass (kg)</i>	<i>Weight (N)</i>	<i>Thrust (N)</i>	<i>Unbalanced force (N)</i>	<i>Acceleration (ms⁻²)</i>
(a)	3	29.4	60		
(b)	200	1 960	21 000		
(c)	1 500		20 000		
(d)	50 000		550 000		
(e)	70 000		840 000		
(f)	76 000		896 800		

29. A water rocket has a mass of 0.8 kg and is launched in a school playground with an initial upwards thrust of 12 N.

- (a) What is the weight of the water rocket in the playground?
- (b) What is the initial acceleration of the rocket in the playground?
- (c) If this water rocket were launched from the Moon, what would be its initial acceleration?
(Remember to find the new weight first !)

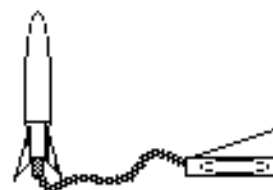

30. A space shuttle has a weight of 1.8×10^7 N on Earth. Its engines produce a thrust of 2.7×10^6 N during part of its journey through space.
(You will need to refer to the data sheet on page 1 for parts of this question.)

- (a) Calculate the mass of the shuttle.
- (b) What is the acceleration of the shuttle in space while its engine thrust is 2.7×10^6 N?
- (c) Could the shuttle have been launched from Earth with this engine thrust of 2.7×10^6 N? Explain your answer.
- (d) The engine thrust was 2.7×10^7 N during the launch from Earth. What was the acceleration of the shuttle during its launch?
- (e) If a similar shuttle was launched from Venus with an engine thrust of 2.7×10^7 N, what would be the acceleration of this shuttle during lift off?
- (f) What engine thrust would be required in order to launch this shuttle from Jupiter with an acceleration of 5 ms^{-2} ?

14. Car Safety

National 5

1. A car is travelling at 30 mph when it collides with a van that came out of a side road. A passenger in the car was not wearing a seatbelt.

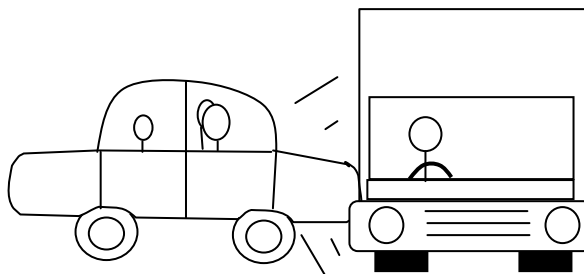

- (a) Describe the likely motion of the passenger from the moment the car hits the van.
- (b) Which law of Physics explains the fact that the passenger did not stop with the car?
- (c) Explain how a seatbelt on the passenger would have acted as a safety device.
2. It is very important that removal lorries secure goods tightly inside the lorry. This is important for moving off as well as for stopping.

The lorry in the picture below contains a cabinet on wheels. The driver decided to put the cabinet at the front of the lorry so it would be held in place when he stopped. That way, he thought, he wouldn't need to bother tying it down.

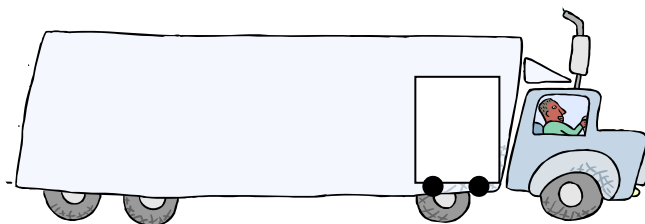

Explain, with reference to Newton's first law, what will happen to the cabinet as the driver accelerates from rest.

3. Air bags are very common features of cars nowadays.
- (a) Explain, in terms of forces, how an air bag can help to protect lives.
- (b) Airbags should be deactivated if young children or babies are sitting in the front seat.
Give a reason for this.

15. Freefall and Terminal Velocity

National 5

1. A skydiver, who has a weight of 650 Newtons, jumps from a plane.

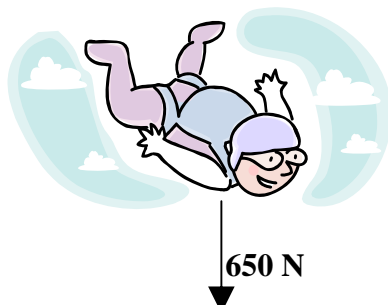

- At the moment she jumps, state the size and direction of the unbalanced force acting on her?
 - At the moment she jumps, how much air resistance acts on her?
 - What happens to her speed, initially, as she falls?
 - How does this affect the air resistance acting on her?
 - Eventually she reaches “terminal” velocity. What can you say about the forces acting on her at this point?
 - When she opens her parachute, which force is affected?
 - Why does she slow down when she opens her parachute?
 - Explain why she eventually reaches a new, lower, terminal velocity.
2. A parachutist jumps out of an aircraft. Sometime later, the parachute is opened.



The graph shows the motion of the parachutist from leaving the aircraft until landing.

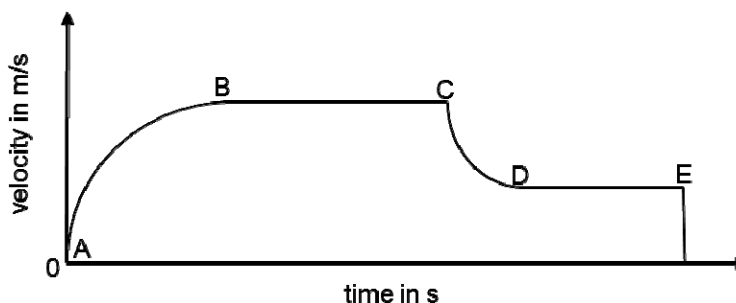

- Which parts of the graph show when the forces acting on the parachutist are balanced?
- Which point on the graph shows the parachute being opened?

3. A car is travelling along a straight road with a constant velocity of 10 ms^{-1} .

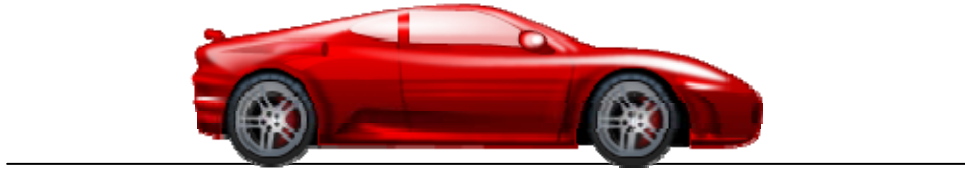

- (a) Identify the two main horizontal forces acting on the car.
- (b) Describe how these forces compare with each other.
- (c) The driver presses the accelerator pedal and the car speeds up. Describe the effect this has on each horizontal force.
- (d) Explain why the car will reach a new “terminal velocity”, with the accelerator in its new position.

16. Newton's Third Law

National 5

1. State Newton's third law.
2. For each of the following "action" forces, state the "reaction" force.

(a)



Action: Golf club exerts forward force on ball.

(b)

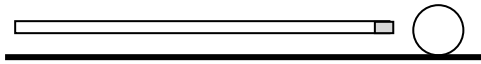

Action: Cue exerts force on ball.

(c)

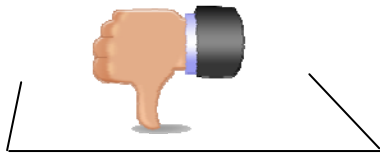

Action: Thumb exerts downwards force on table.

3. Explain why a sniper experiences a force on his shoulder, from his rifle, whenever he fires a shot.
4. An astronaut is carrying out some work on a craft, in space, when the rope attaching him to the spacecraft breaks. The astronaut throws his spanner in a direction away from the space craft.

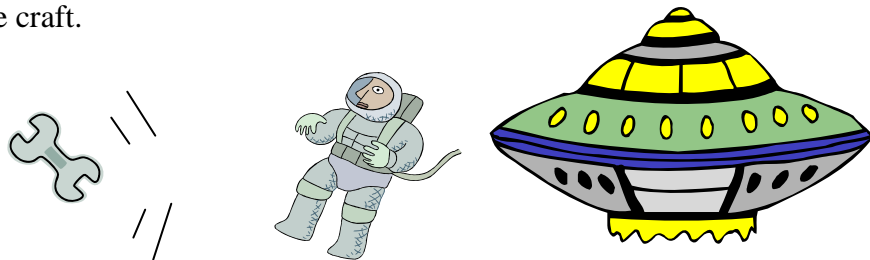

Use Newton's third law to explain why this strange move by the astronaut helps him to return to his space craft.

5. Explain, in terms of the shuttle and the exhaust gases, how a space shuttle is launched.

17. Projectiles

National 5

Helpful Hint

In this section you should remember that the motion of a projectile should be dealt with in separate calculations for its horizontal and vertical paths.

Horizontally Velocity is constant. ($a = 0 \text{ ms}^{-2}$)

$$\bar{v} = \frac{d}{t}$$

where \bar{v} = average horizontal velocity in metres per second (ms^{-1})
 d = horizontal distance travelled in metres (m)
 t = time taken in seconds (s).

Vertically Acceleration is downwards due to gravity. ($a = \text{approx } 10 \text{ ms}^{-2}$ on Earth)

$$a = \frac{v - u}{t}$$

where u = initial vertical velocity in metres per second (ms^{-1})
 v = final vertical velocity in metres per second (ms^{-1})
 a = acceleration due to gravity in metres per second per second (ms^{-2})
 t = time taken in seconds (s).

To calculate the vertical displacement (height) during any projectile journey you must draw a velocity - time graph for the journey and use:

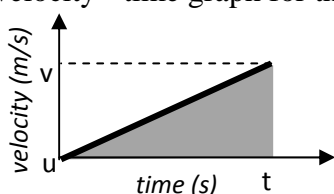

$$\begin{aligned} \text{Height} &= \text{area under velocity - time graph} \\ &= \frac{1}{2} \times \text{base} \times \text{height} \\ &= \frac{1}{2} \times t \times (v - u) \end{aligned}$$

FOR SIMPLICITY use the approximation that gravitational acceleration is 10 ms^{-2} .

1. A stone is kicked horizontally at 20 ms^{-1} from a cliff top and lands in the water below 2 seconds later.

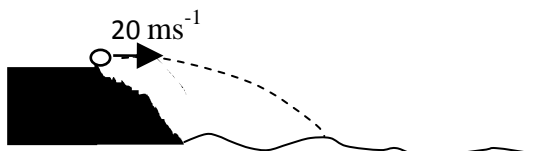

Calculate :

- (a) the **horizontal** distance travelled by the stone
- (b) the final **vertical** velocity
- (c) the vertical height through which the stone drops.

2. A parcel is dropped from a plane and follows a projectile path as shown below. The horizontal velocity of the plane is 100 ms^{-1} and the parcel takes 12 seconds to reach the ground.

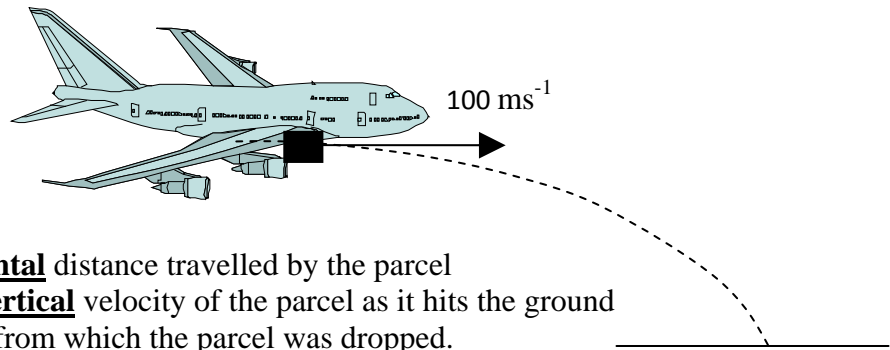

Calculate :

- the **horizontal** distance travelled by the parcel
- the final **vertical** velocity of the parcel as it hits the ground
- the height from which the parcel was dropped.

3. Sand bags are released from a hot air balloon while it is moving horizontally at 30 ms^{-1} . The sand bags land on the ground 10 seconds after they are released.

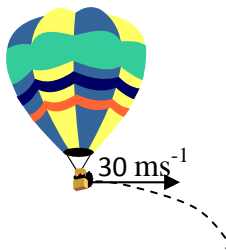

Calculate:

- the **horizontal** distance travelled by the sand bags
- their final **vertical** velocity.

4. A satellite is launched during a practice simulation. The satellite is given a horizontal velocity of $400\,000 \text{ ms}^{-1}$ and 'crashes' 200 seconds later.

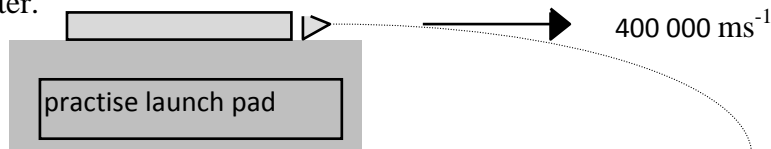

Calculate :

- the horizontal distance travelled by the satellite
- the final vertical velocity of the satellite
- the height from which the satellite was launched.

5. An archer fires an arrow and aims to hit the centre of a target board 50 metres away. The arrow is launched with a horizontal velocity of 100 ms^{-1} , at the same height as the target centre.

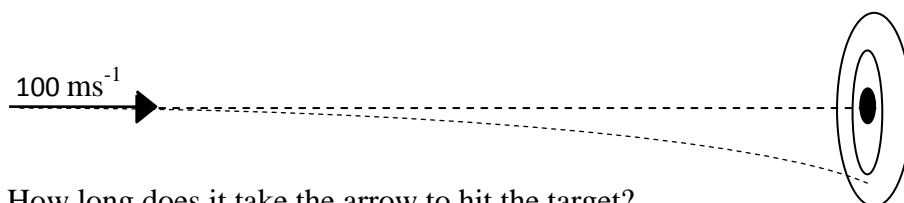

- How long does it take the arrow to hit the target?
- Calculate the final vertical velocity of the arrow.
- By how much does the arrow miss the centre of the target board?

6. A golfer strikes a golf ball and it follows a projectile path as shown below.

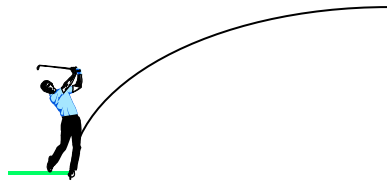

- (a) What is the **vertical** velocity of the ball at its maximum height?
 (b) What is the horizontal velocity of the ball if it takes 4 seconds to travel 400 metres?

7. While on the Moon an astronaut throws a rock upwards and at an angle. The path of the rock is shown below.

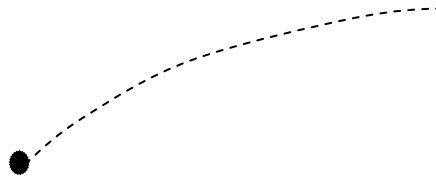

- (a) What is the vertical velocity of the rock at its maximum height?
 (b) How long does the rock take to reach its maximum height if it has an initial vertical velocity of 20 ms^{-1} ?
 (Remember! On the moon $a = 1.6 \text{ ms}^{-2}$)

8. Part of the space flight of a shuttle is represented in the velocity time graphs below.

Horizontal motion

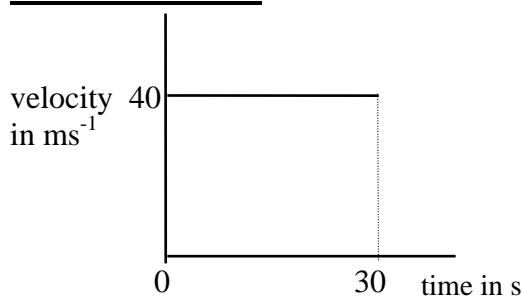

Vertical motion

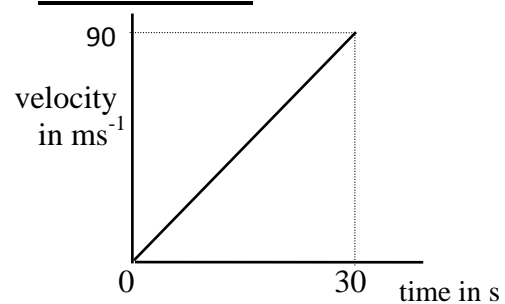

Use the graphs to find out how far the shuttle travels both horizontally and vertically in the 30 second journey.

9. During take off from Mars one of the boosters on a rocket fails causing the rocket to follow a projectile path rather than a vertical one.
The speed time graphs for a 20 second interval immediately after the booster failed are shown below.

Horizontal motion

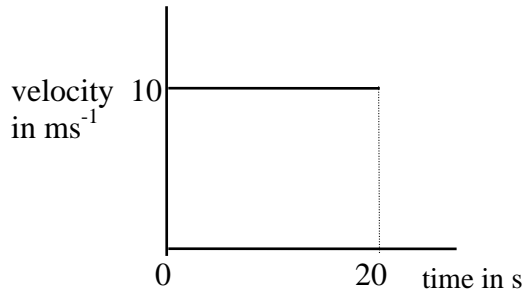

Vertical motion

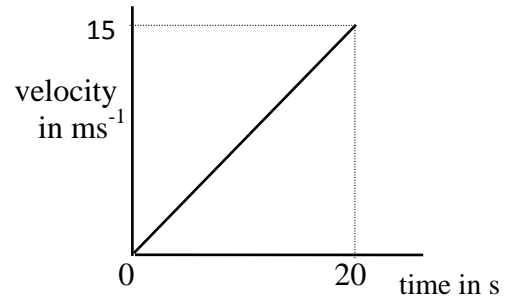

Use the graphs to calculate:

- the horizontal distance travelled during take off
 - the acceleration in the vertical direction during the first 20 seconds
 - the vertical distance travelled.
10. A stunt motor cyclist tries to beat the record for riding over double decker buses. He leaves the start position with a horizontal velocity of 35 ms^{-1} and lands 2.4 seconds later.

Calculate :

- the horizontal distance travelled by the cyclist
- the final vertical velocity of the motor cycle as it touches the ground
- the height of the platform.

18. Satellites

National 4 and National 5

In this section you can use the two equations which you have met previously in the “Waves and Radiation” unit:

$$v = f \lambda$$

$$v = \frac{d}{t}$$

Where v = average wave speed in metres per second (m/s or ms^{-1})
 f = frequency in hertz (Hz)
 λ = wavelength in metres (m)
 d = distance in metres (m)
 t = time in seconds (s)

Helpful Hint

Radio waves, television waves and microwaves are all electromagnetic waves which travel at a speed of 3×10^8 m/s ($3\,00\,000\,000 \text{ ms}^{-1}$) through space.

- To communicate with satellites high above the Earth, microwaves are used. Microwaves are electromagnetic waves with very high frequencies, usually measured in giga hertz (GHz). Convert each of the following microwave frequencies into hertz.
(a) 4 GHz (b) 11 GHz (c) 14 GHz (d) 6.5 GHz
- A telecommunication satellite is in an orbit 20 000 **km** above the surface of the earth. A microwave of frequency 6 **GHz** is used to send a signal from a ground station to the satellite. Calculate:
(a) the wavelength of the microwave
(b) how long it would take the signal to travel 20 000 km.
- In 1964, SYNCOM, the world’s first experimental geostationary satellite was launched into a 36 000 km orbit. A microwave of wavelength 2 cm could be used to communicate with the satellite in its geostationary orbit.

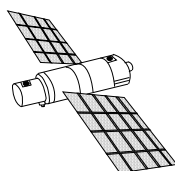

- Calculate the frequency of microwaves which have a wavelength of 2 cm.
- How long would it take a microwave to travel 36 000 km?

4. A dish aerial is used to transmit a 25 cm microwave signal to a spy satellite directly overhead.
- Calculate the frequency of the signal.
 - How long will it take this signal to travel 20 000 km up to the satellite?
5. A dish aerial at a ground station collects a 12 GHz signal transmitted by a satellite. The signal took 0.15 s to reach the aerial.
- What is the wavelength of this signal?
 - How far away is the satellite from the ground station?
6. In 1962 the communications satellite Telstar was used to relay the first live television pictures from the east coast of the U.S.A to Britain. Telstar orbited the earth at a height varying from 320 km to 480 km.

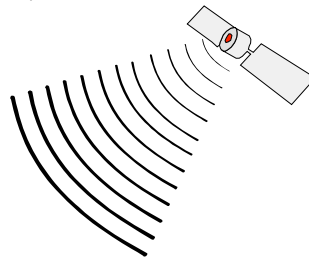

Calculate how long it would take for a 3 cm microwave signal to travel to the satellite if it was 320 km above the transmitter.

7. One of the first explorer satellites had an orbit height of 4 000 km above the surface of the Earth. Another satellite, Early bird, had an orbit height of 36 000 km. Which satellite took longer to make one complete orbit of the Earth?
8. The communications satellite INTELSAT V was launched into a geostationary orbit in 1980. It could handle 12 000 telephone calls plus two TV channels at the same time using microwave frequencies of 4 GHz , 6 GHz, 11 GHz and 14 GHz.
- How long did INTELSAT V take to make one complete orbit of the Earth?
 - Calculate the longest wavelength of signal used to communicate with the satellite.
9. A satellite in a geostationary orbit 36 000 km above the surface of the Earth receives a 3 cm microwave signal from the ground station. A second microwave signal with the same wavelength is sent to a satellite in a much lower orbit.
- Calculate the frequency of the 3 cm signal.
 - It takes 0.05 seconds for the signal to reach the lower satellite. Calculate the orbit height of this satellite.

10. A satellite is used to send a TV signal from Britain to the USA. The TV signal from Britain is sent to the satellite on a microwave carrier wave of frequency 14 GHz. At the satellite the signal is amplified and relayed to the USA on a carrier wave of frequency 11 GHz.

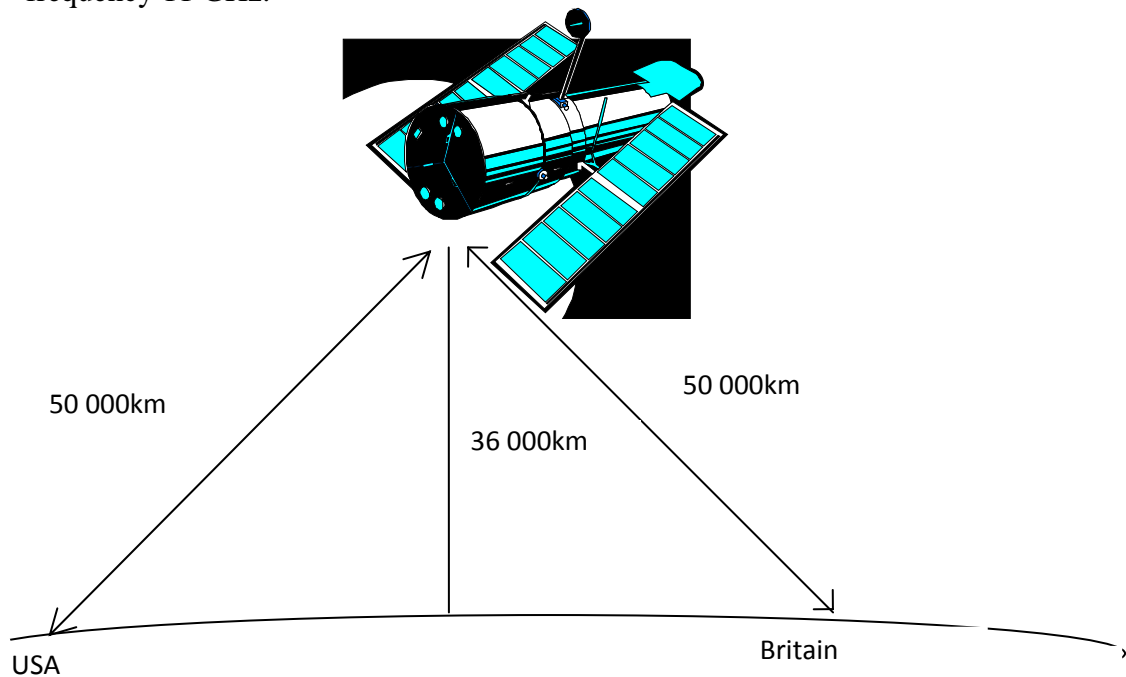

- Calculate the wavelength of the wave transmitted from Britain to the satellite.
- Calculate how long it takes the signal to travel from Britain to the satellite.
- What is the wavelength of the signal sent from the satellite to the USA?
- How long will it take for the TV signal to reach the USA from Britain?
(Assume that the time taken to amplify the signal at the satellite before relaying it is so small that it can be ignored.)

19. Work Done

National 5

In this section you can use the equation:

$$\text{work done} = \text{force} \times \text{distance}$$

also written as

$$E_w = F d$$

where E_w = work done in joules (J)
 F = force in newtons (N)
 d = distance in metres (m).

1. Find the missing values in the following table.

	<i>Force (N)</i>	<i>Distance (m)</i>	<i>Work Done (J)</i>
(a)	150	25	
(b)	6 500	320	
(c)		52	6 500
(d)	2		542

2. A gardener pushes a wheelbarrow with a force of 250 N over a distance of 20 m. Calculate how much work he does.
3. Fiona pushes a pram with a force of 150 N. If she does 30 000 J of work calculate how far she pushes the pram.
4. Joseph pulls his sledge to the top of a hill. He does 1 500 joules of work and pulls the sledge a distance of 50 metres. With what force does he pull the sledge?
5. A horse pulls a cart 3000 m along a road. The horse does 400 000J of work. What force does the horse exert on the cart?
6. A car tows a caravan with a constant force of 2 500 N over part of its journey. If the car does 8 500 000 J of work calculate how far it pulls the caravan.
7. During a race a motorcycle engine produced a steady forward force of 130 N. Calculate the work done by the engine if the motorcycle covered a distance of 50 000m.
8. A motor boat tows a yacht out of a harbour. If the motor boat exerted a force of 110 000N and did 200 000 000 J of work calculate how far it towed the yacht.

9. A locomotive exerts a force of 15 kN on a train of carriages. The locomotive pulls the train over a distance of 5 km. Calculate the work done by the locomotive.
10. On an expedition to the North Pole, Husky dogs were used to pull the sledges carrying supplies for the journey. One team of dogs did 650 MJ of work during the 1 500 km journey.
- Calculate the average force that the team of dogs exerted on the sledge.
 - There are 8 dogs in a team. Calculate the average force exerted by each dog during the journey.
11. How far can a milk float travel if the electric engine produces a steady force of 2 kN and does 9 500 kJ of work before the battery needs recharged?
12. Peter and John work at a supermarket. They are responsible for collecting trolleys from the trolley parks in the car park and returning them to the store.
- Peter collects trolleys from the furthest trolley park. He has to pull them 150 m back to the store and collects 10 trolleys at a time. If Peter pulls the 10 trolleys together with an average force of 350 N calculate how much work he does in one journey.
 - John does not have so far to walk so he collects 20 trolleys at a time. He pulls his trolleys with an average force of 525 N and covers 100 m each journey. Calculate how much work he does in one trip.
 - Each boy has to return 80 trolleys to the store before finishing their shift.
 - Calculate how many journeys each boy has to make.
 - Show by calculation who does the most work.

Helpful Hint

Special case

When work is done **lifting** an object at a steady speed, the force required is equal to the **weight** of the object .

So ... $\text{Work done} = \text{weight} \times \text{height}$

13. A painter is painting the ceiling of a room. She fills her tray with paint and lifts it up the ladder. The weight of the full paint tray is 30 newtons and she lifts it through a height of 2 m. Calculate the amount of work she does.
14. Marco climbs a rope in the school gym during his P.E. lesson. He weighs 600 N and climbs 8 m up the rope at a steady speed. Calculate how much work he does.



15. A chair lift carries two skiers and their equipment to the top of a ski run which is at a height of 300 m. The chair lift weighs 500 N and the skiers with their equipment weigh 1 800 N. Calculate the work done by the chair lift motor in lifting the skiers to the top of the ski run.

16. A crane lifts a concrete block through a height of 40 m. The crane does 650 kJ of work.

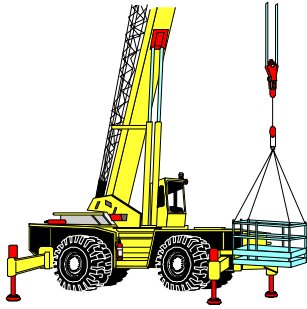

Calculate:

- (a) the weight of the concrete block
(b) the mass of the concrete block.
17. A librarian is placing books on to the fiction shelf which is 2 metres from the ground. He does 80 joules of work lifting the books from the floor to the shelf.
- (a) Calculate the weight of the books.
(b) What is the mass of the books?
(c) If each book has an average mass of 400 g calculate how many books the librarian places on the shelf.
18. A search and rescue helicopter is called to a ship in the North Sea to airlift an injured sailor to hospital. The helicopter lifts the sailor 150 m at a constant speed of 4 m/s . The sailor has a mass of 75 kg.

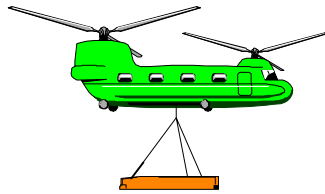

Calculate

- (a) the weight of the sailor
(b) the work done by the helicopter during this lifting operation.

20. Kinetic Energy

National 5 – Officially “Electricity & Energy” unit but relevant to “Dynamics & Space”

In this section you can use the equation:

$$\text{kinetic energy} = \frac{1}{2} \times \text{mass} \times \text{velocity}^2$$

also written as

$$E_k = \frac{1}{2} m v^2$$

where E_k = kinetic energy in joules (J)
 m = mass in kilograms (kg)
 v = velocity in metres per second (ms^{-1}).

1. Find the missing values in the following table.

	<i>Mass (kg)</i>	<i>Velocity (ms^{-1})</i>	<i>Kinetic energy (J)</i>
(a)	2.0	3.0	
(b)	0.5	15.0	
(c)	4.5	4.0	
(d)	4.0	5.0	
(e)	0.24	10.0	
(f)	20.0	200.0	

2. Calculate the kinetic energy of a car travelling at 15 ms^{-1} if the car has a mass of 1 200 kg.
3. A ball, which has a mass of 0.5 kg, rolls down a hill. What is its kinetic energy at the foot of the hill if its velocity is 3 ms^{-1} ?
4. A mass of 2 kg falls from a table and has a velocity of 4.4 ms^{-1} just before it hits the ground. How much kinetic energy does it have at this point?
5. A bus, travelling at a constant velocity of 10 ms^{-1} , accelerated to 24 ms^{-1} . If the bus had a mass of 5 000 kg, calculate :
- (a) the kinetic energy of the bus before it accelerated
- (b) the kinetic energy of the bus at its new velocity.
6. A long distance runner has a mass of 70 kg. If he crosses the finishing line with a velocity of 5.4 ms^{-1} , how much kinetic energy does he have at the finishing line?

7. The mass of an electron is 9.11×10^{-31} kg. What is the kinetic energy of an electron which is travelling with a velocity of 2×10^7 ms^{-1} ?
8. A 50 000 kg train is travelling at 72 kmh^{-1} .
(72 km = 72 000 m, 1 hour = 3600 s)
- (a) What is its velocity in ms^{-1} ?
- (b) How much kinetic energy does the train have?
9. A tortoise is moving along the ground with a velocity of 5 cm s^{-1} . If its mass is 3 kg, how much kinetic energy does it have?

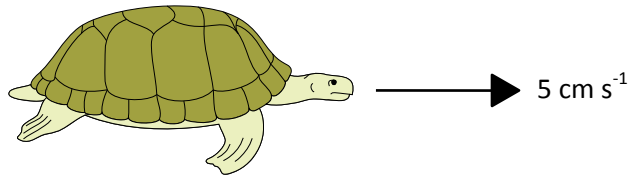

10. The graph below shows how the velocity, in km s^{-1} , of a space capsule decreased as the capsule re-entered the Earth's atmosphere.

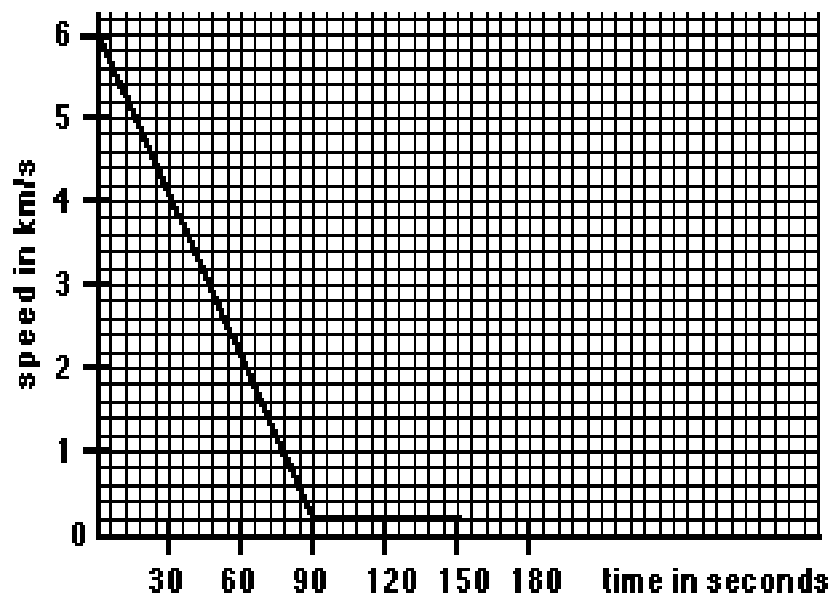

If the space capsule had a mass of 4 500 kg, how much kinetic energy did it **lose** as it re-entered the Earth's atmosphere?

11. What is the velocity of a ball which has 114 J of kinetic energy and a mass of 2.28 kg?
12. Find the mass of an apple given that the apple is rolling along a table at 0.8 ms^{-1} and has 0.04 J of kinetic energy.



13. Calculate the velocity of a taxi which has a mass of 1500 kg and 363 kJ of kinetic energy.

14.

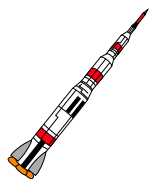

A space capsule travelling at 5 km s^{-1} has $6 \times 10^{10} \text{ J}$ of kinetic energy.

- (a) What is the velocity of the capsule in ms^{-1} ?
- (b) What is the mass of the capsule?

15. A motor cycle and a $5\,000 \text{ kg}$ bus have equal amounts of kinetic energy. The motor cycle is travelling at 35 ms^{-1} and has a mass, including rider, of 370 kg .

- (a) How much kinetic energy does the motorcycle have?
- (b) Calculate the velocity of the bus.

16. A trolley rolls down a ramp which is 80 cm long. It passes through a light gate near the bottom of the ramp and the timer records a time of 0.19 s for the trolley to cut the light beam.

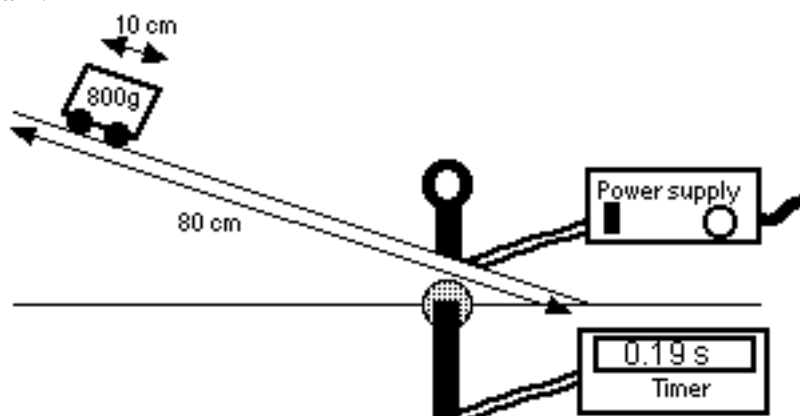

The mass of the trolley is 800 g and it has a length of 10 cm .

- (a) What is the speed of the trolley as it passes through the light gate?
- (b) How much kinetic energy does it have as it passes through the light gate?

17. A hospital lift has a mass of 800 kg when empty. On one occasion the lift, carrying passengers, rises with a speed of 1.5 ms^{-1} and has $1\,215 \text{ J}$ of kinetic energy. How many people were in the lift on this occasion?

(Assume that each person has a mass of 70 kg)

18. A minibus of mass $2\,800 \text{ kg}$ was travelling with a speed of 10 ms^{-1} . It then accelerated at a rate of 0.8 ms^{-2} for 10 seconds .

- (a) What was the kinetic energy of the minibus while it was travelling at 10 ms^{-1} ?
- (b) What was the speed of the minibus after 10 seconds of acceleration? (**uvat!**)
- (c) How much kinetic energy did the minibus gain during the acceleration period?

21. Potential Energy

National 5 – Officially “Electricity & Energy” unit but relevant to “Dynamics & Space”

In this section you can use the equation:

$$\text{potential energy} = \text{mass} \times \text{gravitational field strength} \times \text{height}$$

also written as

$$E_p = m g h$$

where

- E_p = potential energy in Joules (J)
 m = mass in kilograms (kg)
 g = gravitational field strength in newtons per kilogram (Nkg^{-1})
 h = height in metres (m).

1. Find the missing values in the following table.

	<i>Mass (kg)</i>	<i>Gravitational Field Strength (Nkg^{-1})</i>	<i>Height (m)</i>	<i>Potential Energy (J)</i>
(a)	25	9.8	15	
(b)	30	9.8	45	
(c)	35	9.8		450
(d)	2	9.8		70
(e)		9.8	5	120
(f)		9.8	57	6000

2. Calculate the gravitational potential energy gained when:
- a crate of mass 20 kg is lifted up 12 m
 - an injured climber of mass 75 kg is raised through a height of 200 m
 - a pile of bricks of mass 15 kg is hoisted up 25 m.
3. Calculate the mass of a loaded crate which:
- gains 200 J of gravitational potential energy when lifted up 15 m
 - loses 2 000 J of gravitational potential energy when dropped 26 m
 - loses 1 500 J of gravitational potential energy when dropped 8 m.
4. Calculate the height climbed by a 60 kg window cleaner if he gains 1 800 J of gravitational potential energy by climbing up his ladder.
5. A pot holer of weight 70 kg climbs 60 m. How much potential energy does he gain?
6. A car containing 4 passengers has a total mass of 1 200 kg. How much potential energy does it lose as it travels down a 40 m high slope?

7. Calculate the mass of a skier if he loses 78 000 J of potential energy when skiing down a slope of 120 m.

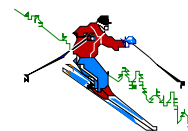

8. Calculate the potential energy gained by a ping pong ball lifted to a height of 2m if it has a mass of 30 g.
9. Water in the reservoir of a hydroelectric power station 'holds' 120 MJ of potential energy. The mass of water is 120 tonnes (**1 tonne = 1 000 kg**). Calculate the height of the stored water.
10. A mountain rescuer is trying to rescue a group of climbers stranded on a ledge 250 m above ground level. The only way to reach the climbers is to climb down to them from another ledge 440 m above ground level. If the mountain rescuer has a mass of 85 kg calculate:
- (a) the potential energy gained initially by climbing to the higher ledge
 - (b) the amount of potential energy he **loses** as he climbs to the lower ledge.

Helpful Hint

If a question gives you the weight of an object and asks you to calculate the potential energy, you can use

$$E_p = (mg) \times \text{height}$$

$$E_p = \text{weight} \times \text{height} \quad (\text{Since weight} = mg)$$

11. Calculate the potential energy lost by a person of weight 500 N who jumps from a wall 2 m high.
12. Calculate the potential energy lost by a lift which descends through 50 metres. The total weight of lift plus passengers is 10 800 N.
13. During a sponsored 'stretcher lift' a group of students lift a stretcher plus patient 120 metres up a hill. If the total weight of the patient and the stretcher is 1 000 N, calculate the amount of potential energy they gain.



14. Calculate the maximum height of a fun ride in which the passengers lose 8 500 J of energy as their carriage drops through the maximum height. The passengers and the carriage have a combined weight of 400 N
15. Calculate the weight of a pile of bricks if they gain 2 000 J of energy as they are lifted up 20 metres.

22. Space Exploration

National 4 and National 5

1. Traditional telescopes based on Earth (terrestrial telescopes) detect light. What other type of signal can telescopes on Earth detect?
2. Terrestrial telescopes are limited because they cannot detect many radiations from space. Telescopes in orbit above our atmosphere can gather much more information about other parts of our galaxy and beyond.
 - (a) Why are terrestrial telescopes unable to detect some types of radiation from space?
 - (b) Name one space telescope currently in orbit around Earth.
3. “Unmanned missions” often involve space probes being sent very long distances. On February 17, 1998, space probe Voyager 1 became the most distant human-made object in space.
 - (a) When was Voyager 1 launched?
 - (b) Use the internet to find out where Voyager 1 and Voyager 2 are today.
4. Space exploration has required the development of various new technologies. Some of these technologies have resulted in “spin off” developments for domestic use. Give 3 examples of items we commonly use that were originally developed for use in space exploration.
5. What is meant by the term “geostationary satellite”?
6.
 - (a) What is meant by the term “period” when referring to satellite orbits?
 - (b) How does a satellite’s height above Earth affect its period?
7. Explain why satellites are useful for defence and security.
8. Explain why satellites are useful for communications.
9. Apart from communications and defence, state 3 other uses of satellites.
10. Why does re-entry to a planet’s atmosphere pose a challenge to space craft designers and engineers?

23. Specific Heat Capacity

National 5

In this section you can use the equation:

$$\text{heat energy} = \text{specific heat capacity} \times \text{mass} \times \text{temperature change}$$

also written as

$$E_h = c m \Delta T$$

Where E_h = heat energy in joules (J)
 c = specific heat capacity in joules per kilogram per degree Celsius ($\text{Jkg}^{-1} \text{ } ^\circ\text{C}^{-1}$)
 m = mass in kilograms (kg)
 ΔT = change in temperature ($^\circ\text{C}$).

Helpful Hint

You will need to look up values for the specific heat capacity of different materials. These values can be found on the data sheet on page 1.

1. Find the missing values in the following table.

	<i>Heat energy</i> (J)	<i>Specific heat capacity</i> ($\text{Jkg}^{-1} \text{ } ^\circ\text{C}^{-1}$)	<i>Mass</i> (kg)	<i>Temperature change</i> ($^\circ\text{C}$)
(a)		4 200	2	65
(b)		902	5.5	15
(c)	2.4×10^3	386	1.6	
(d)	4 250		17	0.5
(e)	1.6×10^3		1.5	2
(f)		128	50×10^{-3}	30

2. How much heat energy is required to raise the temperature of 3 kg of aluminium by 10°C ?
3. 3 kJ of heat is supplied to a 4 kg block of lead. What would be the rise in temperature of the block?
4. In an experiment on specific heat capacity an electric heater supplied 14 475 J of heat energy to a block of copper and raised its temperature by 15°C . What mass of copper was used in the experiment?

5. 6900 J of heat is supplied to 0.5 kg of methylated spirit in a plastic beaker and raises its temperature by 1.5°C. What is the specific heat capacity of methylated spirit?
6. How much heat energy would be required to raise the temperature of 2 kg of alcohol from 20°C to 65°C?
7. A 0.25 kg block of copper is allowed to cool down from 80°C to 42°C. How much heat energy will it give out?
8. 254 400 J of energy are required to heat 2 kg of glycerol from 12 °C to 65 °C . What is the specific heat capacity of glycerol?
9. Which of the following would give out more heat energy:
 A - a 2 kg block of aluminium as it cools from 54 °C to 20°C
 or
 B - a 4 kg block of copper as it cools from 83°C to 40°C ?
10. 2500 J of heat is supplied to a quantity of alcohol and raises its temperature from 22°C to 45°C . What mass of alcohol was being heated?
11. Each concrete block in a storage heater has a mass of 1.4 kg. The blocks are heated to 85°C at night when the electricity is cheaper and cool down during the day to 20°C . If each block releases 77 000 J of energy during the day calculate the specific heat capacity of the concrete.
12. An immersion heater is used to heat 30 kg of water at 12°C. The immersion heater supplies 8 600 000 J of heat. Ignoring heat losses to the surroundings calculate the final temperature of the water.
13. A kettle supplies 262 **kJ** of energy to 800 **g** of water in order to heat it to 90 °C . What was the temperature of the water before the kettle was switched on?

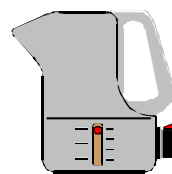

14.



A cup containing 140 **g** of water is heated in a microwave oven. The microwave supplies 4.9×10^4 J of heat to the water which was originally at 10°C.
 What is the final temperature of the water?

15. A 400 **g** block of lead is heated to 45°C by an electric heater which supplies 1.2 **kJ** of heat. What was the initial temperature of the lead block?

24. Specific Latent Heat

National 5

In this section you can use the equation:

$$\text{heat energy} = \text{mass} \times \text{specific latent heat}$$

also written as

$$E_h = m L$$

where

E_h	=	heat energy in joules (J)
m	=	mass in kilograms (kg)
L	=	specific latent heat in joules per kilogram (J kg^{-1}).

Helpful Hint

Value for 'L' described above can be found in the data sheet on page 1.

When you are solving a problem using this formula it is important to use the **correct value of 'L'** from the data sheet.

To do this:

Read the question carefully.

If the question is about the change of state: **liquid to gas** or **gas to liquid**
then

'L' = latent heat of vaporisation

If the question is about the change of state : **liquid to solid** or **solid to liquid**
then

'L' = latent heat of fusion.

1. Find the missing values in the following table.

	<i>Energy (J)</i>	<i>Mass (kg)</i>	<i>Specific latent heat (J kg^{-1})</i>
(a)		2.0	0.99×10^5
(b)		35.5	8.3×10^5
(c)	1.08×10^6	6.0	
(d)	4.032×10^5		11.2×10^5
(e)	22.6×10^5		22.6×10^5
(f)	1.837×10^8	550	

2. Calculate the heat energy released when 2 kg of ice melts into 2 kg of water without a change in temperature.

3. How much heat energy is released when 56 kg liquid carbon dioxide changes into solid form without a change in temperature?
4. What mass of steam is produced when 7 232 000 J is supplied to water at 100°C?
5. What mass of turpentine condenses when 168 200 J of heat energy is removed from a supply of gaseous turpentine at its boiling point?
6. Calculate the specific latent heat of fusion of aluminium given that 10·27 **MJ** is required to change 26 kg of it from molten form into solid form.
7. How much heat energy is required to change 40 kg of solid carbon dioxide into liquid form with no change in temperature?
8. How much heat energy is required to evaporate 0.6 kg of water at 100 °C ?
9. The melting point of a certain chemical substance is 137°C. How much heat is required to melt 0.7 kg of this substance if it is known to have a specific latent heat of fusion of 1 300 J kg⁻¹?
10. How much water would evaporate at 100 °C if you supplied it with 28 500 J of heat energy?
11. Liquid alcohol vaporises when used to make flambees. Calculate the heat energy required to change 0.5 kg of liquid alcohol into its gaseous form without a change in temperature.
12. Calculate the specific latent heat of fusion of lead if it takes 500 000 J of heat to convert 20 kg of solid lead into molten form at its melting point.
13. What mass of liquid glycerol is converted to vapour when 8 300 000 J of heat energy is supplied to it at its boiling point?
14. A steam wallpaper stripper can be used to help with the tedious task of preparing walls before decorating. The stripper contains 15 kg of water which turns to steam when boiled. Assuming the stripper is 100 % efficient, how much boiling water is converted to steam, if 100×10^5 J of energy is supplied to it?

15. During an experiment 0.02 kg of steam was converted to ice. The temperature was recorded at various times throughout the experiment and plotted on a graph. The graph of results is shown below.

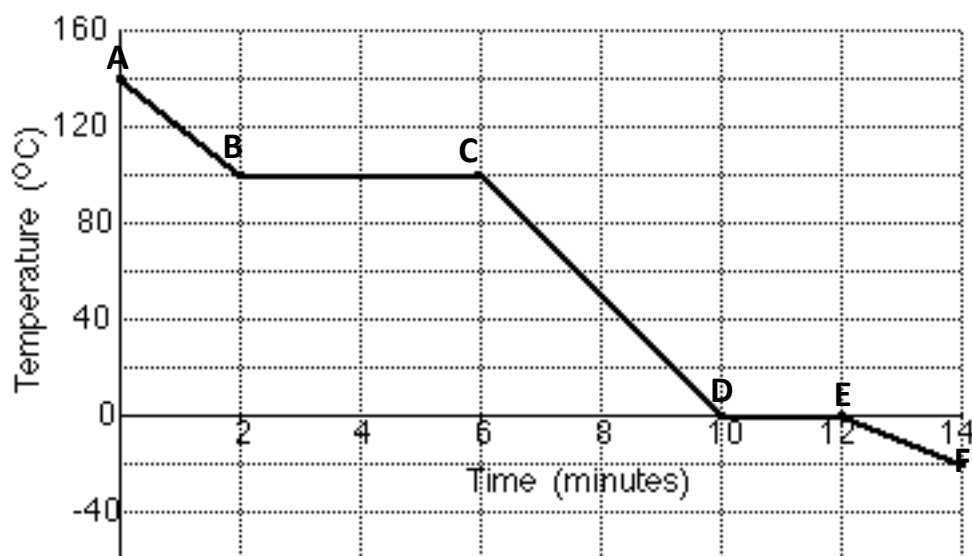

- (a) Between which 2 letters on the graph is the steam changing to water?
- (b) How much heat energy does the steam lose at 100 °C to become water at 100 °C?
- (c) How much heat energy does the water lose at 100 °C to become water at 0 °C?
- (d) How much heat energy does the water at 0 °C lose to become ice?

25. Re-Entry

National 5

In this section you can use the following equations:

$$E_k = \frac{1}{2} m v^2$$
$$E_h = c m \Delta T$$
$$E_h = m L$$
$$E_w = F d$$

Where	E_k	=	kinetic energy (J)
	E_h	=	heat energy (J)
	E_w	=	work done (J)
	m	=	mass (kg)
	v	=	velocity (ms^{-1})
	c	=	specific heat capacity ($\text{J kg}^{-1} \text{ }^\circ\text{C}^{-1}$)
	L	=	specific latent heat (J kg^{-1})
	ΔT	=	change in temperature ($^\circ\text{C}$)
	F	=	force (N)
	d	=	distance (m).

Helpful Hint

Energy cannot be created or destroyed. It can be changed from one form into another. When an object re-enters the Earth's atmosphere it heats up. **Some or all of its kinetic energy changes to heat energy as work is done against friction.** The shuttle has heat resistant tiles covering its body to stop it burning up as it re-enters the atmosphere.

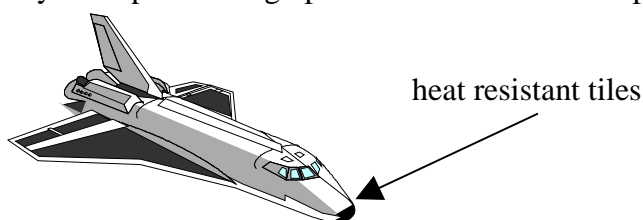

In order to stop the shuttle when it touches down, work must be done by frictional forces. This changes its kinetic energy into heat energy.

1. A small piece of metal of mass 2 kg falls from a satellite and re-enters the Earth's atmosphere at a velocity of $4\,000 \text{ ms}^{-1}$. If all its kinetic energy changes to heat calculate how much heat is produced.
2. How much work must be done by the brakes on a shuttle of mass $2 \times 10^6 \text{ kg}$ to bring it to rest if it lands with a touch down velocity of 90 ms^{-1} ?

3. The space shuttle Columbia re-entered the Earth's atmosphere at a speed of $8\,000\text{ ms}^{-1}$ and slowed down to a speed of 200 ms^{-1} . The shuttle's mass was $2 \times 10^6\text{ kg}$.
- (a) How much kinetic energy did the shuttle lose?
 (b) How much heat energy was produced during this process?
4. A 'shooting star' is a meteoroid that enters the Earth's atmosphere and is heated by the force of friction which causes it to glow. A certain meteoroid has a mass of 30 kg and enters the atmosphere at a velocity of $4\,000\text{ ms}^{-1}$.

Calculate the heat energy produced if all of the meteoroid's kinetic energy is converted to heat.

5. A small spy satellite of mass 70 kg is constructed from a metal alloy. The satellite has a short lifetime of two weeks before it re-enters the Earth's atmosphere at a speed of $5\,000\text{ ms}^{-1}$.

Calculate how much heat energy is produced when all of the satellite's kinetic energy changes to heat energy.

6. The nose section of a shuttle is covered with 250 kg of heat resistant tiles which experience a rise in temperature of $1\,400\text{ }^\circ\text{C}$ during the shuttle's journey back through the Earth's atmosphere. The shuttle is slowed from $2\,250\text{ ms}^{-1}$ to 100 ms^{-1} during this part of the journey.

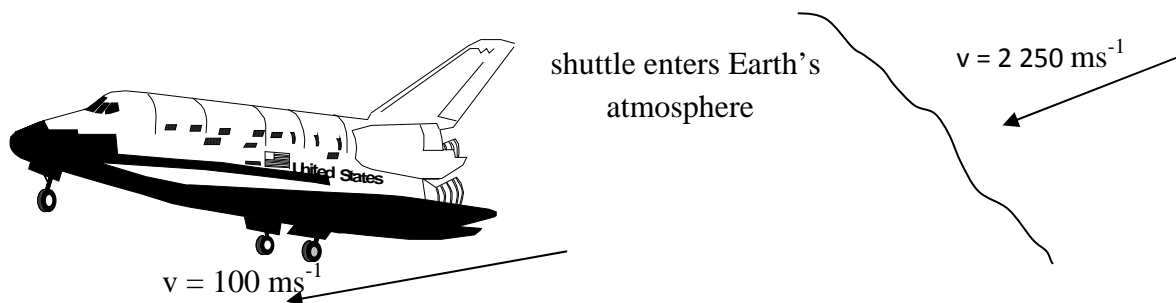

- (a) How much kinetic energy do the tiles on the nose of the shuttle lose?
 (b) How much heat energy is produced at the nose during re-entry?
 (c) Calculate the specific heat capacity of the material used to make the nose tiles.

7. A multistage rocket jettisons its third stage fuel tank when it is empty. The fuel tank is made of aluminium and has a mass of 4 000 kg.
(specific heat capacity of aluminium is $900 \text{ J kg}^{-1} \text{ }^\circ\text{C}^{-1}$)

- (a) Calculate the kinetic energy lost by the fuel tank as it slows down from $5\,000 \text{ ms}^{-1}$ to $1\,000 \text{ ms}^{-1}$ during its journey through the Earth's atmosphere.
- (b) How much heat energy is produced?

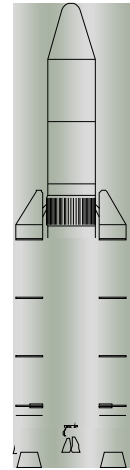

8. In 1969 Apollo 11 returned to Earth with a velocity of $11\,200 \text{ ms}^{-1}$ on entering the Earth's atmosphere. It had a mass of 5 500 kg and slowed down over a distance of 10 000 000 m in the atmosphere, before splashing into the ocean .

- (a) Calculate the kinetic energy of Apollo 11 as it entered the Earth's atmosphere.
- (b) How much work was done by the frictional forces which brought it to rest?
- (c) Calculate the average force it experienced as it slowed down over 10 000 000 m in the atmosphere.

9. Re-entry for a certain shuttle begins 75 miles above the Earth's surface at a speed of 10 km s^{-1} . It is slowed to a speed of 100 ms^{-1} by frictional forces during which time it has covered a distance of $4 \times 10^7 \text{ m}$. The mass of the shuttle and its payload is $2.4 \times 10^6 \text{ kg}$.

- (a) Calculate the loss in kinetic energy of the shuttle.
- (b) How much work is done by friction?
- (c) Calculate the average size of the frictional forces exerted by the atmosphere on the shuttle as it slows down.

10. At touch down a shuttle is travelling at 90 ms^{-1} . The brakes apply an average force of $4 \times 10^6 \text{ N}$ in total to bring the shuttle to a stand still. The mass of the shuttle is $2 \times 10^6 \text{ kg}$.

- (a) How much kinetic energy does the shuttle have at touch down?
- (b) How much work must be done by the brakes to stop the shuttle?
- (c) Calculate the length of runway required to stop the shuttle.

26. Cosmology and the Light Year

National 5

In this section you can use the following equation:

$$\bar{v} = \frac{d}{t}$$

Where : \bar{v} = average speed in meters per second (ms^{-1})
 d = distance travelled in metres (m)
 t = time taken in seconds (s).

Helpful Hint

Because distances in space are so large, astronomers use **light years** to measure distance.

One light year is the **distance** light will travel in one year. **1 year is 365.25 days.**

Light travels at **$3 \times 10^8 \text{ ms}^{-1}$** .

1. Calculate how far, in metres, light will travel in 1 year?
2. The star Vega is 27 light years from earth. How far away is Vega in metres?
3. The star Pollux is 3.78×10^{17} m from earth. How far is this in light years?
4. The star Beta Centauri is 300 light years from earth. How long does it take light to travel from this star to the earth? (Give your answer in years.)
5. An astronomer on Earth views the planet Pluto through a telescope. Pluto is 5.763×10^{12} m from earth. How long did it take for the light from Pluto to reach the telescope?
6. Our galaxy, the Milky Way, is approximately 100 000 light years in diameter. How wide is our galaxy in metres?
7. The nearest star to our solar system is Proxima Centauri which is 3.99×10^{16} m away. How far is this in light years?
8. Andromeda (M31) is the nearest galaxy to the Milky Way and can just be seen with the naked eye. Andromeda is 2.1×10^{22} m away from the Milky Way. How long does it take for light from Andromeda to reach our galaxy?
9. The Sun is the nearest star to the planet Earth. It takes light 8.3 minutes to reach us from the Sun. Use this information to find out the distance from the Earth to the Sun in metres?
10. Sir William Herschel, an amateur astronomer, discovered the planet Uranus in March 1781. Uranus is 2.871×10^{12} m away from the sun. How long does it take for sunlight to reach Uranus?

27. The Observable Universe

National 4 and National 5

1. Read the following clues and select the answer from this list. Some answers can be used more than once.

star	moon	planet	solar-system
universe	exo-planet	galaxy	light year

- (a) The distance light travels in one year.
 - (b) A ball gases continually reacting to give out heat and light.
 - (c) This orbits a star.
 - (d) Our Sun and its 8 planets.
 - (e) Everything?
 - (f) A large group of stars.
 - (g) A natural satellite of Earth.
 - (h) The Sun is one of these.
 - (i) The Milky Way is one of these.
 - (j) This orbits a star outside our solar system.
2. How can Scientists detect exo planets?
3. A planet would need to meet several requirements in order to sustain life as we know it. Some suggestions are written below. Write down TRUE or FALSE for each one.
- (a) The planet must be not too big and not too small.
 - (b) The planet must already have intelligent life on it.
 - (c) The planet surface must be liquid and gas.
 - (d) The planet must be in orbit around a stable, long lived star.
 - (e) The planet must be very close to its star.
 - (f) The planet must have a protective electromagnetic field.

National 5

4. Scientists widely agree that all matter was once packed into a tiny space, then the Universe was created as a result of a massive explosion.
- (a) What is the name of the theory that attempts to explain this origin of the Universe?
 - (b) By this theory, how long ago did this explosion happen?
 - (c) Nowadays, are our galaxies STABLE or STILL MOVING APART or MOVING CLOSER TOGETHER?
 - (d)
5. High frequency radiation like Ultraviolet, X-Rays and Gamma rays are given off by extreme astronomical events.
Give 2 examples of “extreme astronomical events” and explain what they are.

6. Identify the types of spectra shown in the following diagrams.

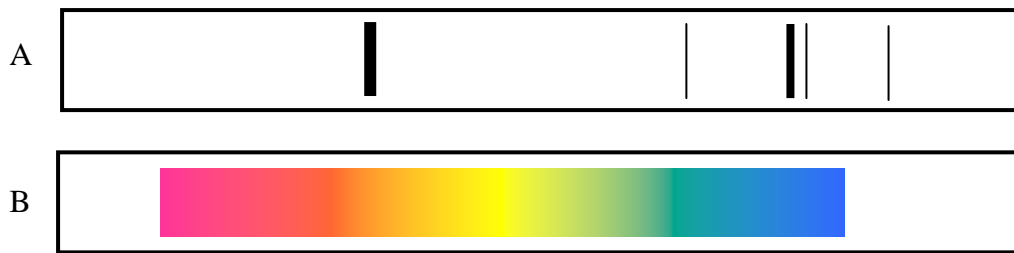

7. Spectral data from a distant star is shown below.

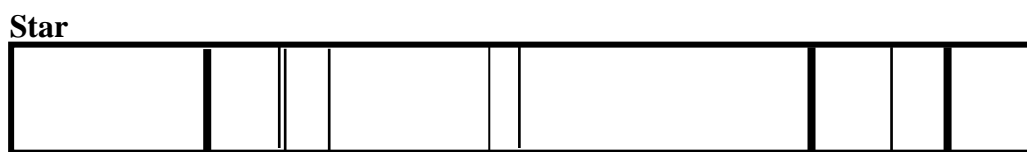

Known spectral data from various elements is as follows:

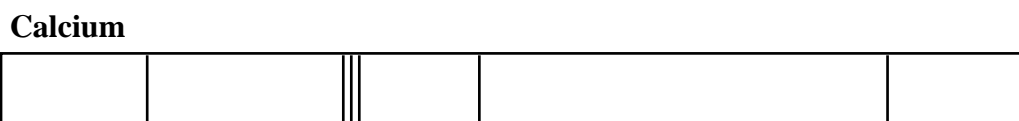
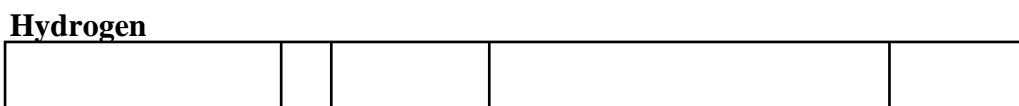

Identify the elements present in the star.

8. The temperature of a star can be estimated by the frequency / colour of light that it emits.

(a) Is the blue end of the spectrum the high or low frequency end?

Look at the following chart and use it to answer the questions below.

Spectral Type	Example(s)	Temperature Range	Key Absorption Line Features	Brightest Wavelength (color)
O	Stars of Orion's Belt	>30,000	Lines of ionized helium, weak hydrogen lines	<97 nm (ultraviolet)*
B	Rigel	30,000 K–10,000 K	Lines of neutral helium, moderate hydrogen lines	97–290 nm (ultraviolet)*
A	Sirius	10,000 K–7,500 K	Very strong hydrogen lines	290–390 nm (violet)*
F	Polaris	7,500 K–6,000 K	Moderate hydrogen lines, moderate lines of ionized calcium	390–480 nm (blue)*
G	Sun, Alpha Centauri A	6,000 K–5,000 K	Weak hydrogen lines, strong lines of ionized calcium	480–580 nm (yellow)
K	Arcturus	5,000 K–3,500 K	Lines of neutral and singly ionized metals, some molecules	580–830 nm (red)
M	Betelgeuse, Proxima Centauri	<3,500 K	Molecular lines strong	>830 nm (infrared)

* All stars above 6,000 K look more or less white to the human eye because they emit plenty of radiation at all visible wavelengths.

- (b) Light from which end of the spectrum, blue or red, indicates a hotter star?
- (c) Our nearest star is our Sun. Which spectral type is our Sun?
- (d) Which 3 spectral types emit the strongest radiation outside of the visible spectrum?
- (e) Where are some of the hottest stars?

28. Conservation of Energy – Extension Calculations

National 5

Helpful Hint

When an object falls its potential energy is converted to kinetic energy (assuming air resistance is negligible).

$$\text{i.e.} \quad E_p \quad \longrightarrow \quad E_k$$

We can use this principle of **conservation of energy** to solve many problems.

e.g. a ball (mass m) falling through a height, h .

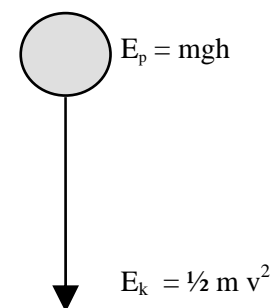

Finding the **landing velocity** of a falling object.

$$\begin{aligned} E_p &= E_k \\ mgh &= \frac{1}{2} mv^2 \end{aligned}$$

So, rearranging this:

$$v = \sqrt{2gh}$$

Finding the **height** through which an object falls.

$$\begin{aligned} E_k &= E_p \\ \frac{1}{2} mv^2 &= mgh \end{aligned}$$

So, rearranging this:

$$h = \frac{v^2}{2g}$$

FOR SIMPLICITY, in this section, use $g = 10 \text{ N kg}^{-1}$ on Earth.

1.

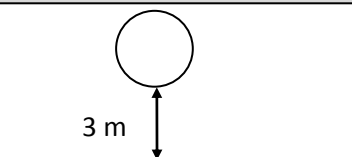

A 2 kg ball falls through 3 m to land on Earth.

- (a) How much potential energy does it lose during its fall?
- (b) How much kinetic energy does it gain during its fall, assuming that there is no air resistance?
- (c) Calculate the maximum speed of the ball as it hits the ground.

2.

A spanner falls from a desk which is 0.8 m high. If the spanner has a mass of 0.5 kg, calculate :

- (a) the potential energy lost by the spanner as it falls
- (b) the kinetic energy gained by the spanner as it falls, assuming negligible air resistance.
- (c) the speed of the spanner just as it hits the ground.

3. A pencil case has a mass of 0.2 kg and is dropped from a height of 0.45 m.
- How much potential energy does the pencil case lose as it falls to the ground?
 - What is the kinetic energy of the pencil case as it hits the ground?
 - With what speed does the pencil case hit the ground?

4. A trolley rolls towards a ramp with a speed of 2 ms^{-1} . The trolley has a mass of 0.3 kg.



- Calculate the kinetic energy of the trolley before it goes up the ramp.
 - If there are no energy losses due to friction how much potential energy does the trolley gain as it goes up the ramp?
 - What height does the trolley reach on the ramp?
5. A skateboarder, of mass 65 kg travels towards a hill with a speed of 5 ms^{-1} .

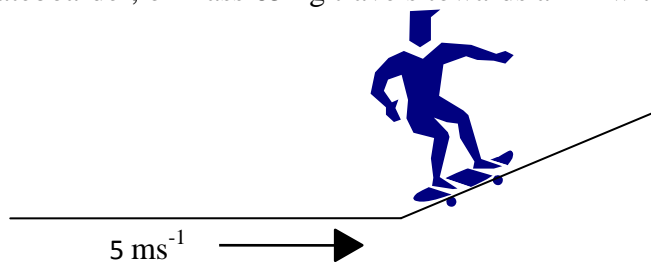

- What is the kinetic energy of the skateboarder as he travels towards the hill?
 - If there are no energy losses due to friction, how much potential energy will the skateboarder gain on the hill?
 - What height will the skateboarder reach on the hill?
6. An 8 kg boulder rolls down a hill as shown below.

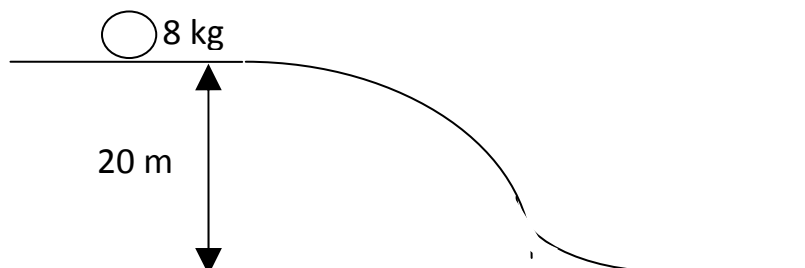

- How much potential energy does the boulder lose as it rolls down the hill?
- Calculate the speed of the boulder at the bottom of the hill, assuming that no energy is lost due to friction?

7. A diver, who has a mass of 70 kg, dives from a cliff top into the sea. The cliff top is 11.25 m above the water surface. At what speed does the diver enter the water, assuming that frictional effects are negligible?
8. A box is released from a helicopter which is hovering 10 m above the ground. Calculate the speed of the box as it strikes the ground, assuming that frictional effects are negligible.
9. A twenty pence piece falls from the top of a skyscraper and lands, on the street below, with a speed of 80 ms^{-1} . How tall is the skyscraper? (Assume that there is no air resistance.)
10. A crate is released from a crane while it is hanging 20 cm above the ground.

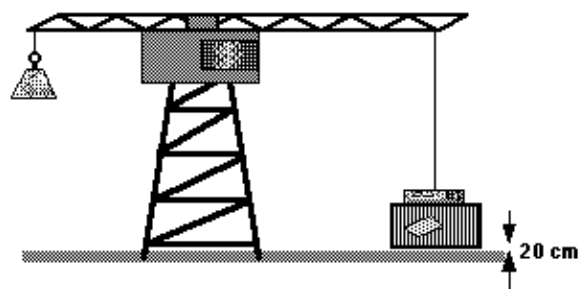

With what speed does the crate land on the ground?

11. An advertising company produces a stunt where a girl on horseback jumps across a gap between two buildings. The combined mass of horse and rider is 420 kg and they are galloping with a speed of 28 ms^{-1} as they leave the first building. The roof of the second building is 1 m below the roof of the first one.
 - (a) Calculate the kinetic energy of the horse and rider as they leave the first building.
 - (b) How much gravitational potential energy do the horse and rider lose during the stunt?
 - (c) Assuming that there are no energy losses due to air resistance, what is the total amount of kinetic energy of the horse and rider as they land on the second building?
 - (d) With what speed do the horse and rider land on the second building?
12. If a bullet is fired vertically upwards, with a speed of 150 ms^{-1} , what is the maximum height it could reach if frictional effects are negligible.
13. A skateboarder moves towards a slope with a constant speed of 8 ms^{-1} . Her mass, including her skateboard, is 60 kg and she reaches a height of 2.5 m on the slope. The slope has a rough surface so frictional forces help to slow her down.
 - (a) How much kinetic energy did she have at the foot of the slope?
 - (b) What happened to her kinetic energy as she moved up the slope?
 - (c) How much potential energy did she gain on the slope?
 - (d) How much work was done against friction on the slope?

14. A car, of mass 1 500 kg, is parked on a hill at a height of 20 m. The brakes fail and the car begins to roll towards a busy junction at the foot of the hill. The car reaches the junction with a speed of 18 ms^{-1} .
(Friction between the road and the tyres is important here.)

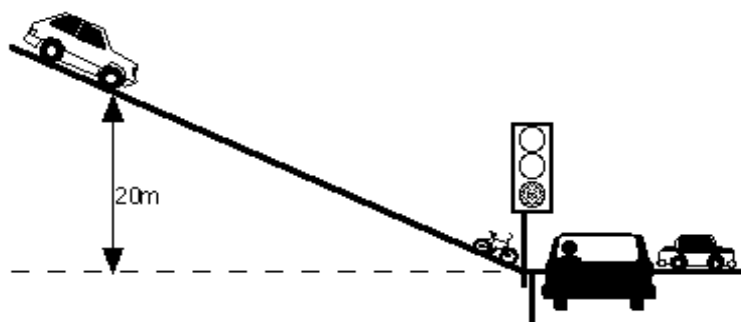

- (a) Calculate the amount of potential energy lost by the car as it rolled down the hill.
 (b) How much kinetic energy did the car have at the junction?
 (c) How much energy was 'lost' due to friction as the car rolled down the hill?
15. A typical loop-the-loop rollercoaster in a fun park is shown below :

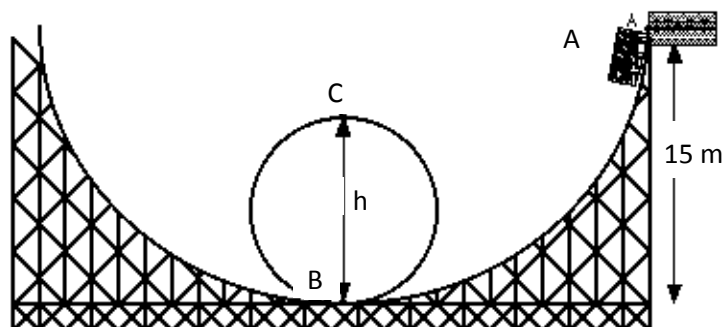

During one ride the total mass of carriage and passengers was 3 000 kg.

When all passengers were locked in place the carriage was pulled up the track to the start point A. This was at a height of 15 m.

The carriage was then released and it sped down the track past point B and round the loop. By the time it had reached the top of the loop, point C, it had lost 6 000 J of energy due to friction and was travelling at 8 ms^{-1} .

- (a) How much potential energy did the carriage lose in going from A to B?
 (b) How much kinetic energy did the carriage have at the top of the loop?
 (c) How much potential energy did the carriage regain in moving from B up to C?
 (d) Calculate the height of the loop.