

## Introduction

This set of worksheets has been written for students working towards GCSE Design and Technology: Resistant Materials. They cover all aspects of the specifications for examinations to be taken from June 2003 onwards.

The worksheets have been designed to be:

### **Student friendly**

- The text has been kept simple, with subject specific concepts explained.
- The diagrams are simple - to be easily understood, easily remembered and easily copied.
- Units are of manageable size.
- Numbered questions can be answered completely by reading the text.

### **Teacher friendly**

- The worksheets can be legally photocopied for in-school use.
- The sheets are versatile and can be used for – homework – revision – instruction sheets during practical lessons – back up for practical demonstrations – work set when specialist staff are absent.
- There are two levels of questions at the end of each unit – numbered and lettered questions.
- The numbered questions are easily marked because the answers are in the text.
- The lettered questions need further research or thought and are suitable for homework.
- If a student has answered a full set of end of unit questions, they will have read the whole text.

## **THE AUTHOR**

Paul Philpott has been at the sharp end of teaching Design and Technology subjects for more than thirty years. He has been Head of CDT at both,

Queen Elizabeth's Boy's School – Barnet  
and  
Newmarket Upper School – Suffolk

## **ACKNOWLEDGMENTS**

I especially wish to thank my wife and family for their support and Bill Massey of Cable Educational Ltd for taking me on and encouraging me. I also wish to thank all the students that I have taught over the years for teaching me what works and what does not!

**ISBN: 1-904518-95-8**

First edition published 2002

This edition published 2004

© 2004 Cable Educational Ltd Version 2.4 (September 2005)

This document may be photocopied for use in the purchasing establishment only

# D & T RESISTANT MATERIALS CONTENTS

	Worksheet		Worksheet
<b>1. Knowledge and Understanding</b>		<b>5. Making in Metal</b>	
Safety matters	1	Selecting metals	24a-24b
Systems and control	2	Marking out metal	25
Mechanical systems	3a-3e	Shaping metal – wasting	26a-26e
Structural systems	4	Forming metal	27a-27d
Material properties and testing	5	Casting metal	28a-28b
Ergonomics & anthropometrics	6	Joining metal	29a-29f
		Heat treatment	30
<b>2. Commercial Production Methods</b>		Metal finishes	31
Templates and jigs	7a-7b	Metal commercial production	
CAD/CAM	8	Methods	32a-32b
Manufacturing systems	9a		
Quality	9b-9c	<b>6. Making in Plastics</b>	
Recycling	9d	Selecting plastics	33
		Marking out plastics	34
<b>3. The Design Process</b>		Shaping plastics – wasting	35
Problem analysis & research	10a	Forming plastics	36a-36c
Specification	10b	Joining plastics	37
Producing ideas	10c	Finishing plastics	38
Developing ideas	10d	Plastics commercial production	
Modelling ideas	10e	Methods	39a-39b
Presenting ideas	10f		
Workplans	10g	<b>7. Modern materials</b>	
Evaluation	10h	Smart materials	40
<b>4. Making in Wood</b>			
Wood processing	11a		
Selecting wood	11b-11c		
Preparing wood for use	12		
Marking out wood	13		
Shaping wood – wasting	14a-14f		
Joining wood	15a-15c		
Joint cutting instruction sheets	16a-16f		
Wood adhesives	17		
Mechanical fixings	18a-18b		
Laminating	19		
Wood finishes	20a-20b		
Turning wood	21		
Woodworking power tools	22		
Wood commercial production			
Methods	23		



**SAFETY MATTERS**

Safety in the school workshop is the responsibility of everyone who uses the workshop. Accidents usually happen when people are fooling about or being careless.

**Teachers** are responsible for checking that:

- Machines are set up properly
- Safety guards are fitted
- Stop buttons work and are accessible
- Electrical cut-out devices work
- Warning signs are displayed
- The first-aid box is kept topped up
- Fire drill procedures are posted
- Dust extraction units work
- Safety clothing and equipment is available
- Pupils are shown how to use each tool and machine safely
- Workshop safety rules are given, kept to, and understood by all

**Pupils** are responsible for:

- Following the general safety rules at all times
- Only using tools and machines they have been given permission to use
- Using the machines and tools only in the way that the teacher instructed
- Using tools and machines only for the job they are designed for
- Making use of all machine guards
- Reporting any defects of tools or machines immediately
- Reporting any liquid spillage immediately
- Reporting any accidents, however minor, to the teacher
- Considering the safety of everybody else in the workshop
- Behaving sensibly at all times, especially when the teacher's back is turned
- Using chemicals and smelly adhesives in a ventilated area
- Not leaving hot materials lying around
- Not interfering with other pupils while they are working
- Not throwing anything in a workshop
- Not encouraging others to behave dangerously

For your own safety:

- Wear an apron
- Tie back any long loose hair
- Remove any dangling earrings or bracelets
- Secure loose shirt cuffs or shirt tails.
- Make sure your laces are tied up
- Wear stout shoes
- Do not run in the workshop
- Wear safety clothing when appropriate e.g. goggles, face mask etc.

**SAFETY SIGNS**

There are three types of safety sign:

**Red** signs show things that are not allowed

**Blue** signs show things that must be done

**Yellow** signs are warnings.

These are **Red** signs.



These are **Blue** signs.

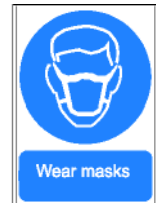

These are **Yellow** signs.



**Caution risk of electrical shock**



**Caution toxic hazard**



**Caution risk of fire**

**AT WORK**

In factories there are laws that control Health and Safety. The main law is the -

**Health and Safety at Work Act 1974**

This law says that employers must take all reasonable care to ensure the safety of their employees and that employees should co-operate with the employer to ensure the safety of all workers.

**A** Write a list of safety rules for your school workshop, using your own words and in your own style.

**B** Take any one of the safety rules and produce an A4 size poster illustrating the rule in a manner suitable for putting up on the workshop wall.

**SYSTEMS AND CONTROL**

There have been many technological advances in the last fifty years, but it is those that are connected with systems and control that have had the greatest influence upon our lives. Whenever you see the word automatic or 'auto', connected with a product you know it's based upon a system that it can control.

**System Representation**

Any system can be broken down into three parts and can be represented by a **black box**. A black box is a system that you know how to operate and you know what it does, but you don't know how it works. e.g. When you want to change channels while watching TV, you know that if you press the correct button on the remote control the TV will change to the channel you want. But do you know how it works?

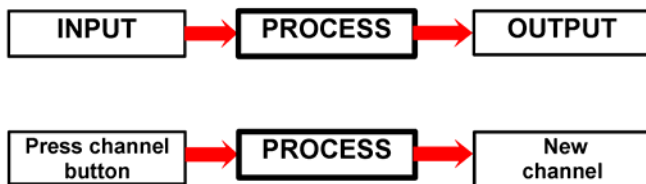

The diagram above shows a simple system, such as changing channels on a TV. This is known as a **closed loop system** and is not automatic.

A more complicated system can sense changes in the environment and **control** the system e.g. A central heating system will switch off when the set temperature has been reached and switch on again when it gets too cold.

The system can sense the temperature and feeds back the information to the switch. This is known as **feedback** and the system is called an **open loop system** and can be called automatic.

The central heating system can be shown by using a flowchart.

A flowchart is made up of specially shaped boxes. The shapes mean:

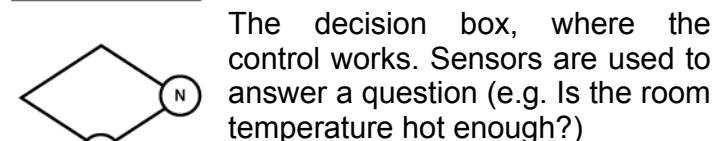
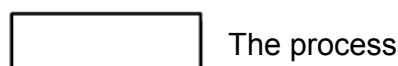
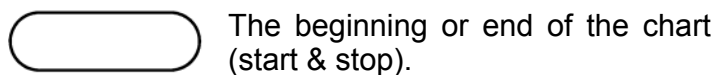

**Y = Yes N = No** (they can be the other way round)

**KEY WORDS** Input: Process: Output: Feedback: Sub-system

**The central heating system**

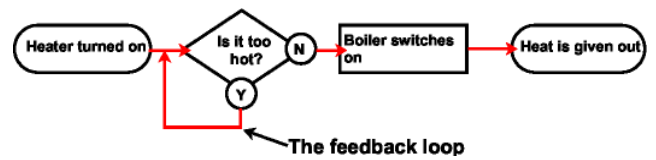

There are many types of sensors that can provide the feedback loop. Sensors can sense levels of:

- |          |           |          |
|----------|-----------|----------|
| Light    | Heat      | Sound    |
| Pressure | Tension   | Position |
| Movement | Vibration | Speed    |

In complex systems the information collected by the sensor is fed into a **micro-chip** circuit. It is this circuit that controls what happens.

**SYSTEMS AND SUB-SYSTEMS**

In more complex systems such as those found in an automatic washing machine or a DVD player, there are a number of linked systems called sub-systems that work together to make the product work correctly. e.g. In a washing machine there is a sensor for sensing the temperature of the water and a sensor for sensing the height of the water in the drum. The washing program will not start until the water is at the correct height and at the correct temperature.

In a DVD player there are a number of sub-systems:

- The disc feed sub-system
- The disc spinning sub-system
- The laser movement sub-system
- The laser reading sub-system
- The conversion for TV sub-system
- They must all work together and feedback information to each other for the player to work well.

1. What does the word 'automatic', when referring to a product, mean to you?
  2. What are the three parts that can represent a system?
  3. What does the term 'black box' mean?
  4. Draw a black box system diagram for switching on a light.
  5. Describe the term 'feedback'.
  6. What is the difference between an open loop and a closed loop control system?
  7. Draw the three main flowchart box shapes and state what each box shape means.
  8. Make a list of the things that sensors can sense and measure.
  9. Describe a sub-system.
  10. Give an example of a product made up of sub-systems and list the sub-systems.
- A** Construct a flowchart to show the system you would use to make a cup of tea or coffee. Remember to use decision boxes and feedback loops to check things as you go along.
- B** List the sub-systems that make up a video recorder.

**MECHANISMS**

All tools and machines are made up of mechanisms, a complicated machine is lots of mechanisms working together. Mechanisms are used to improve our own abilities, e.g. we can hit a nail harder with a hammer (a lever mechanism) than we can by hitting it with a stone held in the hand and we can move faster on a bicycle than by running.

**Mechanisms as a system**

All mechanisms are to do with movement and energy.

Every mechanism can be split into three parts:

**Input** – the energy put in, e.g. the squeezing together of the handles of a pair of scissors.

**Process** – the movement of the mechanism, e.g. the movement of the scissors blades.

Many mechanisms change one type of movement to another.

**Types of movement:**

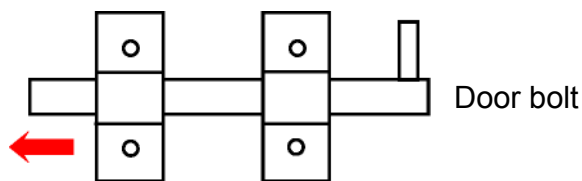

**Reciprocating** - straight line, forwards and backwards movement

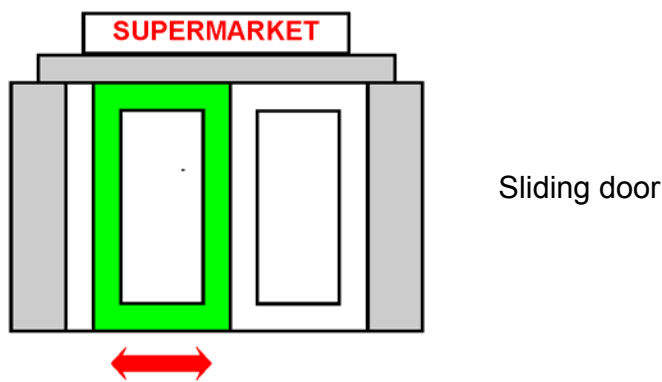

**Rotary** - circular movement

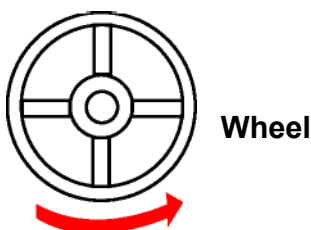

**Oscillating** – circular forwards and backwards movement.

**Clock**

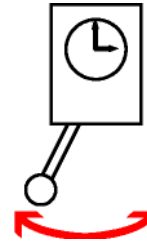

**pendulum**

Windscreen wiper

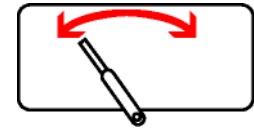

**LEVERS**

A lever was probably one of the first tools to be used by humans. Levers enable you to lift or move objects that are far heavier than you could deal with on your own.



A lever system is made up from three parts:

- The **Effort** put in to move the lever
- The **Load** the weight of the object moved
- The **Fulcrum** the point at which the lever turns or pivots.

There are three classes of lever. Each class depends upon what is in the **middle** of the system.

**Class 1**

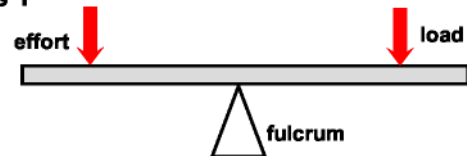

**Class 2**

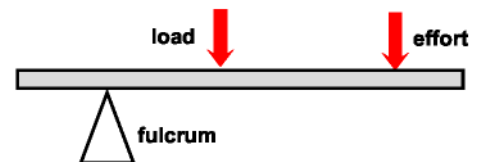

**Class 3**

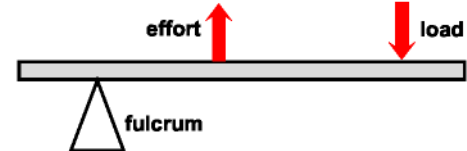

To help you remember which is which, try to learn the rhyme **1 2 3 – F L E** (F L E are the initial letters of what is in the middle)

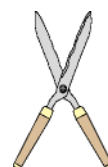

**Class 1**



**Class 2**



**Class 3**

When a mechanism such as a lever improves the effect of an effort, the mechanism is said to have provided a **Mechanical Advantage (MA)**. To work out what this is, the following formula can be used:

$$MA = \text{LOAD} \div \text{EFFORT}$$

Load and effort are measured as a force in **Newtons**. So, if an effort of 4 newtons is used to move a load of 8 newtons:

$$MA = 8 \div 4 = 2$$

i.e. the mechanism can double the force of the effort. Unfortunately, you cannot get something for nothing and to lift the load you will have had to do some work (make the effort).

**Work** = effort x distance moved (metres) (Work is measured in newton/metres)

e.g. If you lift a lever 1.5 metres using an effort of 12 newtons then you will have done  $1.5 \times 12 = 18$  Nm of work.

If a mechanism has a  $MA = 2$  then the distance moved by the effort will be twice that moved by the load

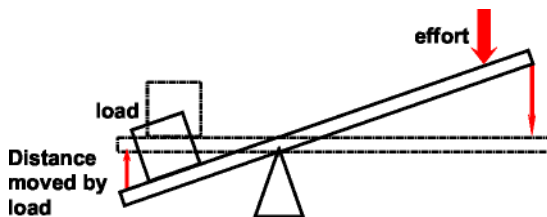

Since the effort and the load started to move at the same time and stopped at the same time, but the effort moved twice as far, the effort moved faster than the load. The difference between the two speeds is known as the

$$\text{Velocity Ratio} = \frac{\text{Distance effort moves}}{\text{Distance load moves}}$$

**Torque (turning force)**

The turning force of a lever, e.g. spanner, is larger when the effort is further away from the fulcrum. You can get more torque from a spanner with a long handle, than one with a short one.

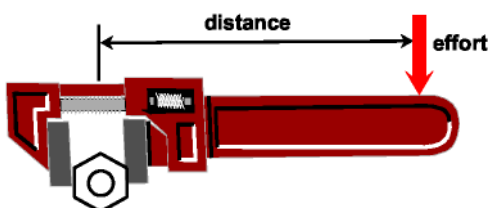

$$\text{Torque} = \text{Effort (newtons)} \times \text{Distance (metres)}$$

**LINKAGES**

Linkages are lever systems that can change the direction of the effort force.

**Reverse motion linkage**

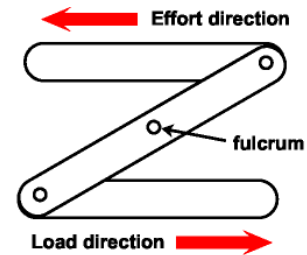

**Bell crank (90° change of direction)**

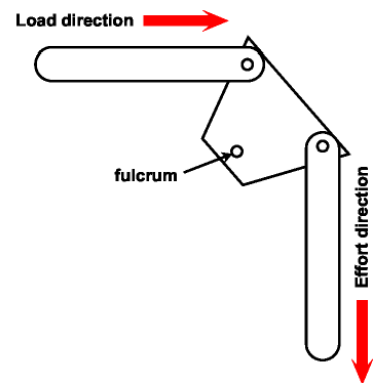

**KEY WORDS** Linear: Reciprocating: Rotary: Oscillating: Effort: Load: Fulcrum: Torque:

1. What are mechanisms used for? Give two examples.
  2. Explain the three parts of a mechanical system.
  3. Describe the following types of movement using diagrams and notes - rotary, linear, oscillating and reciprocating.
  4. How might you remember the three classes of lever?
  5. Draw the garden tools on the previous page and show where the effort, load and fulcrum should be in each case.
  6. Explain the term 'mechanical advantage' and state its formula.
  7. If a mechanism allows a load of 10 newtons to be moved by an effort of 2 newtons, what is its MA?
  8. Explain the term 'velocity ratio' and state its formula.
  9. If in a mechanism the effort moves 6 metres and the load moves 2 metres, what is the velocity ratio?
  10. What is the torque, when an effort of 8 newtons is made by using a spanner with a handle of 250mm (0.25M) in length?
- A** Sketch **four** different examples from those given, of mechanisms using rotary, reciprocating, linear and oscillating movement.
- B** Sketch **three** different examples from those given, of tools that use one of each of the three classes of lever mechanism.



**PULLEYS**

A pulley is a wheel with a groove around its edge in which a belt, rope or chain can sit. Its most simple use is to help lift a heavy object by pulling down on a rope instead of lifting it directly, which could damage your back.

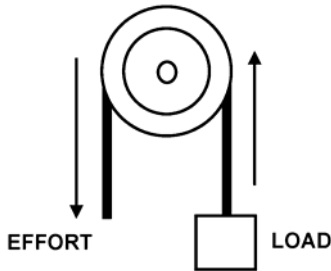

When a single pulley is used there is no mechanical advantage gained, only a change of effort direction to make the lifting more convenient. The distance you pull the rope down is the same distance that the load will move up. To be able to lift a heavier load you must use a pulley system with two or more pulley wheels.

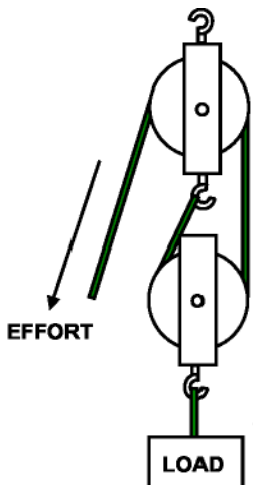

The **Mechanical Advantage (MA)** of a pulley system is the same value as the number of pulley wheels. The system shown in the diagram has two pulley wheels, so the MA = 2. With a two wheel system the distance you pull the effort rope down is twice the distance the load moves up. Therefore an effort of 5 newtons can lift a load of 10 newtons.

**Transferring motion**

As part of a machine, pulleys attached to shafts can be used to transfer rotary motion from one place to another and also change the speed of the motion. e.g. as found in a pillar drill to change the speed that the drill bit turns.

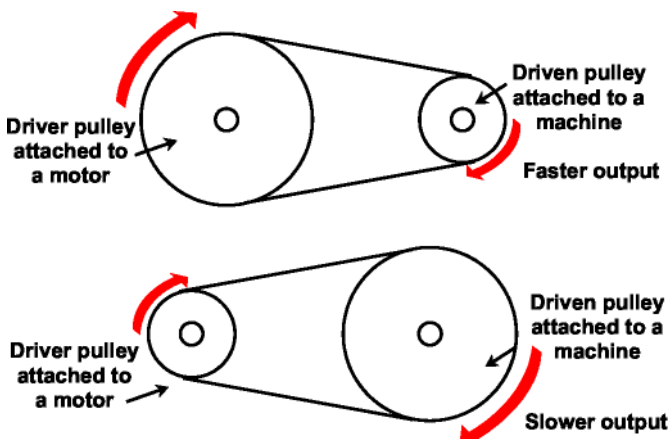

Loads are limited, if the system is overloaded then the belt slips. This can be regarded as a safety feature.

The speed ratio is dependent upon the diameters of the pulleys, the formula is:

$$\text{Speed ratio} = \frac{\text{Diameter of driver pulley}}{\text{Diameter of driven pulley}}$$

If the driver pulley is 120mm diameter and the driven is 60mm, then

$$\text{Speed ratio} = 120 \div 60 = 2$$

This means that if the driver pulley turns at 200 revolutions per minute (rpm) then the driven pulley will turn at 400rpm.

To change the direction of rotation the belt must be crossed over.

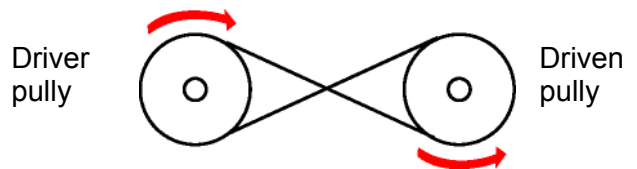

**GEARS**

Gears wheels, like pulleys, are used for transferring rotary motion. A gear system can take a higher load than a pulley system, if it is overloaded the teeth tend to break off and the system is ruined.

**Spur gear**

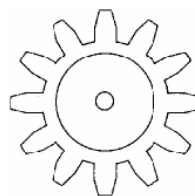

Because the gear is difficult to draw we often use the graphical symbol shown on the right.

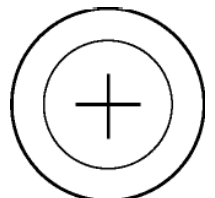

**Gear systems**

When two gears are used together, the speed change, known as the **gear ratio**, is dependnt upon the number of teeth on each gear wheel.

$$\text{Gear Ratio} = \frac{\text{Number of teeth on driver gear}}{\text{Number of teeth on driven gear}}$$

e.g.

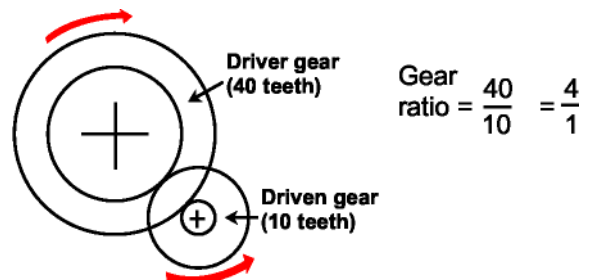

This gear ratio can be written as 4 to 1 or 4:1 and means that the driven gear will turn four times faster than the driver gear. Number of teeth on driver gear Number of teeth on driven gear.

Two meshing gears turn in opposite directions. To get the driver and driven gears to turn in the same direction an idler gear needs to be added to the system.

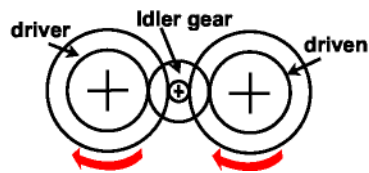

The number of teeth on the idler gear has no effect upon the gear ratio formula.

Gears are very useful for changing the rotary speed of an electric motor. With two gears meshing, a change of more than 10:1 or 1:10 is unlikely because the teeth on each gear have to be the same size to mesh, so the larger gear would have to be ten times larger. To overcome this problem a number of gears are meshed together in a **gear train**. For the train to make a large speed change, some gears of different size need to be joined together on the same shaft so that they turn together.

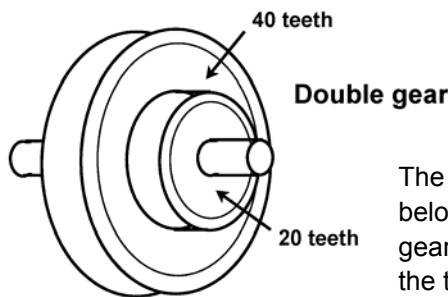

Double gear

The gear train shown below has the double gear in the middle of the train

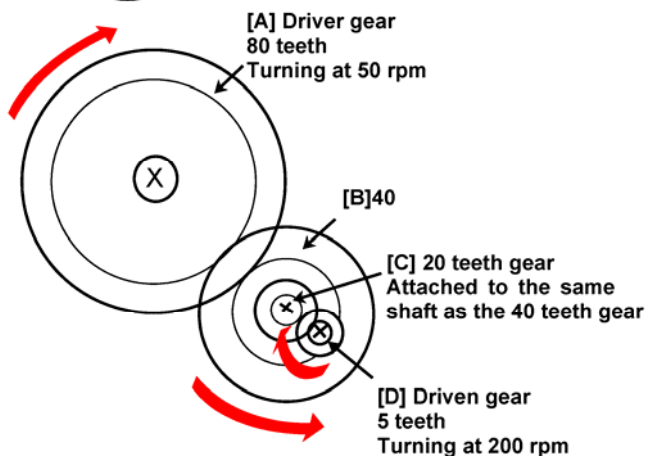

To work out the final speed of the driven gear. The ratio between gears A & B is:

Gear Ratio =  $80 \div 40 = 2:1$  therefore gear B turns twice as fast at 100 rpm. Gear C is on the same shaft so will also turn at 100 rpm.

The ratio between gears C & D is:

Gear Ratio =  $20 \div 5 = 4:1$  therefore gear D is turning four times as fast, at 400 rpm.

## Gear systems

### Bevel gears

Turn the angle of movement through 90°. You will have used bevel gears when using a hand drill, the drill chuck is held at 90° to the turning handle.

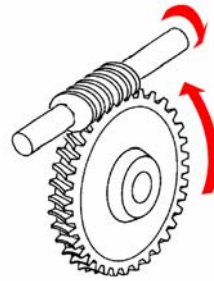
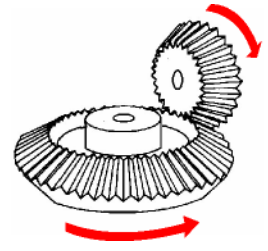

### Worm gear

This system also turns the angle of movement through 90°. Its main use is to reduce the speed of a motor. The worm gear has to be the driver gear because if the spur gear is connected to the motor the system locks up.

When the worm gear turns one full revolution the spur gear turns only a one tooth distance. If there are 40 teeth on the spur gear then it will take 40 turns of the worm gear to make it turn 1 complete revolution. The gear ratio is 1 : 40. It is always 1 : number of teeth on the spur gear.

### Rack and pinion

The rack is like a flat gear wheel and the pinion is the spur gear. This system changes rotary motion to linear motion. When the spur gear turns, the rack moves to the side in a straight line. This is used in car steering systems.

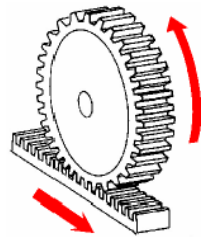

1. When using a single pulley system, if the effort is moved 2 metres, how far does the load move?
2. What is the relationship between the mechanical advantage of a pulley system and the number of wheels used in the system?
3. When using a four wheel pulley system, if the effort made is 15 newtons, what is the largest load that the system should be able to lift? (show your working out).
4. Draw a motor pulley drive system where the output is slower than the motor.
5. State the speed ratio formula for a pulley drive system.
6. Draw the graphical symbol for a spur gear.
7. What is the gear ratio formula?
8. In a two gear system the driver gear has 20 teeth and turns at 900 rpm, the driven gear has 60 teeth, at what speed will it turn? (draw the system using symbols)
9. What is the purpose of an idler gear?
10. A worm gear turns at 1,200 rpm, the spur gear has 60 teeth, at what speed does it turn?

**A** List three different machines found in the home that use a pulley drive. State what the drive is used for and whether it is speeding up or slowing down the system.

**B** As for question 'A' but list machines with gear drives.

**KEY WORDS** Mechanical Advantage:  
Mesh: Gear Ratio: Idler Gear



**Mechanical systems**

**Cams**

Cams are used in mechanisms to change rotary motion to reciprocating (backwards and forwards) motion.

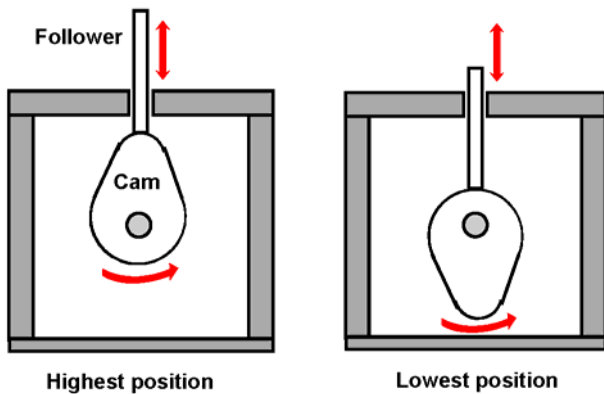

**Basic shapes**

Cams come in many shapes, the three most common shapes are shown below.

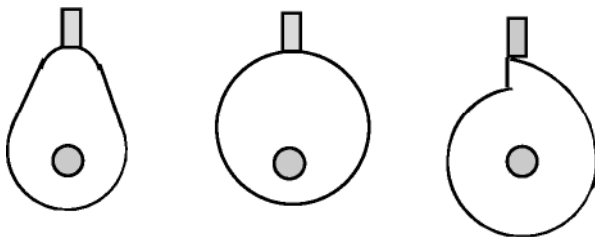

**Pear shaped** The follower stays at the lowest position for half a turn and then rises and falls steadily

**Eccentric** The follower rises and falls steadily

**Ratchet** The follower will rise steadily and fall suddenly. The cam can only turn in one direction without locking

Followers stay touching the edge of the cam either by gravity or they have a return spring fitted to them.

**Cranks**

**Crank and slider**

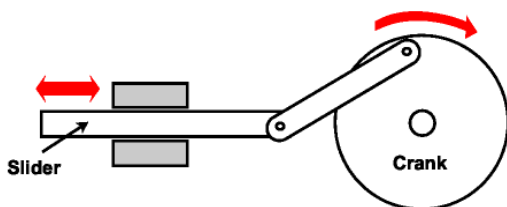

The crank and slider works in a similar way to the cam, except that it both pushes and pulls the slider, unlike the cam that can only push its follower.

The system shown is used in car engines to connect the pistons to the crankshaft. In this case, reciprocating motion of the pistons turns the crankshaft, which through a gearbox, turns the road wheels.

Another form of crank is found on a bicycle, it is the pedal system that is used to turn the large sprocket.

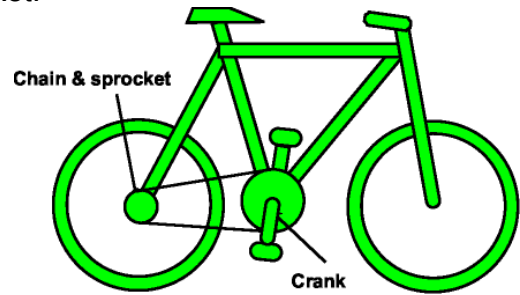

The chain and sprocket is really a form of pulley system that does not allow slippage. (the sprocket is a pulley with teeth, the chain is a metal belt)

**Screw threads**

A screw thread changes rotary motion to linear motion because it moves in or out of a threaded hole when the head is turned. It also has a mechanical advantage because the distance it moves in or out is less than the rotary distance moved when turning the head. A large force can be applied by a screw thread which is why a screw thread is used to operate a bench vice.

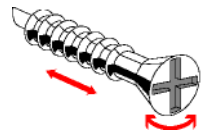

1. What change of motion is caused by using a cam?
2. Draw an eccentric cam and follower in both its highest and lowest position.
3. Draw a ratchet cam that would make the follower rise and fall twice during one revolution of the cam.
4. If the large sprocket wheel of a bicycle is 200mm diameter and the small sprocket wheel is 50mm diameter, how much faster does the back wheel of the bicycle turn than the pedals?

The following questions are based upon the whole of the mechanisms section.

A black box question can have more than one possible solution. e.g.

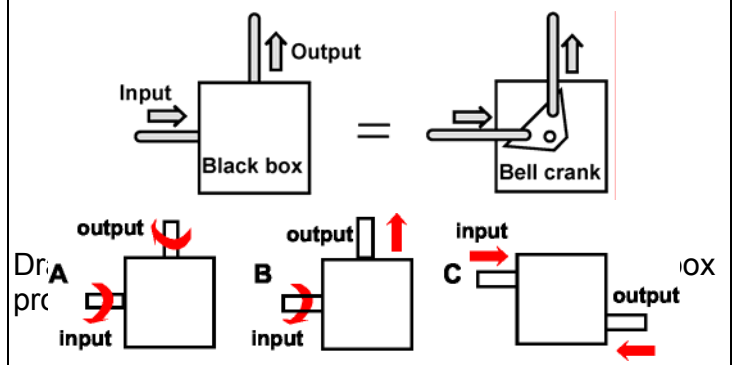

**STRUCTURAL SYSTEMS**

Every product is a structure that is designed to withstand the normal forces that occur during its everyday use.

There are **four** main types of structure:

- **Frame** - made up of beams connected together, e.g. electricity pylons, some bridges, etc.
- **Slab** - made up of boards connected together, e.g. boxes, chipboard based furniture, etc.
- **Monocoque** or **Shell** - made from shaped sheets of rigid material, e.g. car bodies, cans, etc.
- **Flexible** - made from flexible sheets of material, e.g. air-beds, blow-up furniture, etc.

**Note:** Most rigid structures need to be able to flex a little without breaking up, e.g. the forks on a bicycle must flex when it is ridden over bumps in the road and a skyscraper must sway in a high wind.

Structures should be able to resist the following forces:

**Tension** - a pulling force that tries to stretch



**Compression** - a pushing force that tries to squash



**Bending** - a pushing force that tries to curve



**Torsion** - a pushing or pulling force that tries to twist

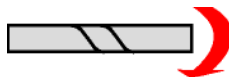

**Shear** - two pushing forces that act in opposite directions and try to slide one part of the structure over the other

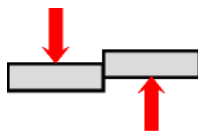

**FRAME STRUCTURES**

A frame structure relies upon the strength of its joints unless it is triangular or made up of triangles. A triangular structure can have loose joints and still be rigid.

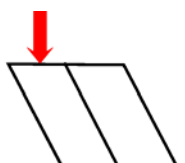
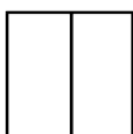

**A gate structure A collapsing gate structure**

If the vertical bar in the middle of the gate is replaced by a diagonal bar then the structure is made up of two triangles and becomes rigid. The bars that make up a frame are called **members**.

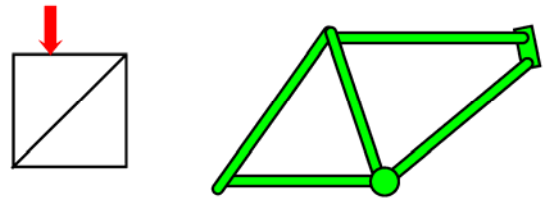

**A rigid gate structure A rigid bicycle frame**

**BEAMS**

A beam is a horizontally placed member that can take a load, e.g. a shelf. When a beam is curved because of a bending force, the top surface is pushed together (compressed) and becomes shorter than it was when the beam was straight. The bottom surface is stretched and becomes longer than it was when the beam was straight.

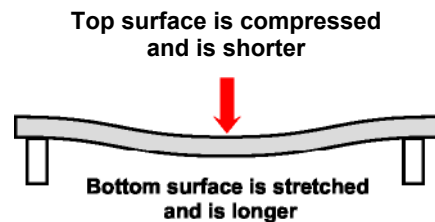

A solid beam can be very heavy. To make the beam lighter in weight but just as rigid, the cross-section is often shaped.

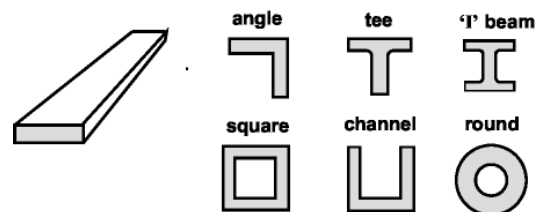

**Cross-section of a solid beam angle tee 'I' beam square channel round**

**KEY WORDS Monocoque Tension Compression Torsion Shear**

1. Describe the four main types of structure.
2. Why do rigid structures need some flexibility?
3. Name and illustrate the types of forces that structures are built to resist.
4. Show how a square frame structure can be made rigid by adding an extra member.
5. What happens to the top and bottom surfaces of a beam when it is being bent by a force?

**A** Fold a single sheet of A4 file paper without using any artificial aids, so that it can span a gap of 180mm and support a tape cassette in its case.

**B** Roll up 12 pieces of A4 file paper lengthways to make round beams, use adhesive tape to hold them in shape, then construct the tallest structure you can that will support a tape cassette in its case at the top. (use adhesive tape to hold the beams together)

**MATERIAL PROPERTIES**

**Choosing Materials**

When a product is being designed, one problem is choosing the most suitable materials for the job. A material should not be chosen just because it looks nice. Using royal blue candle wax for making a door handle is not a good choice! A door handle needs to be able to resist the heat from a hand and also the twisting and pulling forces required to operate it. It is therefore important to understand the various properties of materials, so that you can make a sensible choice of which materials to use when you are designing a product.

**PHYSICAL PROPERTIES**

Physical properties are the basic properties of each material.

**Density**

is the amount of matter (mass) in a material. A cube made from a high density material will be heavier than the same size cube made from a low density material.

DENSITY	MATERIAL
High	Gold Lead
Medium	Copper Steel
Low	Woods Plastics

**Fusibility**

is a measure of how easy it is to melt the material. The temperature at which the material normally melts is known as the **melting point**.

MELTING POINT	MATERIAL
High	Tungsten Chromium
Medium	Copper Steel
Low	Zinc Lead

**Note:** A highly fusible material has a low melting point.

**Thermal Conductivity**

is a measure of how fast heat can travel through a material. A material is known as an **insulating** material if heat travels through it very slowly.

THERMAL CONDUCTIVITY	MATERIAL
High	Copper Aluminium
Medium	Mild steel Tin
Low	Woods Polystyrene

**Electrical Conductivity**

is a measure of how fast electricity travels through a material. Generally a good conductor of heat is also a good conductor of electricity. A poor conductor is an **Insulator**.

MELTING POINT	MATERIAL
High	Gold Copper
Medium	Steel Zinc
Low	Woods Nylon

**Thermal Expansion**

is the amount of expansion that occurs when the material is heated. A high expansion material will become noticeably larger when heated.

THERMAL EXPANSION	MATERIAL
High	Polythene Nylon
Medium	Aluminium Tin
Low	Woods Titanium

**Optical Properties**

Most materials do not let any light pass through them, these are known as **Opaque** materials. Others like glass can let light pass easily through them, these are known as **transparent** (see-through) materials. There are also materials like some plastics or frosted glass that let some light through, but detail of what is on the other side of the material cannot be seen, these are known as **Translucent** materials.

**MECHANICAL PROPERTIES**

Mechanical properties are connected with how a material reacts to forces applied to it.

A force will **deform** a material. If the deformation is temporary and the material returns to its original state then it is said to be **elastic**, if it is permanent and the material stays in its new state, it is said to be **plastic**.

**Strength**

is a measure of how well a material can withstand force without permanently bending or breaking. There are different types of strength measurements.

**Tensile strength** - resists being crushed e.g. cast iron



**Shear strength** - resists sliding forces such as those made by scissors

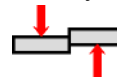

**Compressive strength** - resists being crushed e.g. cast iron



**Torsional strength** - resists twisting e.g. tool steel

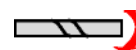

**Bending strength** - resists bending - is **rigid**. e.g. woods



**Malleability**

is a measure of how easily a material can be permanently deformed by compressive forces. e.g. hammering, without cracking

THERMAL EXPANSION	MATERIAL
High	Copper Aluminium
Medium	Mild steel Bronze
Low	Woods Thermoset plastics

**Ductility**

is a measure of how easily a material can be permanently deformed, without cracking or breaking, by bending, stretching or twisting.

DUCTILITY	MATERIAL
High	Polypropylene Copper
Medium	Mild steel Bronze
Low	Woods Thermoset plastics

**Hardness**

is a measure of how well a material resists scratching and being worn away by other materials

HARDNESS	MATERIAL
High	Diamond Chromium
Medium	Mild steel Bronze
Low	Woods Thermoplastics

**Toughness**

is a measure of how well a material can stand up to sudden forces, e.g. a hammer blow, without cracking. A material that is not tough is called **Brittle**

TOUGHNESS	MATERIAL
High	Polycarbonate Copper
Medium	Mild steel Brass
Low	Glass Polyester resin

**Durability**

is a measure of how well a material stands up to weathering (the sun, cold, wind, rain, corrosion and rotting)

DURABILITY	MATERIAL
High	Gold Tin
Medium	Ceramics Bronze
Low	Mild steel Soft woods

**MATERIALS TESTING**

In industry, materials are put through a series of tests to test all of the properties mentioned in this chapter to see if they are suitable for the product being designed. Special machines are used to test tensile strength, brittleness and hardness etc. In school you can still carry out basic tests to check that your choice of materials is suitable.

**Bending strength (rigidity)**

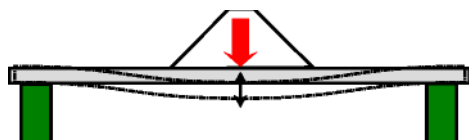

Cut identical lengths (samples) of the materials you wish to test and place each over the same length gap. Place the

same weight over the middle and measure the amount the sample has bent from the horizontal. The most rigid will have moved the least.

**Toughness**

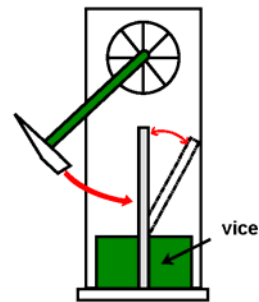

Use identical samples of different materials, place in the vice and lift the suspended hammer to the same height each time. Let it go and then measure the angle that the sample has been bent to. The smaller the angle the tougher the material.

**Hardness**

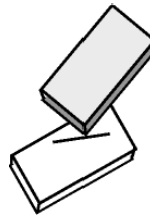

Find samples of each material, they do not have to be identical, just have a sharp corner. Then use each sample in turn to try and scratch the other samples. The hardest is the one that all the other samples cannot scratch. Using this method you can put the samples into rank order of hardest to softest.

**KEY WORDS Density: Fusibility: Conductivity: Insulating: Malleability: Ductility: Deformation: Toughness**

1. Define the term 'density' and give two examples of a dense material.
2. How would you describe a fusible material? Give two examples of easily fused materials.
3. Give two examples of materials that are good heat insulators.
4. If I wish to make switch contacts that will conduct electricity well, which materials might I use?
5. What do you understand by the term 'translucent'?
6. Explain what an elastic material is.
7. With the aid of diagrams, explain the terms 'tensile strength', 'shear strength and 'bending strength'.
8. What property allows a material to be stretched until it becomes a long thin wire or fibre?
9. What is the property that makes a material a malleable material?
10. Explain what is meant by a 'tough' material. Describe the sort of materials that are the opposite of tough.
  - A Describe, with the aid of diagrams and notes, a test that you could carry out at school to measure heat conductivity in different materials.
  - B Describe, with the aid of diagrams and notes, a test that you could carry out at school to measure the durability of different materials in water.
  - C What are the properties required by the materials that are used to make a garden fork. Take each part in turn (handle, shaft and the fork head), state what you think they are made from and then list their properties.



**ERGONOMICS**

Every well designed product must be easy, comfortable and safe to use. The parts of the product that are touched by humans, e.g. handles, seats, table tops etc. are said to be **ergonomically designed**. Not every part of a product needs to be ergonomically designed, e.g. the parts inside a DVD player are not normally touched by the user so do not need ergonomic design.

**Designing Handles Ergonomically**

A designer who is working on a handle needs to consider the following:

Is the handle wide enough to be comfortable to use, without being too wide so that it is difficult to grip and could slide out of the hand?

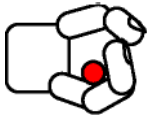
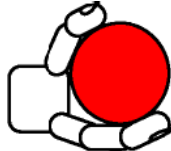

Or is it too narrow, so that it cuts into the fingers and cuts off the blood supply?

Or is it just right so that the user can get a good firm grip and hold it comfortably and safely?

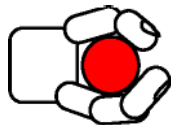

Is the length of the handle long enough to allow all four fingers to fit into it without squashing them?

Or is it too long so the hand can slide to one end and not hold the object level?

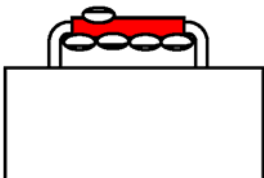
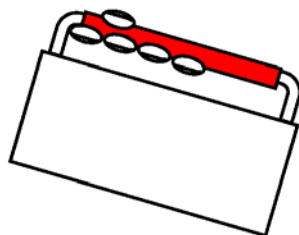

Or is it just right so that the fingers fit without being squashed and the handle ends stop any sliding?

If the handle has to be long, then sliding can be stopped by using a slip resistant material such as soft rubber, or by shaping the handle.



Slip resistant handle shapes

**ERGONOME**

When a designer is working on large products, such as furniture, they often use a stylised scale drawing or 3D model of the human body called an **ergonome**.

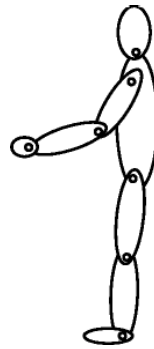

This diagram shows an ergonome made from pieces of card. Each of the pieces are loosely pinned to each other so that the body can be placed in various positions. e.g. sitting on a seat.



If the ergonome above is printed on an A4 sheet it will be at a scale of approximately 1:35

**ANTHROPOMETRIC DATA**

A designer needs to make sure that the sizes chosen for a design are ergonomically correct. To do this the designer will look up **anthropometric data**.

The data is a series of tables showing measurements from all parts of the body, for men, women and children of various ages. A lot of people were measured and their results were pooled together to provide the data.

Most designers of popular products only consider 90% of the population, the smallest 5% and the largest 5% are not normally catered for, and rely upon specialist designs, e.g. shoes larger than size 14 are normally handmade to order and cost a lot of money.

To help tell the difference between the smallest 5% and largest 5%, anthropometric tables use the term **percentiles** instead of percentages and give three columns of information for each measurement.

e.g. For the standing height measurement of adult men **5th percentile** - 5% of the population are 1644mm tall, or smaller

**50th percentile** - 50% (half) of the population will be 1753mm tall, or smaller.

**95th percentile**- 95% of the population will be 1861mm tall, or smaller.

Measurement	Subject	5 <sup>th</sup> Percentile	50 <sup>th</sup> Percentile	95 <sup>th</sup> Percentile
standing height in mm	adult male	1644	1753	1861
	adult female	1517	1626	1734
handle diameter in mm	all adults	40	45	52

**A** Using a school chair, or a dining room chair at home, identify the parts that should be ergonomically designed, (use diagrams and notes). Also, draw a sitting ergonome and show which measurements need to be made to help the designer make the chair comfortable to use by 90% of the population.

**KEY WORDS** Ergonomic: Anthropometric: Percentile: Ergonome



## COMMERCIAL PRODUCTION

Most products are produced in large numbers, each being identical to the planned design. Dimensional accuracy is very important, especially when parts have to fit together. When a product is being handmade as a one-off, a common cause of error is incorrectly measuring when using a ruler. When a product is produced by mass or batch production methods, the need to measure using a ruler is removed by the use of **Templates** and **Jigs**.

The template can also be used to save on waste when marking out a number of identical shapes on a sheet of material. When the shapes are drawn linked together, they are said to be **tessellated**.

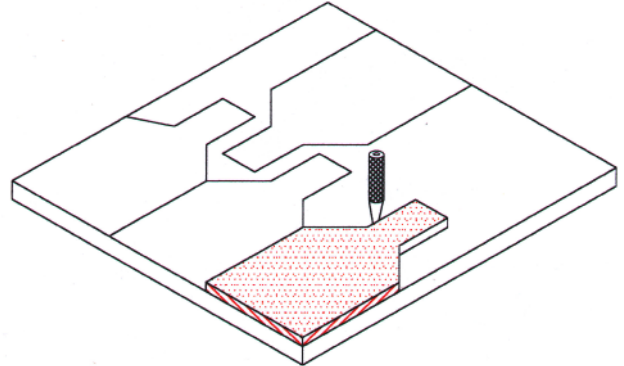

## TEMPLATES

A template is an accurately formed shape, made from a rigid material. The template can be drawn around or followed repeatedly without wearing.

Templates can also be used during the production process to guide a cutting tool.

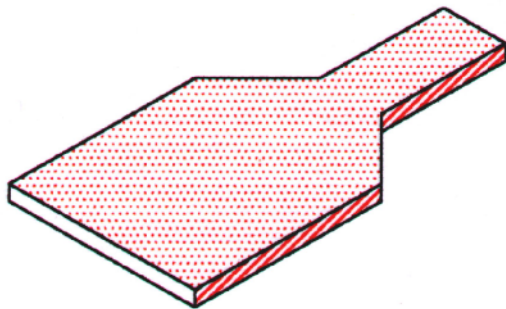

A template made from hardboard, used to mark out the ends of a bottle carrier.

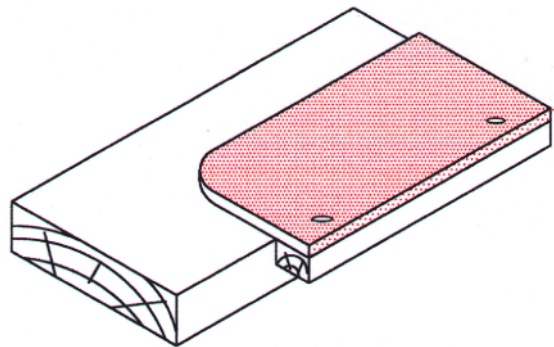

A plywood template can be used to guide the cutting of a groove, using a router.

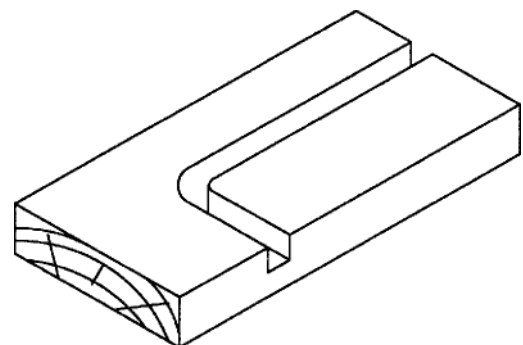
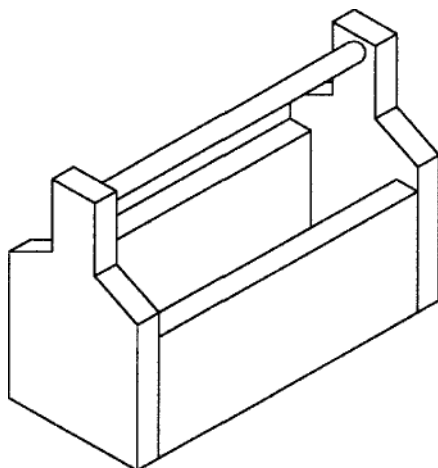

**JIGS**

Jigs are used to ensure that dimensions are always accurate. They are particularly useful when the positioning of holes and bends are important. They are designed so that they either hold the workpiece in the correct position or guide the cutting tool into the correct position. It should be possible to line up the jig with the workpiece and clamp them together to stop slippage.

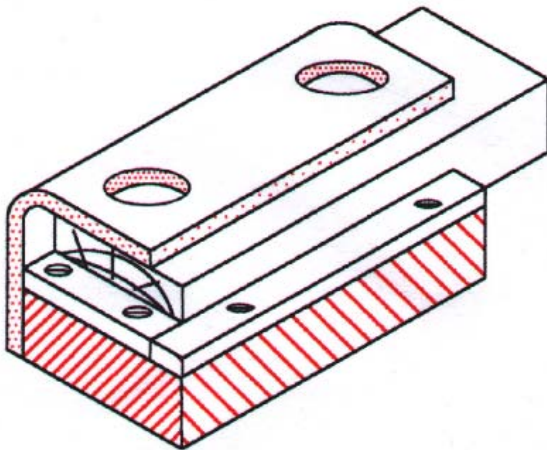

A school-made jig for lining up holes when making dowel joints.

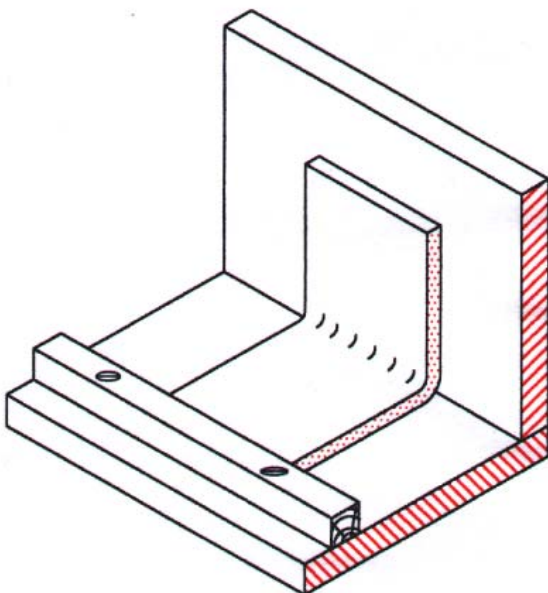

A jig for bending heated plastic sheet in the correct position every time.

Below is a jig used for bending steel rod to make junior hacksaw frames. The jig is made from mild steel. The pins are removable to allow the rod to be bent into position. The pin for the end of the handle is shown removed from its locating hole.

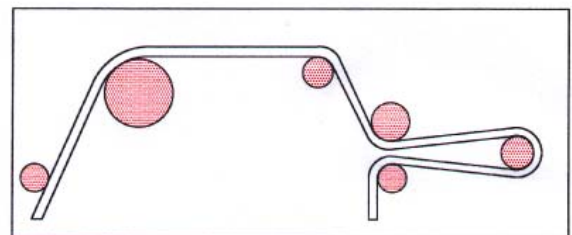
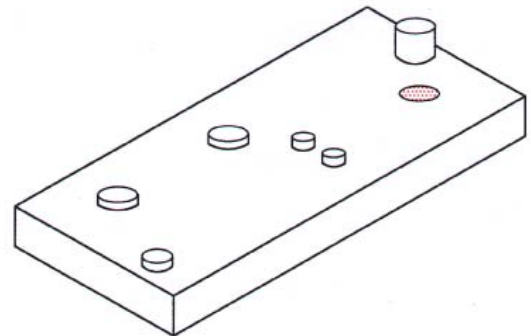

The completed frame

1. Give an example of when dimensional accuracy is important.
  2. What is a common cause of error when products are handmade?
  3. Describe a template.
  4. Show a template being used to draw tessellations (draw your own example).
  5. Apart from drawing shapes, what else can a template be used for?
  6. Why is a jig used?
  7. Give two examples of what a jig can be used for.
  8. What can happen that stops a jig being an accurate guide?
  9. Why are some pins removable in the junior hacksaw frame bending jig?
  10. What material is the hacksaw frame bending jig made from?
- A.** Design a jig to line up the hole used to locate the handle in the ends of the bottle carrier. (shown in the first column). Show how the jig will locate with the end piece and be held in place. Name the materials used for the jig.
- B.** Design a jig, or jigs to allow the correct bending of sheet acrylic to produce the recipe holder shown.

Height 200mm  
Width 180mm  
Depth 200mm

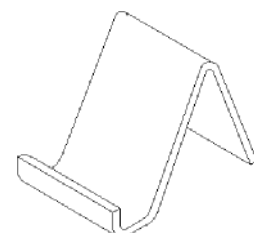

**KEY WORDS** Template: Tessellation: Jig:

## CAD/CAM

CAD/CAM stands for **Computer Aided Design / Computer Aided Manufacture**. This is the process whereby the product is designed using a computer, and the machines used to make it are controlled by a computer. Drawings and instructions written on pieces of paper are not required.

### Computer Aided Design

Computer programs can be used to draw accurate, scaled drawings of the design of a product in both 2D and 3D.

In 2D, dimensions can be added automatically and drawings of parts that are used a lot, such as nuts & bolts can be inserted like clip-art, from a drawings bank. In 3D, rendering (colour & texture) can be added as well as highlighting and shading. The view can be made to twist and turn so that it can be viewed from any angle.

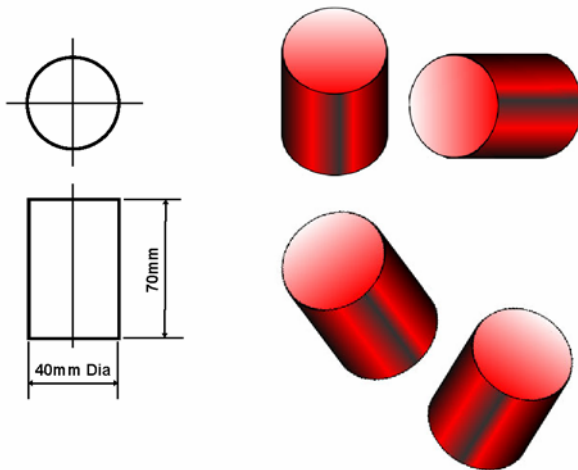

In industry, powerful programs can be made to animate moving parts and to work out the forces that the part will have to stand up to, so that it does not break in use. This can save hours of testing prototypes.

### Advantages

Some of the advantages of using CAD are:

- Faster accurate drawing
- Drawings of common parts can be inserted from a drawings bank
- Changes can be made quickly and easily
- Dimensions can be added automatically
- Printouts can be to any scale In 3D, the object can be viewed from any angle

### Disadvantages

Some disadvantages of using CAD are:

- The cost of the computer and programs
- Early ideas are recorded faster by sketching
- A pad of paper and a pencil can be used anywhere

## Computer Aided Manufacture

Computers can control cutting machines such as drilling machines, lathes, milling machines etc. The computer controls the movement of the cutter very accurately (accuracy to 500th of a millimetre is possible).

In the CAD/CAM system, data from the CAD drawing is downloaded to the CAM program which is then used to control the cutting machine.

A computer can also be used to control the handling of the parts to be cut from one machine to another.

Computer controlled fabrication (joining parts together) is also possible. Parts can be automatically held together in the right positions, while they are welded, riveted or glued by computer controlled equipment.

Injection moulding, compression moulding, vacuum forming and extrusion of plastics can all be done by computer controlled machines.

### Advantages

Some of the advantages of using CAM are:

- Very accurate work
- The machine does not need breaks
- The machine does not get tired and inaccurate
- Changes of design can be made quickly

### Disadvantages

Some disadvantages of using CAM are:

- The cost of the computers and programs
- The high cost of the machines
- The loss of jobs

## KEY WORDS CAD: CAM: 3D: 2D: Animate: Commercial Production

1. What does the term 'CAD/CAM' stand for?
2. State **two** things that can be done when drawing with a CAD program that cannot be achieved when drawing on paper.
3. List **three** advantages of using CAD.
4. List **two** disadvantages of using CAD.
5. What else can an industrial CAD program do as well as draw?
6. Name **four** machines that a CAM program can control
7. How accurate can a computer controlled cutting machine be?
8. Name **two** processes other than cutting, that can be carried out by computer controlled machines.
9. List **three** advantages of using CAM, rather than human controlled machines for manufacture.
10. List **two** disadvantages of using CAM.
  - A. Manufacturers of DVD systems, computers and TVs, etc. can change their models every month. Explain what part CAD/CAM plays in this rapid turnover.

## MANUFACTURING SYSTEMS

There are **three** main production systems:

**Mass Production** - is used where there is a continuous demand for large quantities of a product. e.g. tin cans for food, cars, etc. Sometimes called **flow production**, this system is organised so that specially designed machines carry out one operation on the product, that is continuously passed from one different machine to the next, until at the end of the line it is complete and finished.

### Advantages:

- Low production costs, if sufficient products are made.

### Disadvantages:

- Models cannot be changed easily. If one machine breaks down the whole line is affected.
- The machines cannot be easily reset to make other models.
- The machines cost a lot to purchase when the line is being set up.

**Batch Production** - is used where the need for a product is not continuous, or not enough are sold to make mass production worthwhile e.g. room heaters, and one style of calculator. Batch production often looks like mass production, but it uses machines that can be altered to make another model, or something completely different. e.g. The machines may be set up to make one model of heater for one month and then production is stopped while the machines are reset to make a different model for the next month.

### Advantages:

- Flow production methods lower the production costs.
- Model changes can be made regularly, upon change over.

### Disadvantages:

- No production occurs while machines are being reset, this adds to the cost.
- The products need to be stored until there is a demand for them.

**One-off** - Producing one product at a time. This method is often used by traditional craftsmen and artists, who work to order, e.g. high quality musical instruments and sculptures are made this way.

### Advantages:

- The customer gets a product that is designed exactly as they wanted it.
- Quality checks can be made at every stage of manufacture.

### Disadvantages:

- The production method is slow and very costly.

## COMPUTER INTEGRATED MANUFACTURING (CIM)

Many people in different departments are involved in making even the most simple of products such as a ruler. Each department uses computers, the CIM system links all the computers, so that everyone involved can see what is happening, with regard to the product, in the other departments.

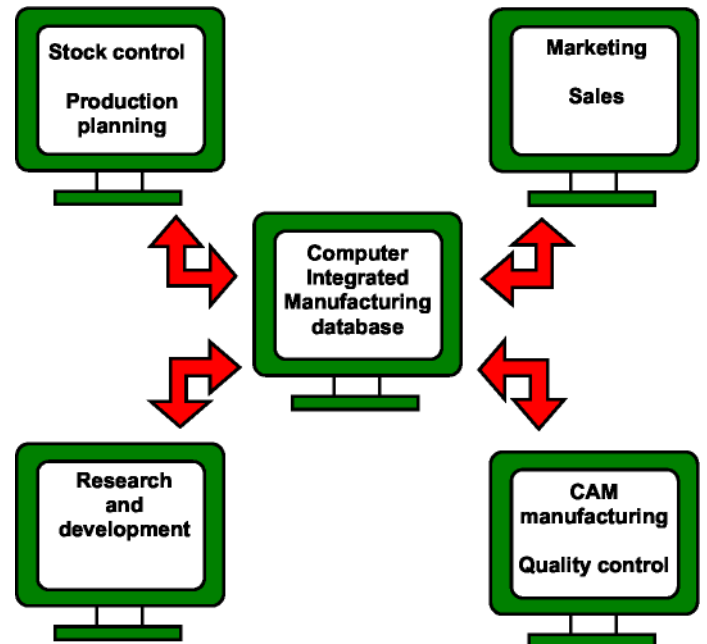

Because the computers are all linked, any changes such as a design alteration will automatically affect the ordering of materials, the production plan, the quality control system and maybe even the packaging of the product. Everyone who needs to know will know immediately of any changes that affect their work.

### KEY WORDS Mass: Batch: One-off: CIM: Commercial Production

1. Explain the term 'one-off' production.
  2. List the advantages and disadvantages of one-off production.
  3. Explain the term 'batch' production.
  4. What are the advantages and disadvantages of batch production?
  5. Explain the term 'mass' production.
  6. What are the advantages and disadvantages of mass production?
  7. What is meant by the initials 'CIM'?
  8. Give **four** examples of the sort of links that can be made using CIM.
  9. What is the main advantage of using a CIM system?
  10. What manufacturing system would you use to make a fitted cupboard to go under the stairs?
- A** List **four** products found at home and state which manufacturing system you think were used to make them.



## QUALITY

When a product is described as a high quality product it means that it is designed:

- to do what it is meant to do excellently
- to last a long time
- to need little maintenance.

High quality products normally cost more, one reason for this is that more money is spent in inspecting every part as it is being made and put together. The purchaser is willing to pay more to be sure that the product will not fail early on in its life.

### Consumer Confidence

To help a consumer be sure that what they are buying is of good quality, independent standards organisations publish lists of standards of quality that the product must meet. If a product fully meets the standards, then the manufacturer can apply to the organisation to be allowed to have the organisations logo (known as a **kite-mark**) displayed on the product. If a consumer sees the kite mark on the product then they can be sure that it is safe to use and should work for a reasonable length of time.

The two most common kite-marks found on products in Britain are those of:

The **British Standards Institute**



The **European Commission**



### Quality Assurance

Many companies want to get a reputation for high quality and wish to keep it. To help do this, the company can organise itself so that every employee tries to work with quality in mind, including those not directly involved in the making of the product, such as managers and office staff. When a company has done this, they can apply to be inspected to see if they are good enough to be awarded the **ISO 9001**. This is given by the International Standards Organisation to companies with a high standard of **Total Quality Management (TQM)**. These companies often organise their employees into small groups called **Quality Circles**, who meet regularly to discuss how the quality of what they do can be improved.

### Quality Control

Even if every employee is working to a high quality standard, the machines making the product can go wrong and produce a poor quality output. To guard against this, computer controlled inspection equipment can inspect each part as it comes off the machine. This is called **Process Control**. The inspection equipment can warn the machine

operator as soon as the quality of the parts begins to fall. Process control is costly, so many manufacturers rely upon inspecting the parts manually at regular intervals. For example, every 100th part can be removed for inspection.

### Inspection

- A part needs to be inspected for:
- Accuracy of its dimensions
- Faults in the material (cracks, splits etc.)
- Its surface finish (e.g. rough instead of smooth)
- Its appearance (e.g. is the colour the correct shade?)

### Dimensional Accuracy

Although Computer Aided Manufacture can produce parts very accurately, there will still be small variations in the dimensions. Problems arise when one part has to fit into another part. For example, the wheel of a shopping trolley has to fit onto an axle. If the axle diameter is too large, the wheel will stick and not turn easily; if it is too small then the wheel will lean over and the hole in the middle of the wheel, known as the 'bearing', will wear away quickly.

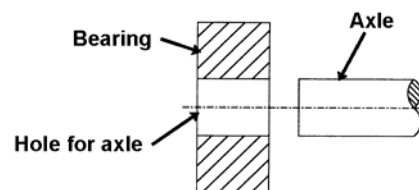

The dimensions do not have to be exact however, if the axle is just a little large or small, then the wheel bearing will still work perfectly. The amount that a dimension can vary without affecting performance is known as the **tolerance**. A dimension showing tolerances normally shows how much larger it can be by using a '+' sign and how much smaller it can be by using a '-' sign. If an axle should be 15mm diameter if perfect (this is known as the **nominal size**) but could be 0.1mm larger or 0.2mm smaller and still work well, then the dimension will be written in the following way.

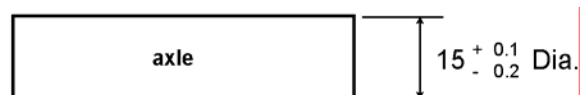

Any axle that is too large or too small will be scrapped and hopefully recycled.

Tolerances can also be given for:

- Lengths, widths and depths.
- Positions of holes and their diameters.
- Angle measurements (in degrees).
- Surface flatness and smoothness.

**KEY WORDS** Kite-mark: Quality control:  
Nominal: Tolerance



**STATISTICAL QUALITY CONTROL**

Checking each part of a product every time it is manufactured costs a lot of money and is normally only considered for the most expensive, top of the range products.

Normally, only a selection of parts are tested and the results are added to a graph to see if there is a trend showing that will eventually lead to the part being too large or too small.

e.g. The diagrams below show one end of a wooden curtain rail. The end-stop slides onto a round wooden rail. The hole that the rail fits into must be a tight fit and within diameter tolerances. The end-stop is turned on a computer controlled lathe.

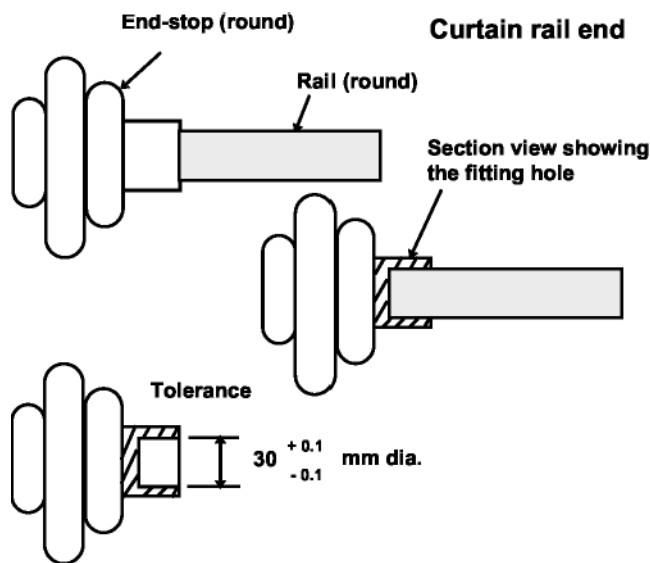

The production manager decides to check every tenth end-stop and plots the data on a graph.

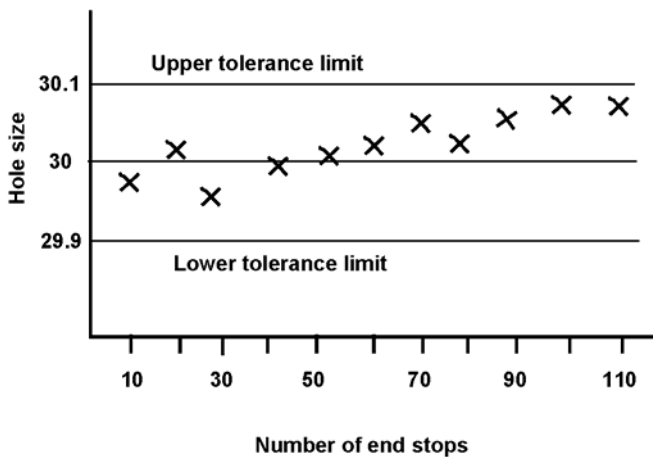

It can be seen from the graph that there is a trend for the hole to get larger, so it would be a good idea to reset the machine before the hole gets too large and the end-stops have to be rejected.

**INSPECTION GAUGES**

A quick and accurate method of checking to see if a component (part) is too large or too small is to use a 'GO - NO GO' Gauge

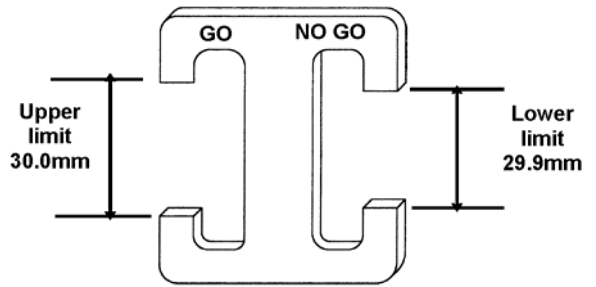

**To use the gauge - On the rail**

1. Check the the 'GO' side to see that it slides over the rail. If it doesn't, then the rail's diameter is too large.

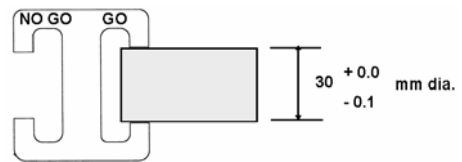

2. Turn the gauge round and check that the 'NO GO' side will **not** slide over the rail. If it does, then the rail's diameter is too small.

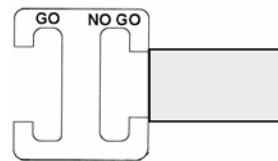

For checking the hole in the end-stop, a **Plug Gauge** can be used in the same way.



1. What qualities must a high quality product have?
2. Sketch two examples of a quality kite-mark.
3. Explain the term 'Total Quality Management'. What will a successful company be awarded?
4. Why do manufacturers need quality control procedures?
5. Explain fully what is meant by the term 'tolerance' in manufacturing.
6. Name **four** things that tolerances can be applied to.
7. Why isn't every part of every product tested before it is assembled together?
8. How can statistics help reduce the number of reject parts?
9. Sketch a 'GO - NO GO' gauge and show how it is used.
10. Sketch a Plug gauge and show how it is used.

## RECYCLING

Recycling is processing old material to make it good enough to be used as new, e.g. melting down used aluminium drinks cans so that new cans can be made without using fresh aluminium. Sometimes the old material is added to the new. Most 'new' steel contains up to 40% melted scrap steel.

**Plastics** - most thermoplastics can be recycled, e.g. 'PET' used for fizzy drinks bottles is recyclable. Thermoset plastics are not recyclable.

**Metals**- Pure metals can be recycled. Alloys can only be effectively recycled if all the scrap is the same alloy.

**Wood & Ceramics**- are not recyclable.

Products that are made of material that can be recycled will normally display the three arrow symbol on the label.



Recycling is part of the government's drive to reduce the amount of waste in this country. The aim is to reclaim and re-use as much material as possible. However, this is not always possible, some materials e.g. ceramics, cannot be recycled, but can be used for other purposes, e.g. old ceramic products are used as hard-core, a layer of broken ceramics and bricks, onto which concrete is poured to make pathways, etc.

The government's policy can be called the '4Rs' policy.

**Reduction** - Reduce the production of waste in the first place.

**Re-use** - Clean and re-use products, e.g. bottles.

**Recover** - Recycle paper, glass, cloth, steel and aluminium, etc.

**Remove** - Remove as little as possible and try and gain energy from burning the waste or collecting methane gas from a landfill site.

**Life Cycle Analysis (LCA)** This analysis process involves collecting data at each stage of the manufacture and use of a product, from the extraction of the raw materials, to the problems it produces when it is thrown away at the end of its life. The data is about:

1. The cost of getting the raw material e.g. digging metal ore from the ground.
2. The cost of converting the raw material into a usable material, especially how much energy was used (electricity, coal, gas or oil).
3. How much recycled material was used in making the product.

4. How much time, energy and waste was involved in each making process.

5. How much material, time and energy was used in packaging the product and distributing it to the shops.

6. How easily it can be disposed of safely, or used for recycling at the end of its useful life.

LCA can be applied to the manufacture and use of a computer.

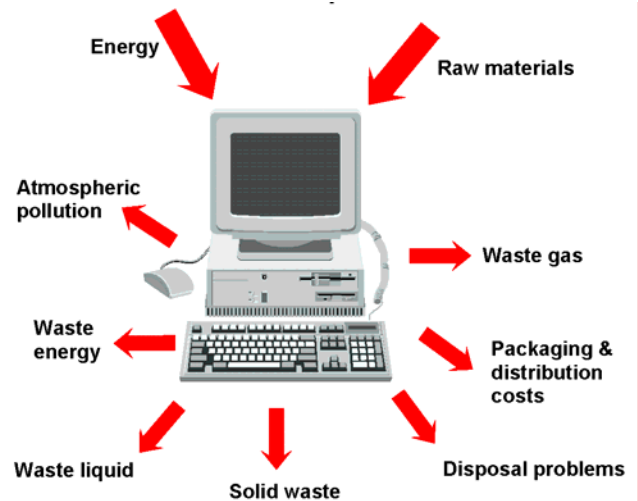

The aims of responsible manufacturers are:

- A) To reduce the amount of energy used in manufacturing the product.
- B) To make a product that lasts a reasonably long time.
- C) To make it as recyclable as possible when it is worn out, or out of date.

Recyclable packaging



1. What do you understand by the term 'Life Cycle Analysis'?
2. How would you identify a responsible manufacturer?
3. What is the difference between the terms 'recycled' and 're-used'?
4. A clear glass jam jar is to be recycled. What would you expect to happen to it?
5. What is the government's policy about reducing waste and energy use?
  - A. Identify **four** products that are used at home that could be recycled. Say what they are for and what material you think they are made from.
  - B. Identify **four** products that are used at home that could be re-used, either for their intended use or for an alternative use. State how they could be re-used.

## PROBLEM ANALYSIS

### The Problem

Every product is designed, made and sold to solve a problem. A new design may be needed because:

- A new problem needs to be solved. e.g. storing three or four remote controllers so they don't get lost in the lounge.
- New technology makes the old design obsolete e.g. new computers and mobile phones are launched every week or two.
- Fashion changes and 'old' styles don't sell e.g. manufacturers regularly change the case design of personal CD players.
- Novelty - a manufacturer needs their product to be different from their rivals e.g. a mobile phone that is also a radio.

Often a company will carry out **market research** to see if there is a need for the product they intend to design and manufacture. One way of doing this, is by asking the general public to answer a questionnaire containing questions about the problem and what they see as a possible solution. The questionnaire can be based around the five 'W' questions

For example, if a company marketing department was tackling the problem of providing a storage system for remote controllers, they might write a questionnaire asking:

**WHAT** is the situation? e.g. What happens to the controllers without storage?

**WHY** does this cause a problem?

**WHEN** does this cause a problem? e.g. Is the user likely to be standing or sitting at the time?

**WHO** does the problem affect? e.g. Who will want to find the controllers quickly?

**WHERE** will the solution be used? e.g. Which room and where in the room?

They will then write a design **brief** based upon the results of the questionnaire. A brief is a short statement explaining the problem and suggesting a possible solution. The design brief is then given to a designer.

The designer should look at the brief and link it to the results of the questionnaire.

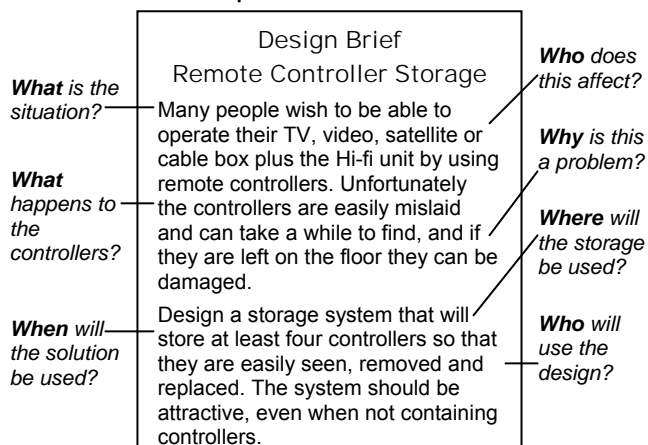

At this point the designer will need to carry out further research:

- Analyse rival products (construction, materials used, cost etc.).
- Investigate new technology and new materials that might be used.

Check fixed data. e.g. the dimensions of the largest and smallest remote controllers.

## MARKET RESEARCH

A market research questionnaire for the remote controller storage problem might look like the example below.

### Remote Controller Storage Questionnaire

- How many remote controllers do you use?  
None  1  2  3  4  5  More
  - How many do you use in one room?  
None  1  2  3  4  5  More
  - Which room do you use them in?  
Lounge  Dining room  Kitchen   
Bedroom  Study
  - Would you be interested in a container that conveniently stored the controllers between use?  
Yes  No
  - What price range would you consider?  
£2 - £5  £6 - £10  £11 - £15   
£16 - £20  More than £20
  - Which material would appeal to you most?  
Wood  Plastic  Metal  Combination
- Etc.

When a sufficient number of questionnaires have been answered, (in school this would be between 10 and 20) the results will need to be presented. These can be in two forms.

(a) A user specification - a list of the most popular answers.

(b) Graphs or charts showing the number or percentage of people giving each answer.

- List four reasons for creating a new product design.
  - What is meant by the term 'Market Research'?
  - List and explain the five 'W' questions.
  - What is a design brief?
  - What other research does the designer need to do?
- A** Write a design brief for either storing up to 50 CDs, or a jewellery collection, or a product of your own choice.
- B** Write a market research questionnaire for the examples given in A.

## DESIGNER SPECIFICATION

When the market research results have been presented and the brief written, and any other research completed, it is the designer's job to write a **designer specification**. The Designer Specification is a list of all the factors that must be right if the design is to be successful. The easiest way to compile the list is to consider each of the headings shown below. Some will be relevant to your project, others will not; they can be tackled in any order. Where possible, justify your decisions by referring to your Market Research data and User Specification.

**FUNCTION** - *What is it that the design must be able to do? Will the design have to be ADAPTABLE in order to do more than one job or will the design have to be capable of changing its size to fit different people?*

**SHAPE** - *Will the design have to be a definite shape? If so, what is it?*

**SIZE** - *What are the largest and smallest dimensions that the design could have? Does one part have to be in PROPORTION to any other part?*

**AESTHETICS** - *Is the appearance of the design important. Does it have to be in a certain STYLE? Does it have to be appealing to certain members of society, e.g. children?*

**STORAGE** - *When not in use how will it be stored? Will the need for storage affect the design?*

**MANUFACTURE** - *Will the tools and machines required to make the design be readily available in school or will help from other sources be needed?*

**MATERIALS** - *What are the properties that the chosen materials should have? e.g. weight, rigidity, conductivity, hardness, colour etc.*

**FINISH** - *What are the qualities that the chosen finish must have? Will the design be used outside or be used by children*

**SAFETY** - *Is the design going to have special safety requirements? Are parts of the design likely to scratch, cut or pinch if poorly designed?*

**ERGONOMICS** - *Do parts of the design need to fit human sizes, e.g. will the design include handles, or seating or work tops? What are the human measurements that the design will have to fit? (anthropometrics).*

**COST** - *What is the maximum cost of both materials used and time taken, in completing the project that you can allow?*

**POLLUTION** - *Is the design likely to harm its surroundings in any way? e.g. scratch the surface that it sits upon.*

**MARKET** - *What are the requirements of the people who are likely to use the design? Are they young, old, male or female, fit or handicapped, etc.?*

The designer specification should be checked regularly throughout the rest of the design process to make sure that the final result meets the needs of the consumer. In industry the specification would include a list of all the quality and safety requirements.

A designer specification for the design of a container to hold remote controllers for TV, video etc., might look like the following example.

### Designer Specification Remote Controller Storage

**Function:** *The container should be capable of holding up to four remote control units. They should be easy to see and be removed and replaced with ease. (taken from market research)*

**Shape:** *There is no set shape.*

**Size:** *The compartments should not be smaller than 60mm long by 30mm wide and 40mm deep. The largest depth should be no larger than 100mm. It should look stable. (taken from controller size data)*

**Aesthetics:** *The container should look interesting even when empty. The style should be modern or futuristic. There are no colour restrictions. (taken from market research)*

**Materials:** *The materials should be light in weight but sturdy enough to take the weight of the controllers.*

**Finish:** *The finish should be scratch resistant. The texture should not be too rough and be easy to clean.*

**Safety:** *It should be comfortable and safe to pick up and move. There should be no sharp corners or projections. (taken from safety standards)*

**Ergonomics:** *Any handle should be at least 100mm long on the inside and at least 20mm diameter in the middle. (taken from anthropometric data)*

**Cost:** *The cost of manufacture should not be more than £5. (taken from market research)*

**Pollution:** *The base should not scratch any surface that it is placed upon.*

**Market:** *The design should appeal to the 20 to 40 age group. (taken from market research).*

**PRODUCING IDEAS**

Once you have understood your brief and completed the research you can think about different ways of designing the product.

Ideas can come quickly and you want to be able to draw them fast so that you do not forget the detail of the idea before the drawing is finished. The fastest way of drawing is freehand sketching with a pencil, because you can put things down on paper as soon as you think of them. A computer drawing program is not so good because you have to think about how to get the effect you want and this slows down the process and distracts your train of thought.

**Method**

It is very easy to make a sketch to look twisted and out of proportion. To avoid this, it is best to start by **crating** the drawing. If you are sketching in 3D then there are two common drawing systems that you can use, one is called **Isometric** and the other **Oblique** (note: the angles of the lines)

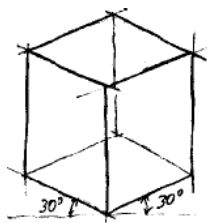

An isometric crate

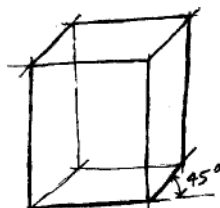

An oblique crate

When you have drawn the crate lightly then the shape of the object can be drawn inside.

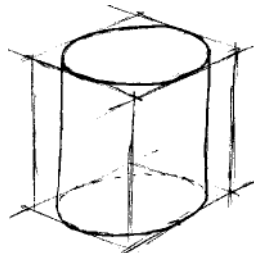
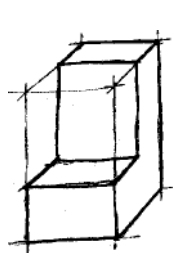

The unwanted light crate lines can then be carefully rubbed out, leaving the heavier lines of the shape you want. You will often have to go over the heavy lines again to make them clear and restore any rubbed out bits. Colour, highlighting and shadow can also be added.

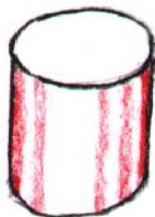
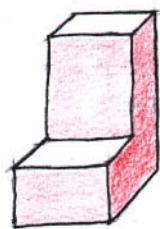

Your ideas pages should show your train of thought. When you have sketched an idea, analyse it and note down your thoughts next to the drawing. Try and link your ideas by making a series of changes to the original.

The following shows a typical ideas page for a remote control storage system.

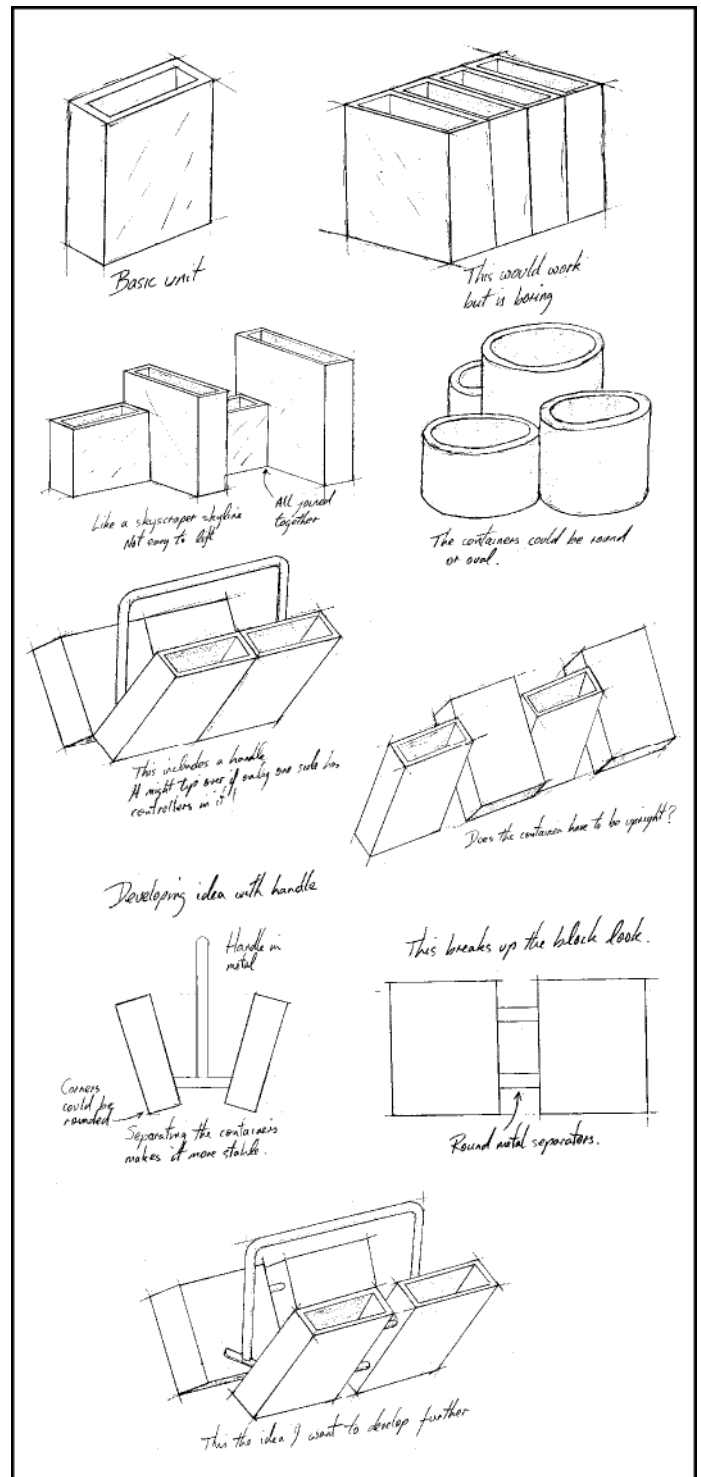

The chosen idea can now be developed further by considering materials, dimensions, finishes and construction techniques.



**DEVELOPING YOUR CHOSEN IDEA**

Developing your idea can be split into two types of action

1. Trying out small changes to your chosen idea, to improve it e.g. rounding off corners, changing some dimensions to check the proportions, trying different colour combinations
2. Researching possible materials to use, shaping methods, jointing methods and finishes, and then choosing which you are going to use. To help you choose, you can carry out a series of tests on different materials, joints and finishes.

**Development 1**

The changes that you try out can be made by further sketching or by modelling (see worksheet 10e)

The example below shows curved corners on each of the remote controller containers, instead of the sharp corners of the original idea. If you don't like the change then go back to the original idea.

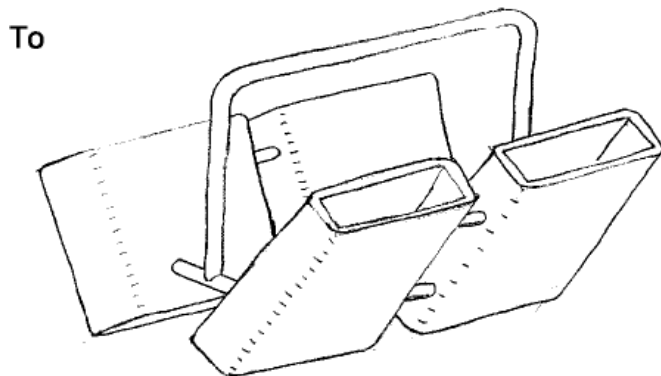
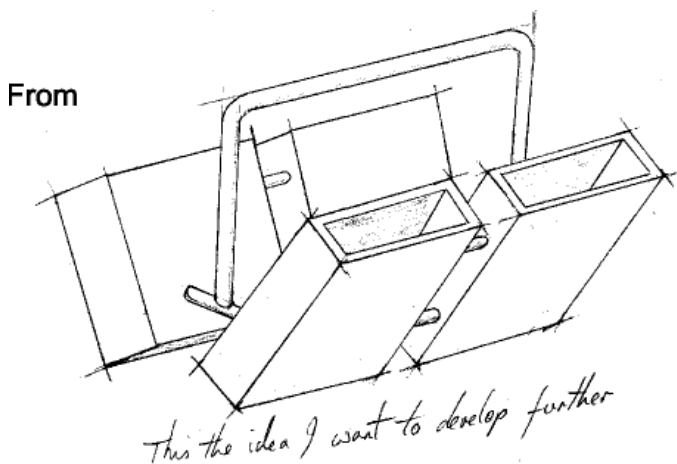

**Tip:** To save time, place a new piece of paper over your original drawing and hold it down with paper clips or masking tape and then trace the lines that are not going to be altered. Using a lightbox would make this even easier.

**Development 2**

Do not waste your time by researching all materials and joints etc.

**Materials**

First, find out which materials are available in the school workshop or can be purchased locally and then use a textbook or computer program to tell you what properties each material has.

Consider only those that appear to have the properties your design needs.

To help you make a final choice, ask for a sample of each possible material. These can then be tested for weight, rigidity, hardness, toughness, texture, etc. (see worksheet 5b)

Write up your tests with the results and present your work in the 'development' section of your design folio.

**Joints**

In most textbooks the joints are normally grouped together depending upon the material; wood, metal or plastic and the type of construction; framework, carcass or sheet. This helps you to narrow down the number of possible joints that you could use.

Before making a final choice, try making your chosen joint using spare material of the same type that you have chosen to use.

e.g.

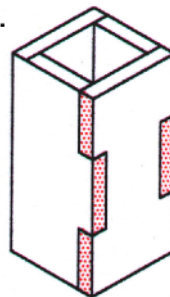

The 'Finger joint' for this tall container made from MDF may look interesting, but it is difficult to cut and fit together without any gaps.

The 'Rebate joint' is a lot easier and faster to cut if a rebate plane is used and gaps are less likely to be a problem.

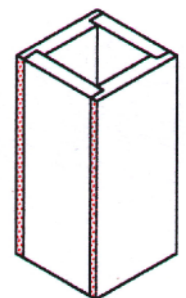
**Finishes**

It is also worthwhile doing some trial painting or varnishing on samples of the correct material. Paint colours can look different on different surfaces. Varnishes can be less or more glossy on different surfaces.

On metals you may want a shiny or a brushed finish (made by rubbing with emery cloth in one direction only). Try it out!

**Remember** - Keep all your tests and trials for marking at the end of the project.

## MODELLING IDEAS

Models are made to test ideas. Often only the part of the product that needs to be tested is modelled, e.g. If a simple box is to be lifted by a handle, only the handle shape needs to be modelled to test it for size and comfort.

### Model vs Prototype

A **prototype** is what you make at the end of the project, using the correct sizes, materials, joints and finishes and it should fully work.

A **model** is often made to the wrong size, with the wrong materials and doesn't always need to work.

### Scale

Models are often made smaller or larger than the product they represent. This is known as a **scale model** and is often referred to as half scale, if it is half the size of the product, or maybe 1/5th scale if every dimension is 1/5th of the full-size product, etc.

### Testing

It is important that you are clear about what you want to test before you make a model. Models can be used to test:

- Dimensions
- Proportions
- Colour scheme
- Mechanical system (e.g. folding legs on a picnic table)
- Feature positions (e.g. buttons on a mobile phone)
- Shape
- Attractiveness
- Stability

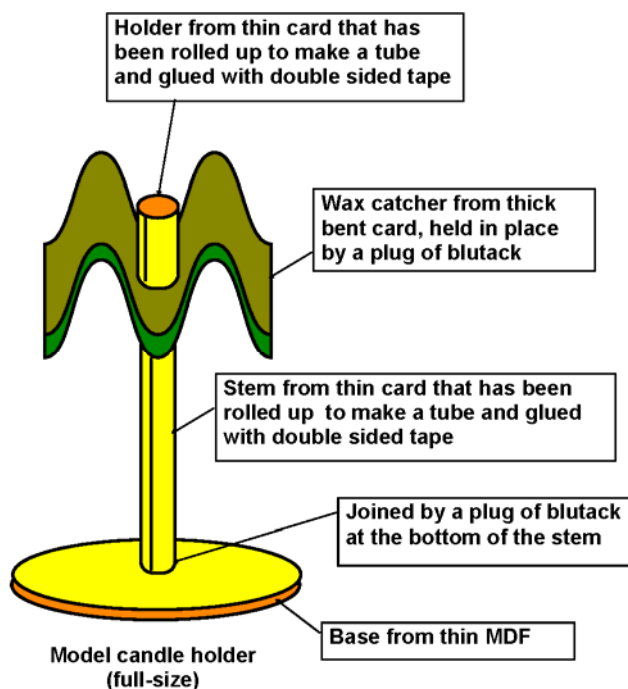

Models should be quick to make and made from cheap materials.

### Useful Model Making Materials

- Paper
- Card
- Cardboard
- MDF
- Plywood
- Balsa wood
- Rigid foam
- Polymorph plastic
- Wire
- Welding rod
- Matchsticks (without heads)
- Lollipop sticks
- Clear plastic sheet
- Drinking straws
- Clay

Joining methods should also be quick and simple.

- Glue gun adhesive
- Double sided adhesive tape
- Split pins
- Blutack
- PVA adhesive
- Velcro
- Pritt-stick

### Computer modeling

In industry, computer modelling can be done using costly graphics programs. Ideas can be drawn in 3D and then rendered with colour, highlighting and shadow to make it look as realistic as possible. The drawing can then be rotated so that it can be viewed from any angle.

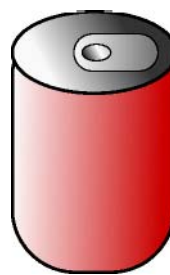

A computer rendered drawing of a drinks can

Computer programs can also model how a system works. For example, a car design engineer can draw a suspension system and then use the computer to animate it so that the parts can be seen moving together. The engineer can also put in what the forces are likely to be, to check that the parts of the system are strong enough for the job.

**A** At home, search for suitable model making materials, e.g. corrugated card from an old box, and then make a scale model of one of the products you find at home, e.g. washing machine, TV, video recorder, computer tower, table, wardrobe, etc.

**PRESENTING YOUR CHOSEN IDEA**

When the idea is fully developed and the materials, joints and finishes to be used have been chosen, the results must be presented. The presentation should be of high quality. There are two ways in which the presentation can be made.

1. A working drawing in orthographic projection.
2. A fully rendered pictorial (3D) drawing.

**Working Drawings**

A working drawing should include all the information required to make the product.

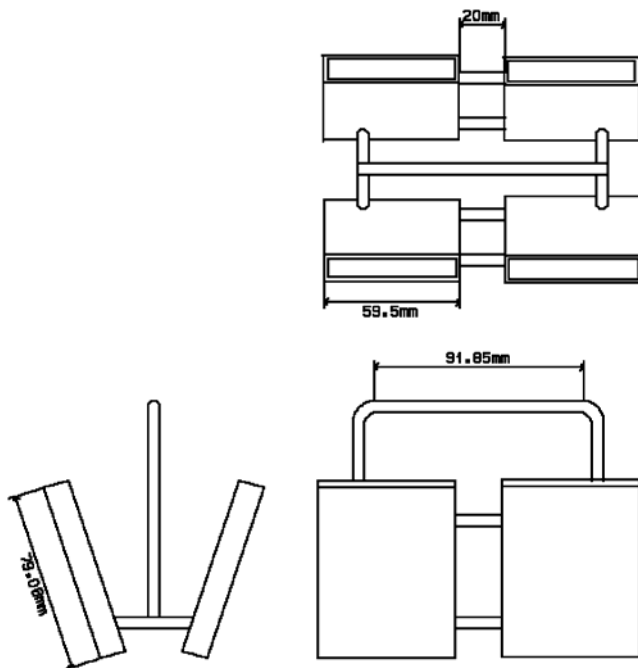

<b>Remote Controller Caddy</b>		<b>Box Material</b>	<b>Pine</b>
<b>Scale</b>	<b>1:4</b>	<b>Handle Material</b>	<b>Brass</b>
<b>Projection</b>	<b>3<sup>rd</sup> Angle</b>	<b>Handle Finish</b>	<b>Clear Lacquer</b>
		<b>Box Finish</b>	<b>Clear Varnish</b>
		<b>Box Joints</b>	<b>Rebate</b>
		<b>Handle Joints</b>	<b>Silver Solder</b>

The drawing above has a number of dimensions missing, this is to keep the drawing simple, so that it can be seen more clearly when reduced in size to fit this page.

A test of a good working drawing is that it should be possible for the manufacturer to make the product correctly without any contact with the designer. The drawing should give all the information required.

**Pictorial Drawing - In Isometric Projection**

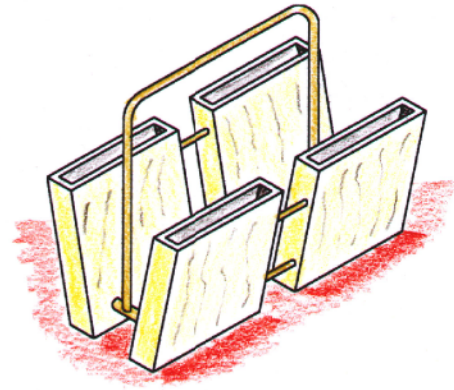

The pictorial drawing can be in Isometric or Oblique projection.

To get the best quality do the drawing with drawing instruments on a drawing board, or do the drawing on the computer in black and white, print it out and then hand render it.

The media can be coloured pencil, marker pen, poster paint or water colour, etc.

It is often improved by adding some background, the shading around the bottom half of the drawing above represents the back of the table that the product is sitting on.

**Commercial Presentation**

In industry, designers can present the final design, before making a prototype, in a number of ways, including a working drawing and rendered pictorial views. Other possible methods are:

- A fully detailed, realistic model
- A rendered 3D, CAD view
- An animated CAD 'video'

A fully rendered hand drawn presentation of a new car design.



Reproduced with kind permission of Simon Philpott

**A** Select a product at home or in the classroom and try to make the best quality pictorial drawing of it you can. Render it fully with highlights and shadows. Add some background to help the drawing stand out.

**WORKPLANS**

Before the designed product is to be made as a prototype it is a good idea to plan the order of how it is going to be made. This can be presented:

1. As information in table form
2. As a flowchart.

Below is a part finished workplan table.

The 'Quality Check' column is very important, because if the checks are not planned they will be forgotten and the product parts are unlikely to fit together well. The 'Notes' can be added with the teacher's advice.

The workplan should be photocopied and the copy taken into the workshop so that it can be looked at at the beginning of each session.

STAGE NO.	DESCRIPTION	QUALITY CHECK	NOTES
1	Plane pine for boxes	Check for any loose knots.	
2	Mark out pine for boxes		for accuracy use a marking knife
3	Cut the wood for boxes	Check the dimensions first	Use a sawing board on the bench
4	Mark out the rebate joints		Use a marking gauge
5	Plane the rebate joints	Check the plane set-up	Use a special rebate plane
6			
7			

**Workplan in flowchart form**

The flowchart is quick to follow but cannot support the addition of 'notes'.

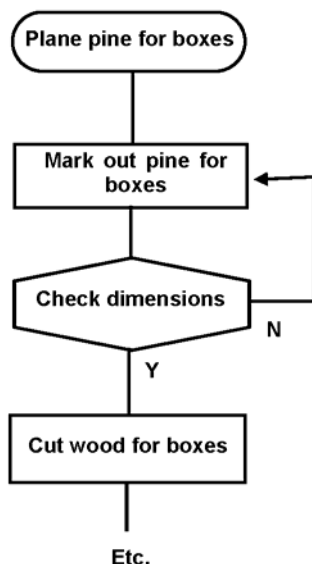

**Note:** One of the main reasons for completing a workplan is to make sure that things are done in the right order.

e.g. If the bracket shown was to be made from a strip of mild steel, it is important that the holes are drilled before the strip is bent, because it is very difficult to hold the strip for drilling after it has been bent into shape. When the strip is straight it can be easily held in a vice.

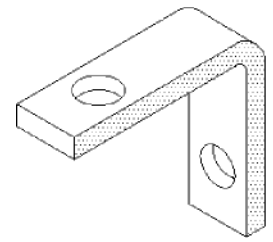

**DESIGN PROCESS CHECK LIST**

With the exception of Construction and Evaluation, which are done later, your folio should now contain the following sections:

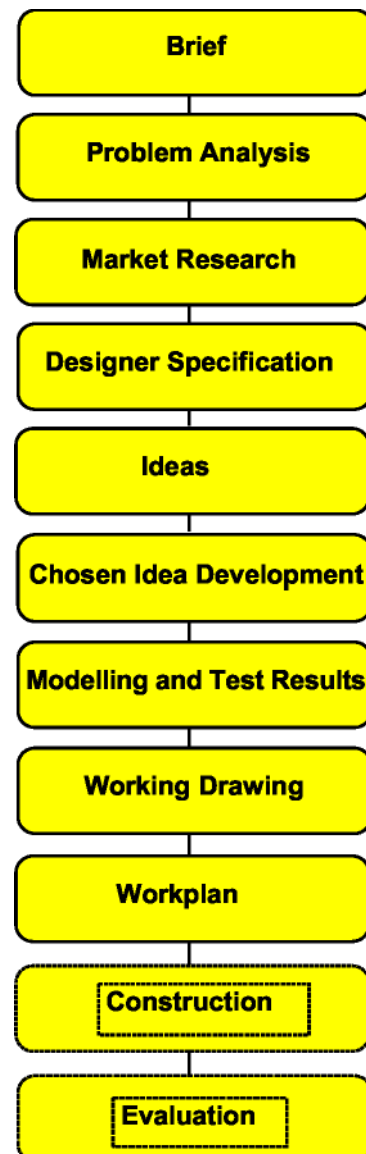



## EVALUATION

When the prototype has been finished it will need to be evaluated. There are a number of ways of doing this.

**Testing** The prototype needs to be tested against the Designer Specification, so that the following questions can be answered:

- Does it work as well as it should?
- Are there any improvements you would make if you had to continue developing the product?
- Is it comfortable and safe to use?
- Are the materials you chose a good choice?
- Is the prototype environmentally friendly?
- Can it be made within the budget?
- Did it take too long to make?
- Are the proportions balanced?
- Do the finishes and colour schemes work?
- What changes would have to be made if it were to be manufactured commercially?

### Further Questions can be asked:

- Was the original specification good enough?
- Were there any hidden costs?
- What are the product's strengths and weaknesses?
- Did you work efficiently and did it affect the project?

### Market Testing

To support your own thoughts about the product, it is a good idea to create a questionnaire and ask your family and friends to give their opinions by testing your prototype. Part of a typical questionnaire is shown below.

#### Remote Controller Caddy Evaluation Questionnaire

1. How would you rate the looks of the caddy?  
Poor  Acceptable  Good  Very Good
2. How easy do you find it to use?  
Difficult  Acceptable  Easy  Very Easy
3. Can all your controllers fit in the boxes?  
Yes/No
4. How easy do you find it to move around?  
Difficult  Acceptable  Easy  Very Easy
5. How much would you be prepared to pay for this design?  
£5 - £10  £11 - £15  £16 - £20
6. What changes would you suggest if it were to be developed further?

The finished evaluation should be a balanced assessment. You should not be too critical and do yourself down. Neither should you keep saying how brilliant you are and how everything you did was the best! By all means 'blow your own trumpet', when things have worked well, but balance this with some sensible criticism and recognise that nothing is perfect.



### Test your prototype

1. What is a Designer Specification?
2. List the **four** headings that you think are the most important in a specification.
3. When should the designer specification be used during the project?
4. When sketching ideas which **two** 3D drawing systems are most commonly used?
5. How can you make sure your sketch is of good proportion and not twisted?
6. When you are sketching ideas, how can you help another person follow your train of thought?
7. What are the **two** ways of developing your idea?
8. Where would you find information about material properties?
9. What tests do you need to perform on materials that you might use? (name at least **five**).
10. What is the difference between a model and a prototype?
11. Name **five** things that a model can be used for testing.
12. Name **five** model making materials.
13. Name **three** joining methods that are suitable for models.
14. Name **two** methods of presenting your final idea.
15. How can you tell that a working drawing is a good working drawing?
16. In what forms can you write a workplan?
17. Why are the quality check statements important?
18. Give an example of why you have to get the order of making right if you are to work successfully.
19. Which earlier document do you check when evaluating your prototype?
20. How can you extend your evaluation beyond your own thoughts about your prototype?
  - A As a consumer, evaluate **two** different mobile phones.
  - B As a consumer, evaluate **two** different school bags.

## WOOD PROCESSING

### Growth

Trees grow by the action of **photosynthesis** in their leaves. Photosynthesis is where the energy from sunlight is combined with minerals dissolved in water, drawn up from the roots, and carbon dioxide from the atmosphere, to provide food.

Each summer new growth is made from cells just beneath the bark. The cells produce new bark on the outside and new wood on the inside. One year's growth of wood is shown as a ring called an **annual ring**, which is often used to see how old a tree was when it was cut down. The rings are counted and the number of rings is the age of the tree in years.

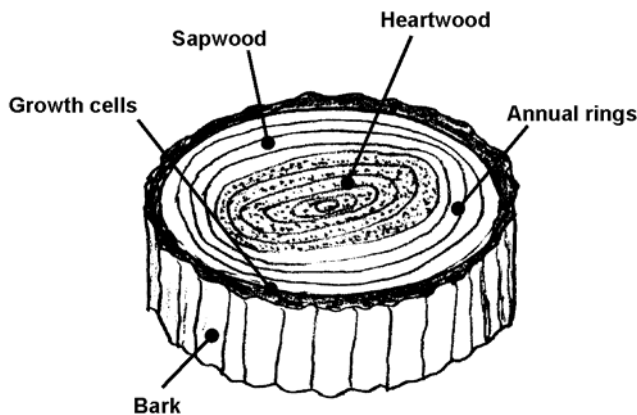

Older wood in the middle of the trunk dies and becomes harder, darker and drier and is called **Heartwood**, this is the best wood in the tree. The younger wood is still used for transporting food (sap) from the leaves to the rest of the tree and is lighter in colour and a lot wetter than heartwood and is called **Sapwood**. The **Bark** is used for protecting the tree.

### Conversion

To be useful, the wood has to be converted from a tree trunk to planks. This is done by sawing through the tree trunk. There are two common methods of sawing.

**Through and through** - a quick cheap method, but produces planks that are likely to warp.

**Quarter Sawn** - a more costly method that produces more waste, but the planks produced are less likely to warp.

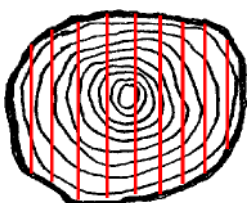

Through and through  
Conversion



Quarter sawn  
Conversion

### Seasoning

When the wood is cut into planks it is still very wet from the water taking the minerals from the roots to the leaves. If the planks dry quickly the wood splits and warps and becomes useless. To dry the wood slowly it is stacked in large drying ovens called **kilns**. The drying programme takes four or five weeks.

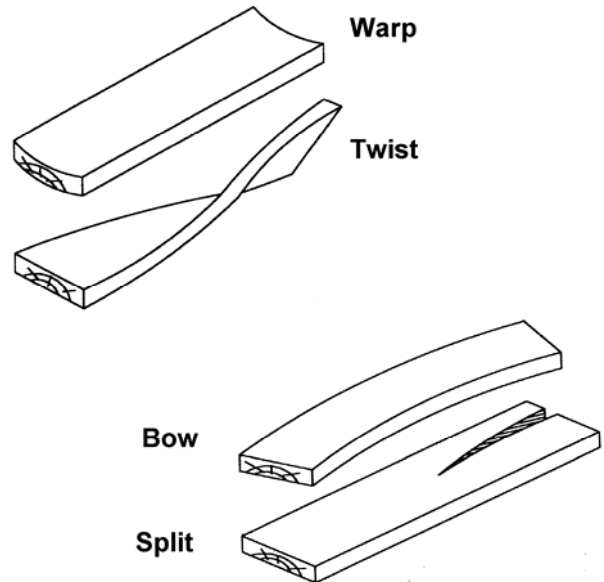

### Storage

When the wood is seasoned it should contain less than 10% water. Wood to be used for products that will be used indoors, needs to be stored indoors, so that it remains dry and keeps its low moisture content, and won't warp or split. It is best stored flat or vertically upright, so that it does not bend because of its own weight.

**KEY WORDS** Annual ring: Heartwood:  
Sapwood: Conversion:  
Seasoning: Warp: Bow

1. What is an annual ring?
2. How can the age of a tree be worked out?
3. Draw a sawn tree trunk and show the **five** main features that can be seen on the cut surface.
4. What are the features of Heartwood?
5. What does the term 'Conversion' mean?
6. Draw examples of **two** common methods of converting tree trunks. Explain their advantages and disadvantages.
7. What does the term 'seasoning' mean for seasoning wood?
8. Draw examples of what can happen if wood is seasoned too quickly.
9. How much water should be in the wood, if it is to be used indoors?
10. How should wood be stored, so that it stays flat?

**SELECTING WOOD**

**Types of Wood**

There are three types of wood, **Softwood**, **Hardwood** and **Manufactured Boards**.

**Softwood**

Coniferous trees (trees that keep their needle-like leaves throughout the year) provide softwood. They can grow quickly with straight trunks. They are often grown in plantations and are replaced when they are cut down. The wood is quite cheap and is used in the building industry for windows and doors etc. When the trunk is converted the waste is used for making paper and card.



**Hardwood**

Deciduous trees (trees that lose their large leaves every winter) provide hardwood. They grow slowly and sometimes have twisted trunks. They are often not replaced when cut down. The wood is costly and is used for fine furniture and wooden toys, etc.



**Note:** The difference between softwood and hardwood is a biological difference, not one of softness and hardness. The softest wood is Balsa - it is a hardwood!

**Manufactured Boards**

These are made from the waste wood left over from conversion. They use thin sheets (plywood), small blocks (blockboard), wood chips (chipboard) and wood fibres (fibreboard). They are generally cheaper than solid wood and can be made into large sheets that do not warp or twist easily.

**AVAILABILITY**

You can buy solid wood as rough sawn (very rough surface) or planed. The sizes shown at the wood yard are the rough sawn sizes (nominal size), if you buy the wood planed the true sizes will be up to 3mm less.

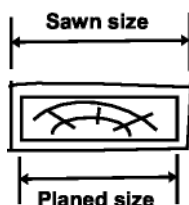

Planed planks can be planed top and bottom only, this is known as **PBS** (planed both sides). If the edges are planed as well it is known as **PAR** (planed all round).

**Shapes and Forms**

Wood yards sell wood in standard forms, the most common are shown below.

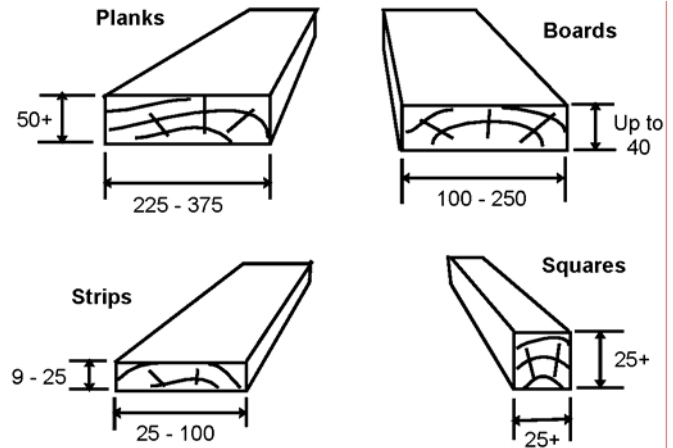

**Note:** The dimensions are in millimetres.

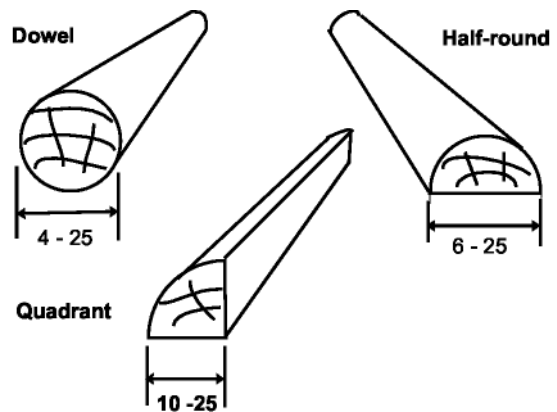

**Choosing Softwood**

NAME	PROPERTIES	USES	COST
Scots Pine (Deal)	Straight grained, but knotty, quite strong and easy to work	Building construction. When used outside it needs protection. Takes paint well.	Low
Parana Pine	Straight grained with few knots, quite strong and durable, warps easily	High quality interior construction and furniture	High
Spruce (white-wood)	Quite strong, with small knots, resistant to splitting but not durable	Fitted furniture, e.g. kitchen cabinets.	Low
Cedar	Straight grained that is knot free. Very light in weight. Very durable, inside and outside. Quite soft.	Used outside for shed construction and quality fencing.	High

**Choosing Hardwood**

NAME	PROPERTIES	USES	COST
Ash	Light in colour, flexible and tough, steam bends well, varnishes well.	Tool handles, cricket bat handles, ladders, veneers.	Med
Beech	Mid-brown colour, hard, strong and tough, tends to warp, steam bends well.	High quality furniture, toys, tool handles, veneers	Med
Oak	Light brown, hard, tough, heavy and durable outside. Gets harder with age.	High quality furniture, garden furniture, boat building, veneers	High
Mahogany	Red in colour, medium weight, quite strong, durable inside, warps easily	High quality furniture, shop furniture, boat fittings, veneers.	High

**Chipboard**

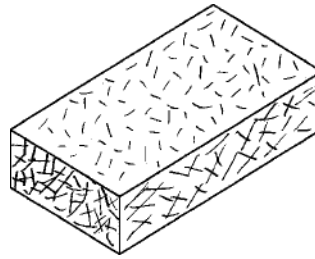

Made by compressing and gluing small chips of waste wood. When in use it is normally covered by a plastic coating or hardwood veneer.

**Hardboard**

Made by compressing and gluing pulped wood. It is smooth on one side and rough on the other.

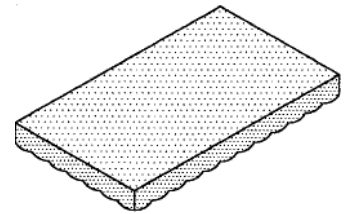

**Manufactured Boards**

**Plywood**

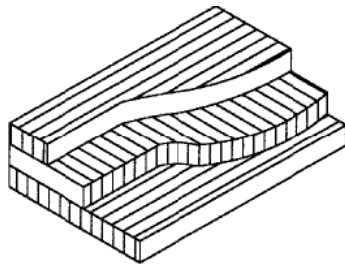

Made from thin sheets of wood (veneers), glued together with the grain direction at 90° to the one next to it. They always have an odd number of layers 3,5,7 etc. to reduce warping

**Medium Density Fibreboard (MDF)**

Made from fine wood fibres, compressed and glued together. When in use it is normally covered by a plastic coating or hardwood veneer.

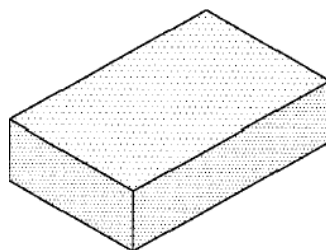

**Blockboard**

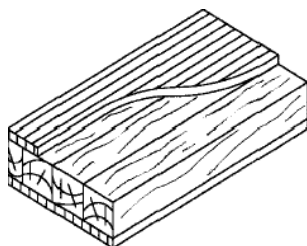

Strips of softwood are glued together and then sandwiched between two hardwood veneers. The edges look rough and are often covered with a thin hardwood strip

NAME	PROPERTIES	USES	COST
Plywood	Strong in all directions, quite stable but can warp. A water-proof ply is available.	Tabletops, worktops door fronts, drawer bottoms, small boats (waterproof ply)	Med
MDF	Does not warp easily, cuts and planes well without splitting, needs a finish.	Tabletops, worktops, veneered furniture, clock cases.	Med
Blockboard	Does not warp easily. Very strong, rigid and rather heavy. Edge finishing is difficult.	High quality furniture, stage flooring, fire doors.	High
Chipboard	Heavy, can warp easily, joining pieces together is not easy, needs a finish.	Cheap plastic coated furniture, roofing boards, partitions	Low
Hardboard	Not very strong, warps easily, needs a finish.	Door panels, cheap drawer bottoms, cabinet backs.	Low

1. What sort of trees do hardwoods and softwoods come from
  2. What are manufactured boards made from?
  3. What do the terms 'PAR' and 'PBS' stand for?
  4. If you purchased wood that was advertised as 50mm wide and 25mm thick, but was PAR, what size would you expect the wood to be?
  5. What is the difference between a plank and a strip of wood?
  6. Which softwood might you choose to make a dog kennel from?
  7. Which hardwood might you choose to make a child's toy truck?
  8. Explain how plywood is constructed.
  9. Which manufactured board might you choose to make a long shelf for heavy books?
  10. What is the environmental advantage of making and using chipboard?
- A** List **five** different uses for wood and manufactured board that you can find at home, and state which type of wood or board you think are used.



## PREPARING WOOD FOR USE

## Checking

When solid wood is taken from the store, it needs to be checked before it is used. The following checks are recommended.

1. Look along the length of the strip of wood and see if it is warped, bowed or twisted.
2. Check the ends to see if there are any splits.
3. Check for knot holes or loose knots.
4. Check to see if there are too many knots, because they may make the wood hard to plane smooth.
5. Check for small holes made by insects such as woodworm.

If the wood you look at has any of the above problems it is best to reject it and carry on searching.

## Cutting what you need

Rather than cut from the strip all the individual pieces of wood you want, it is better to add up the length of all the bits of wood you need and add the lengths together to get a total length. (Add 3mm to each length to allow for sawing waste).

Mark a line across the strip with a try-square and pencil and then saw off the wood you need. For example, below is a design for a simple box to be made from 9mm thick Parana Pine.

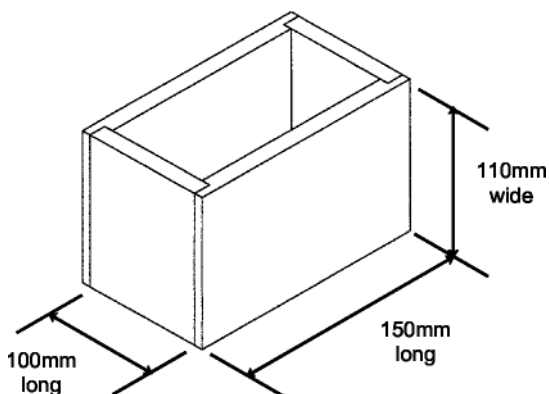

What is needed is:

- 2 sides - each 150mm long and 110mm wide.
- 2 ends - each 100mm long and 110mm wide.

Therefore the total length of wood required is:

$$2 \times 150 = 300 \text{ plus } 2 \times 100 = 200, \text{ total} = 500\text{mm}$$

Add 3mm for the sawing waste of each piece  
(4 pieces) = 12mm

The final length of wood to be cut off the strip is 512mm.

If the strip is wider than the wood you want then you will have to mark out the correct width with a marking gauge and then saw and plane it to size.

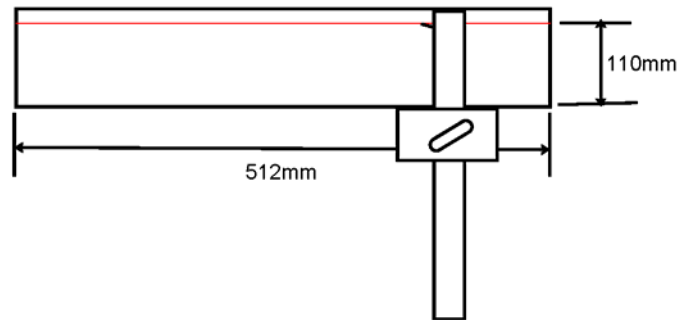

When you have nearly finished planing it, check that the edge is at right angles to the sides by using a try-square.

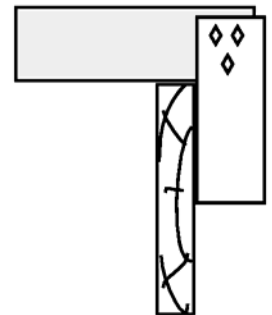

The sides and ends are now ready to be marked out. **Remember** to leave a 3mm gap between each piece to allow for sawing waste.

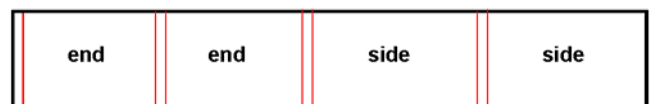

When the pieces have been sawn off, the ends will need to be planed or sanded to the line.

The wood is now ready for use.

1. Name **five** things that need to be checked before a length of wood is selected for use.
2. How much do you have to add to a length to allow for sawing waste?
3. What would be the total length of wood required for a box that has sides 325mm long and ends 250mm long?
4. Which tool would you use to mark the width of wood required?
5. What would you check when planing the wood to width and which tool would you use?

**MARKING OUT WOOD**

**Positioning**

When you wish to cut a shape from a manufactured board, you should mark it out in one corner in order to create as little waste as possible.

e.g. A circular base for a table lamp is required.

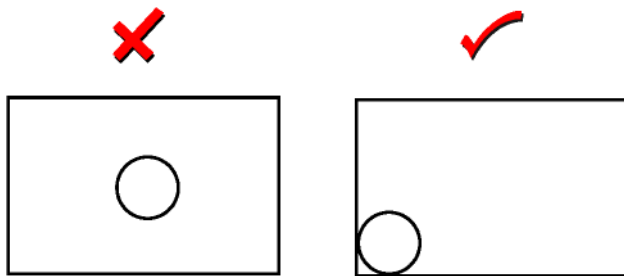

Incorrect marking out, it is difficult to cut out and a lot of the board will be wasted.

Correct marking out, it is easy to cut out and wastes very little.

**Using the Face-side and Face-edge**

When you are ready to mark out joints on a strip of wood you need to look carefully at each of the sides and edges and select the best side (flat and smooth with no damage) and the best edge. These will now be known as the **Face-side** and the **Face-edge** and should be at right angles to each other. So that you can remember them you will need to pencil mark them with traditional symbols.

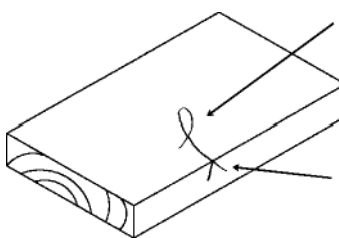

The loop is the face-side symbol. The tail should go to the corner of the face-side.

The upside-down 'v' is the face-edge symbol. The point should touch the end of the tail of the loop.

When you measure across the wood you should always start the measurement from a face-side or face-edge. Also when you use a try-square to draw lines across the wood you should hold the square so that the handle is always touching a face-side or face-edge.

The handle of the try-square is touching the face-edge

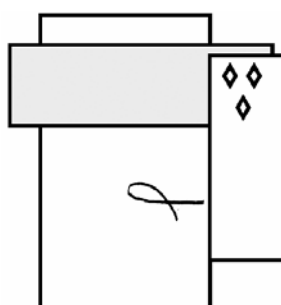

If you need to draw a line along the piece of wood, the most accurate way is to use a **marking gauge**. The gauge should run along a face-edge. This will produce a scratched line which may need a pencil point run along it to make it easy to see. A scratched line cannot be rubbed out accidentally.

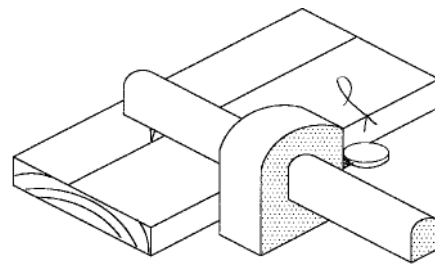

To mark out circles and arcs use a pair of **dividers**, (they have a sharp point on both legs).

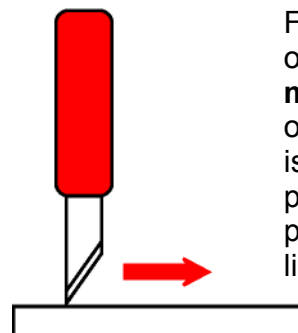
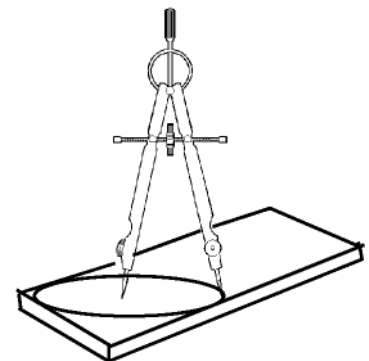

For accurate marking out you need to use a **marking knife** instead of a pencil. The blade is a lot thinner than a pencil lead and it produces a scratched line.

**KEY WORDS Face-side: Face-edge: Marking gauge: Dividers: Marking knife**

1. How can you reduce the amount of waste when cutting a shape from a large board?
2. How can you identify the face-side and face-edge of a piece of wood?
3. Draw the symbols for the face-side and face-edge.
4. For accurate marking out of lines across a piece of wood show how the try-square should be placed.
5. What tool would you use to mark a line parallel to an edge?
6. Why is a scratched line more useful than a pencil line?
7. How can you tell the difference between a pair of dividers and a pair of compasses?
8. Which tool can you use to scratch an accurate straight line?

## SHAPING WOOD – WASTING

**Wasting** is the term given to any of the cutting processes that produce waste material.

**Sawing** Hand-held saw blades are made from Tool Steel alloyed with Vanadium and Molybdenum, to give toughness and long lasting sharpness.

The saw cutting action - each tooth cuts a little deeper as the saw moves forward.

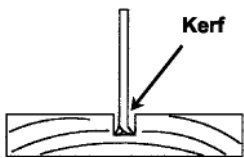
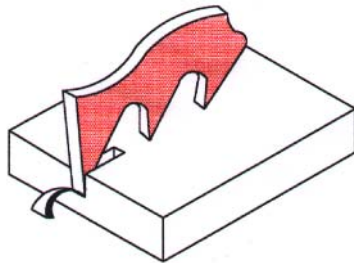

Each tooth of the saw is alternately bent to the right and the left of centre. This is to stop the blade from jamming in the cut. The width of the cut is called the **kerf**.

Wood must be well supported when being sawn.

When sawing small pieces of wood use a **bench hook** (also known as a sawing board). The bench hook should be held in the bench vice to stop it moving and the wood is held in place by hand.

Use the end of the stop to guide the saw

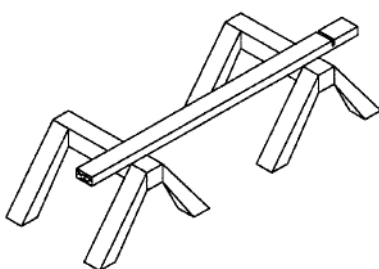
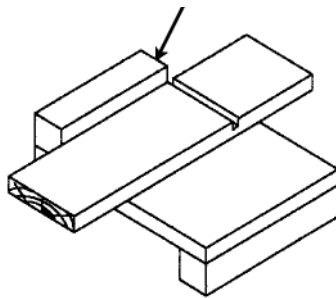

When sawing long pieces of wood, use a pair of **trestles** (also known as sawing horses). The wood can be held by G-clamps.

**Panel Saw**

A large saw used for making straight cuts. Saws with large teeth are for cutting along the grain (**Rip Saw**). Saws with smaller teeth are for cutting across the grain (**Cross-cut Saw**).

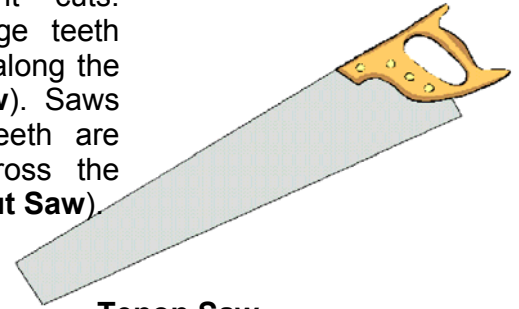
**Tenon Saw**

A medium length saw that has a brass or steel back to keep the blade rigid. It is used for making straight cuts and especially designed for joint cutting. A smaller version is known as a **Dove-tail Saw**.

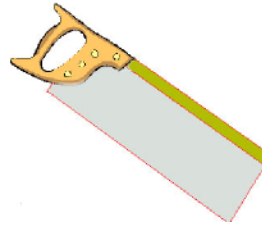
**Coping Saw**

A thin bladed saw used for making curved cuts. The blade can be set at any angle so that long cuts can be made without the frame getting in the way.

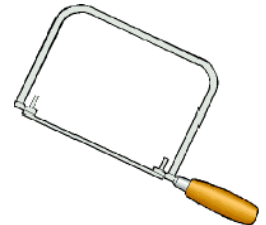
**Purchasing Saws**

Saws can be bought with different size teeth. The size of teeth is measured by the number of teeth there are in a one inch length along the blade. This is known as 'Teeth per Inch' or 'TPI'. The more teeth per inch, the smaller the teeth.

**KEY WORDS Kerf: Bench hook: Trestle:**

1. Explain the term 'kerf' using notes and a diagram.
2. How would you support a small piece of wood while you are cutting across it? (answer with a diagram).
3. Show how you would support a long length of wood for sawing.
4. Which saw would you choose to cut a finger joint and why?
5. Which saw would you choose to cut a large sheet of thick plywood in half and why?
6. You need to cut the shape of a number '2' from a small sheet of thin MDF, which saw would you use?
7. What is the meaning of the term 'TPI'?
8. You are cutting a curve along a thin strip of pine, the frame of the saw gets in the way, how can you complete the saw cut?

**SHAPING WOOD – PLANING**

Planes are used for removing waste wood and smoothing the surface before applying a finish. A correctly planed surface is smoother than can be obtained by using glasspaper. There are many different planes designed to cope with different situations. The most common planes are the 'Jack Plane' and 'Smoothing Plane'. They look alike but the smoothing plane is smaller.

If the blade is not parallel to the base and one corner is further out than the other is, it can be adjusted by moving the level adjustment lever to correct it.

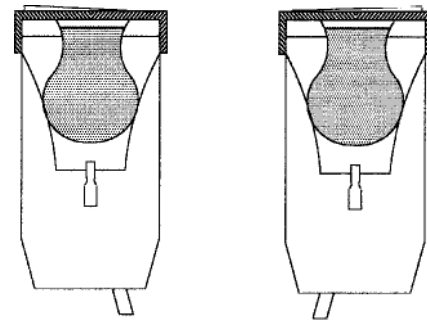

Direction of movement to make the blade level

**The Jack Plane and Smoothing Plane**

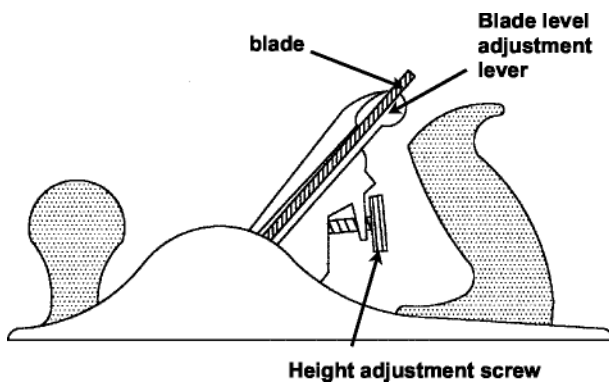

If the blade is not showing or it is out too far then the **height adjustment screw** needs to be turned. It is turned clockwise to make the blade move out and anticlockwise to make the blade move in.

**Note:** When the direction of turn is changed there is quite a lot of slack to make up before the blade moves.

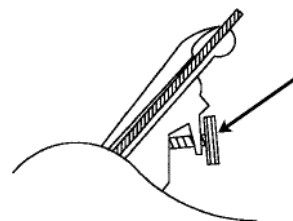

Height adjustment screw

**Checking and adjusting the plane**

The plane should be checked each time that it is taken from the store. The blade cutting edge should be parallel to the base of the plane and be showing no more than 0.5mm. Shavings should be tissue thin for a smooth finish.

If the wood is not planed in the correct direction the surface will end up very rough. To check the direction, the **side** of the piece of wood should be looked at, not the top surface being planed. Look at the direction the grain is approaching the top surface and then plane in the same direction.

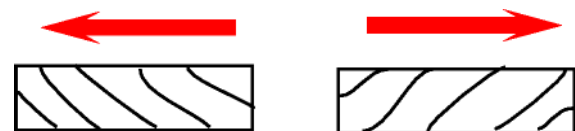
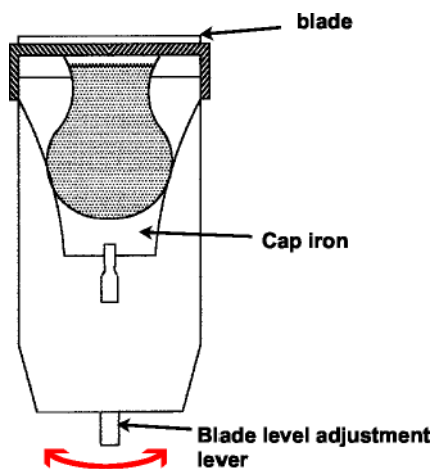

If the grain is parallel to the edge then it is possible to plane in either direction and gain a smooth finish.





### Planing procedure

At the start of the stroke the front should be held down firmly on the end of the piece of wood with the blade clear of the wood. The other hand should be used to push the plane along the surface. When the blade has passed over the other end of the piece of wood the plane should be lifted clear and returned to its starting position. If the plane is not lifted clear the results of the planing cannot be seen for checking.

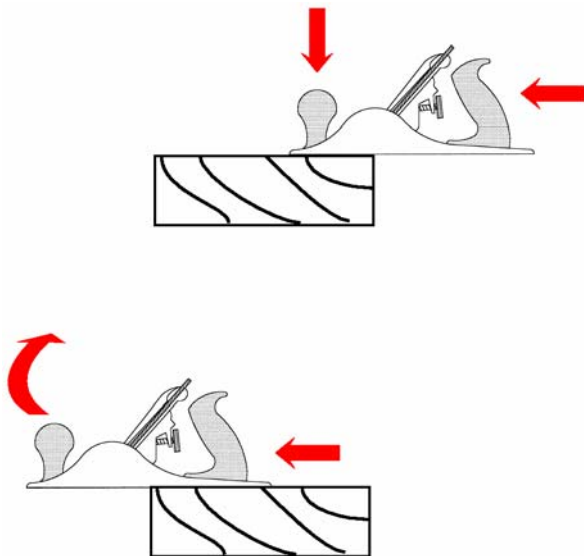

### Planing end-grain

If the plane is taken over the end of an end-grain surface the wood will split. To stop this, always lift the plane early just beyond the centre and then plane in the other direction and lift early.

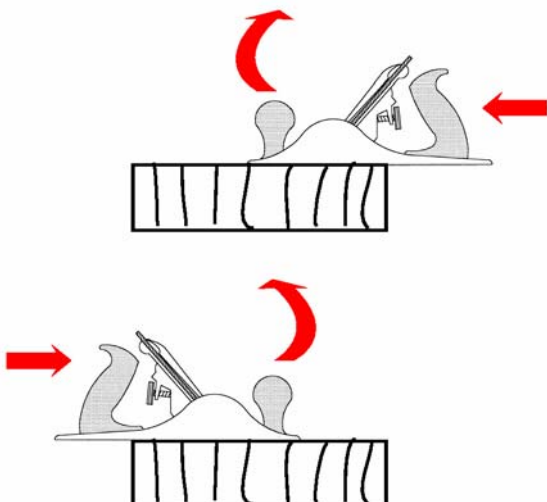

Another method, suitable for narrow pieces, is to clamp a piece of waste wood with an angled (chamfered) corner to the side and plane the full width. The waste wood will hold the grain of the work together and stop it splitting. The chamfered corner of the waste wood is resistant to splitting (a). A third method is to chamfer one or both corners of the wood to be planed (b).

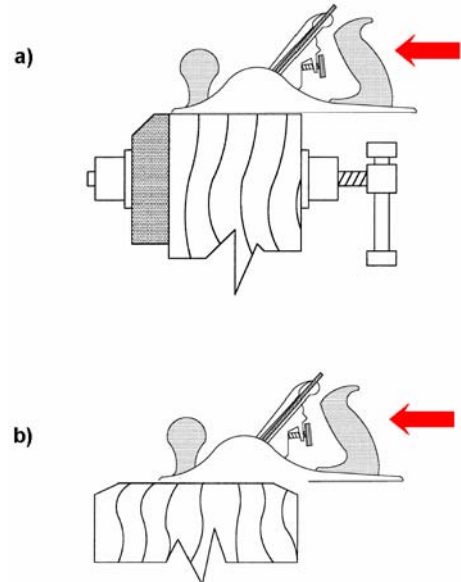

**KEY WORDS** Jack plane: Smoothing plane: Shavings

1. Name the two most common planes to be found in a workshop.
  2. Why does a plane need to be checked when it taken from store to be used?
  3. Which adjusting device would you use if the blade was out too far?
  4. Which adjusting device would you use if the blade was not parallel to the base?
  5. What is the recommended maximum amount of the blade that should be showing?
  6. How can you tell which direction to plane a piece of wood to get a smooth finish?
  7. If the grain is mainly parallel to the edges, in which direction can you plane it?
  8. What happens if you try to plane end-grain in the same way as side-grain?
  9. How can you overcome the problems involved in planing end-grain on a wide board?
  10. What is the recommended method of planing the end-grain of a narrow piece of wood?
- A** Using an A4 sheet of paper in either portrait or landscape mode, design and produce a wall poster that shows how to plane a real wood surface so that the result is smooth.

**SHAPING WOOD – CHISELLING**

Chisels are used for **chopping** away waste wood when cutting a joint and for **paring** small amounts of wood away when fitting the two halves of the joint together accurately.

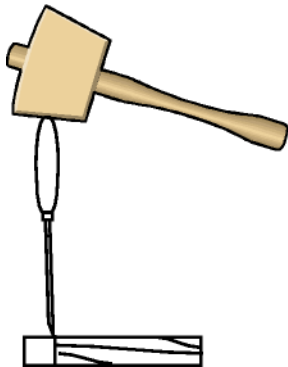

Chopping, using a mallet

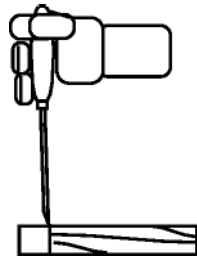

Paring by hand

**Firmer chisel**

The firmer chisel, like most chisels, has a blade made from tool steel and a handle made from Ash or polycarbonate and is designed for chopping away waste wood. The ferrule is a brass ring that stops a wooden handle from splitting.

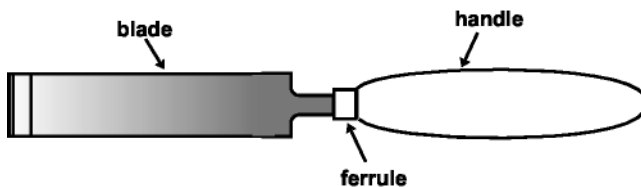

**Bevel-edged chisel**

The blade is thinner at the edges than a firmer chisel and is used for paring and for cleaning out corners.



**Safety Note:** when paring always keep both hands behind the blade of the chisel to avoid cutting yourself.

An end-on view of a firmer chisel in use

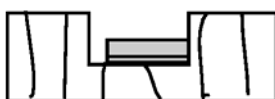

An end-on view of a bevel-edged chisel in use

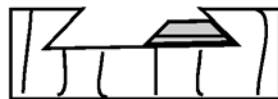

**Mortise chisel**

The mortise chisel is used for cutting the hole (the mortise) for a mortise and tenon joint. It is designed to withstand being hit hard with a mallet. The leather washer helps to absorb some of the shock and the steel ferrule stops the handle from splitting at the end.

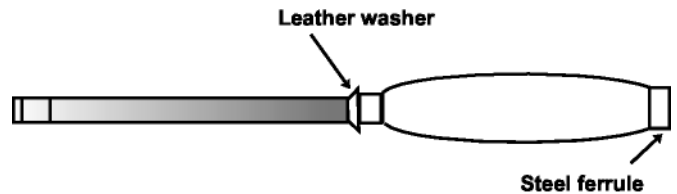

**Gouge**

The gouge has a curved blade and is used to cut shallow depressions in wood.



An end-on view of a gouge in use



**KEY WORDS** Firmer: Mortise: Bevel: Gouge: Paring

1. Make a labelled sketch of a firmer chisel.
  2. From what materials are chisel handles made?
  3. What is the purpose of a ferrule on the handle of a chisel?
  4. What is the advantage of the bevelled edges on a chisel?
  5. State a safety rule that you should observe when using a chisel.
  6. From what material are chisel blades made?
  7. What is a mortise chisel used for?
  8. What is the purpose of the leather washer found on a mortise chisel?
  9. What is the difference between a gouge and a firmer chisel?
  10. What is a gouge used for?
- A** Create an A4 size poster in your own style showing the uses for the firmer, bevel-edged and mortise chisels plus the gouge.

**SHAPING WOOD – DRILLING**

A hole is cut by **drill bit**, the tool that holds the bit is known as the **drill**.

**Drilling by hand**

**Hand drill**

This tool is designed to hold straight shanked jobber bits up to 10mm diameter. It can also hold countersink bits

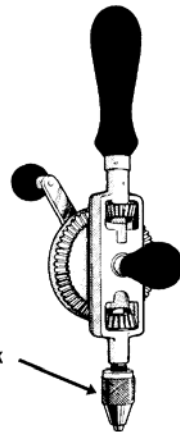

The shank  
(the part held in the tool's chuck)

**Jobber bit**

The bit is made from High Speed Steel (HSS). Diameter with a straight shank is from 1mm to 13mm.



**Countersink bit**

The bit is made from HSS. It is used to widen a previously drilled hole, so that a countersunk screw head can be screwed level with the wood surface.

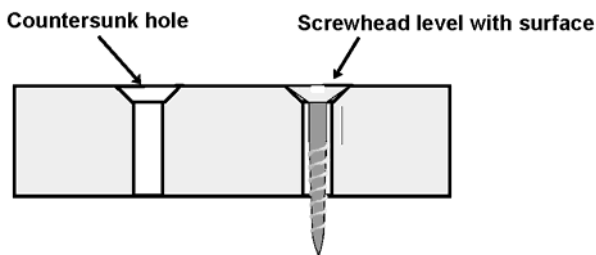

**Note:** If a hole is to be drilled all the way through a piece of wood, then the wood needs to be supported so that it does not split when the drill bit breaks through the other side. **Do not** drill through to the metal drill table or the bench top.

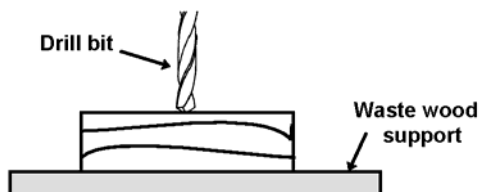

**Power tool drilling**

**Pillar drill**

This drill is so named because the main parts can be made to slide up and down the central pillar. It is suitable for all the bits shown on this page.

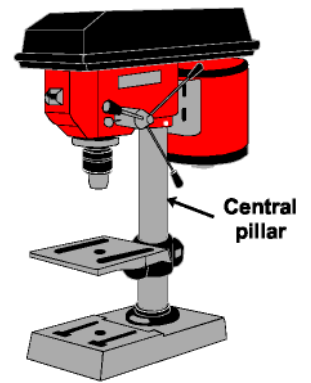

**Flatbit**

This bit is only suitable for use in power tools. It is useful for larger holes from 8mm to 25mm diameter. It is made from HSS.

**Hole saw**

This is only suitable for use in power tools. It cuts very large holes from 20mm to 80mm diameter. The saw and guide bit are made from HSS.

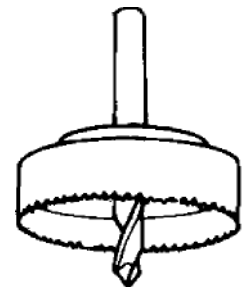

**Note:** When using a flatbit or hole saw, only cut the hole until the point of the flatbit, or the guide bit of the hole saw, break through the other side. Then turn the wood over and using the break-through hole as a guide, cut the second half of the hole. This method will stop the wood from splitting.

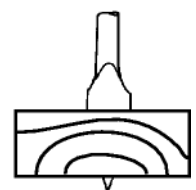

1. What is the chuck on a drill used for?
2. What are good quality drill bits made from?
3. Draw a diagram showing a countersunk hole and what it is used for.
4. How do you prevent wood from splitting when a hole is drilled all the way through it with a jobber bit? Use a diagram in your answer.
5. Why is a pillar drill so called?
6. When would you use a flatbit instead of a jobber bit?
7. When using a hole saw, how would you prevent the wood from splitting?
8. Which bit would you choose to use if you had to drill a 35mm hole and why?

## USING POWER TOOLS

It is very important that power tools are used safely. When used correctly, they can produce accurate work in a very short time. If they are used incorrectly they can ruin work in a very short time and possibly injure the user.

### Rule 1.

**Never use a power tool until you have received instruction on how to use it safely!** What you will read on this page is **not** a substitute for live instruction, given by your teacher. This page is meant to help you remember the rules, not learn them.

**Disc Sander** A very useful machine for sanding down the end grain of wood and the edges of sheet plastic.

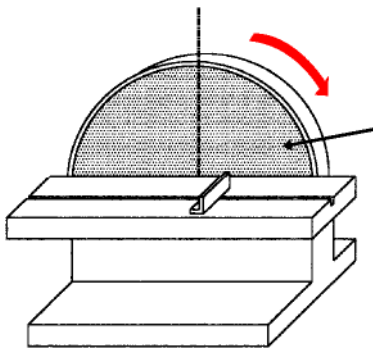

Only use the right hand quarter of the disc, where it is moving down towards the table. This is to stop your work from being thrown off the machine.

Never sand small pieces of wood. If your finger touches the revolving disc you will receive a very painful graze. A good rule is that when the wood is touching the disc it should be covering the slot in the table. If it doesn't, it is too short.

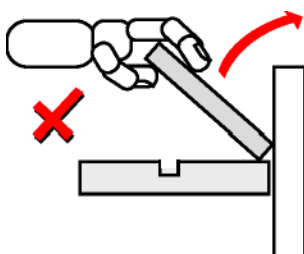
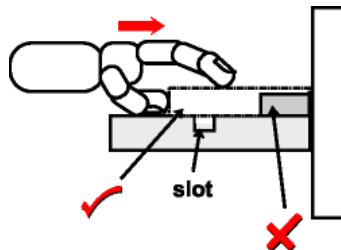

Do not be tempted to use the disc for sanding corners. The wood is likely to be forced in the direction of the arrow and could be thrown off the machine.

To spread the wear of the disc and to help avoid burning the wood, keep moving the wood from side to side in the right hand quarter of the disc. This action stops the disc from clogging.

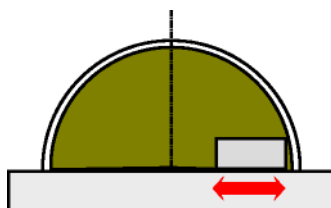

## Scroll Saw

This machine is also known as a **Fretsaw**. It is used for cutting thin sheets of wood, manufactured board and plastic. It is best used for curved cuts rather than straight cuts.

The saw is reasonably safe because the blade moves up and down through a short distance. If a finger touches the blade lightly, the flesh tends to move up and down with the blade and is not cut by it. However, a finger jammed against the blade will be cut by it.

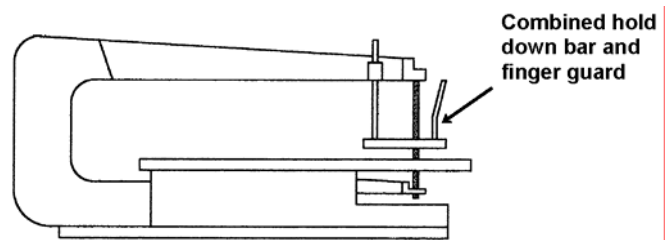

Position the hold down bar no more than 0.5mm above the material being cut. This will stop the material from jumping up and down with the movement of the blade.

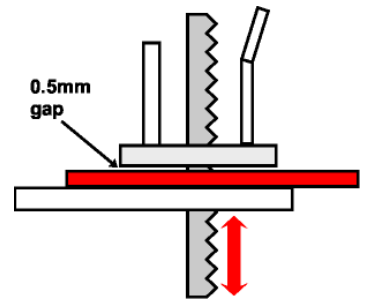

## Portable Tools

Mains operated power tools can be dangerous if the power lead is allowed to trail over the workshop floor. Power leads are often tripped over by other workshop users. It is important that you use the tools as close to the electric socket as possible.

### Orbital sander

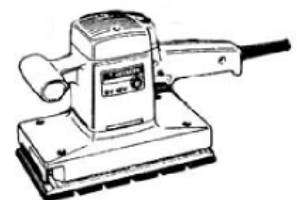

**Note:** Power tools do not stop instantly, always let them run down and stop before putting them aside.

1. What is the most important rule concerning the use of power tools?
  2. Why is it dangerous to try and sand small items on a disc sander?
  3. How can you tell if a piece of wood to be sanded is too small for safe use of the machine?
  4. Why should the wood being sanded be moved from side to side?
  5. Why is it unlikely that you would cut your finger when using a scroll saw?
  6. When using a scroll saw, how can you stop the material being cut moving up and down with the blade?
  7. What is the main precaution you need to take when using a mains operated, portable drill?
- A. Create a safety poster to help promote the safe use of a sanding disc or scroll saw.



**FABRICATION - WOOD JOINTS**

The word **fabricate** means to join together.

Most wooden products are held together with adhesive. Adhesive works very well when the edge of a piece of wood is being glued to the edge of another piece of wood (side-grain to side-grain). A solid wood table top is made this way.

**Rubbed joint**

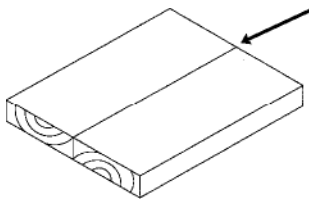

Adhesive is put between the two edges. They are then rubbed together to spread the adhesive evenly. The boards are lined up and held together with sash cramps

If, however, you are making a framework or box and need to join end-grain to side-grain, adhesive on its own will be too weak. By cutting joints, side-grain surfaces on one piece of wood can be made to come in contact with side-grain surfaces on the other piece of wood. The side-grain to side-grain contact means that the adhesive will now be stronger.

**Butt joint**

This is a very weak joint unless it is strengthened with pins or screws

End-grain to side-grain contact

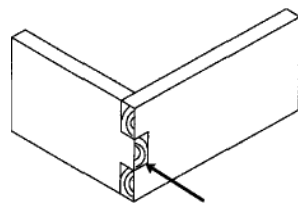
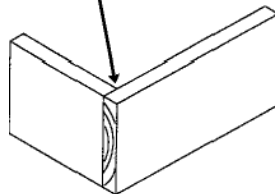

**Comb or Finger joint**

Side-grain to side-grain contact for extra strength

The joint is also mechanically stronger. Any force in the direction of the arrow will not push the joint apart even if there is no adhesive holding it together.

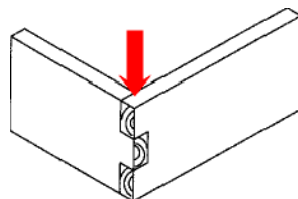

**Framework joints**

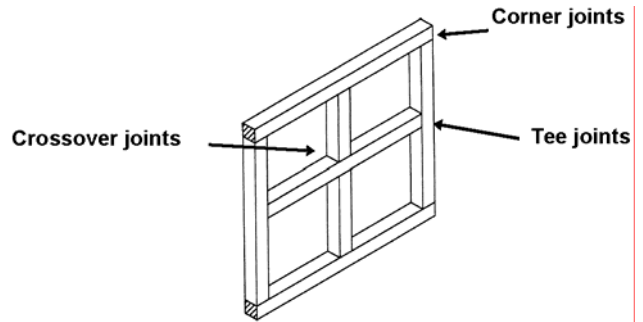

**Corner joints**

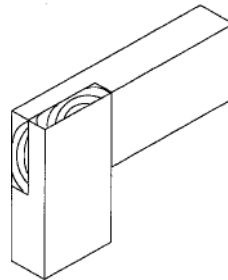

**Corner Halving**

Used for lightweight frames and frames that are to be covered by boarding e.g. a door. The joint is quick and easy to cut

**Corner Bridle**

Used for heavier, stronger frames because it has a large area of contact and cannot be twisted apart unlike the halving joint. The joint is quite difficult to cut

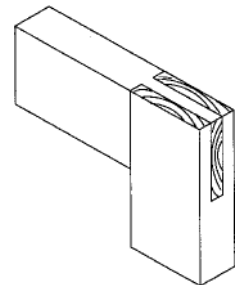

**Dowel**

Used for lightweight frames. The holes are difficult to line up unless a doweling jig is used.

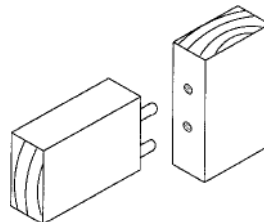

**Tee joints**

**Tee Halving**

Used for lightweight frames, especially those to be covered with boarding. The joint is quick and easy to cut.

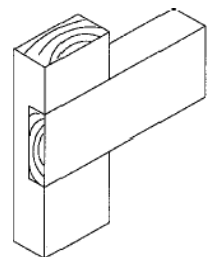

**Box joints**

Used for general furniture construction.

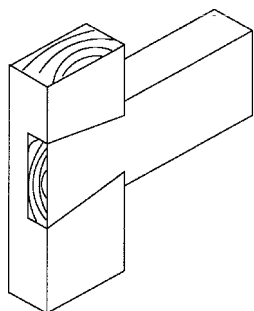

**Dovetail Halving**

A stronger version of the Tee Halving. Used for medium weight frameworks.

**Mortise and Tenon**

A strong joint that is quite difficult to cut and fit by hand. Used for heavier frameworks and uncovered frameworks.

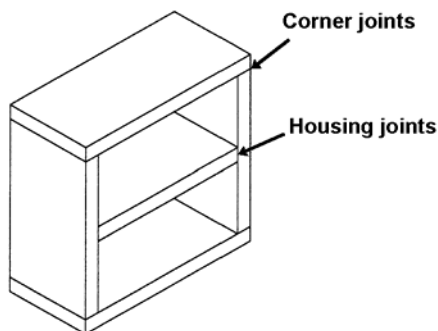
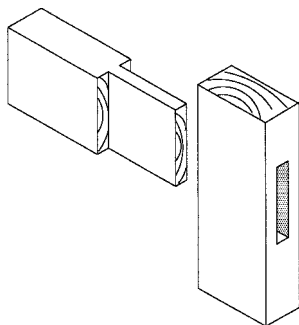

**Butt joint**

A weak joint on its own. The example shown has a reinforcing wooden strip glued to the inside. A quick and easy joint to make. This joint can also be used with manufactured board.

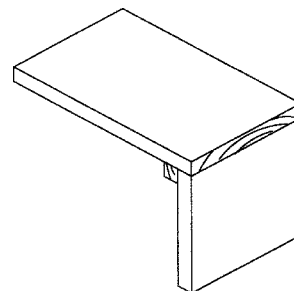

**Crossover joints**

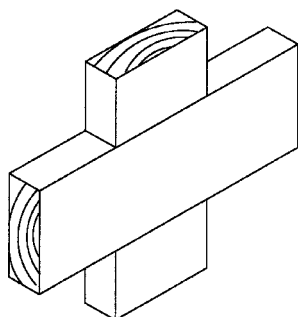

In some frameworks pieces of wood have to cross one another

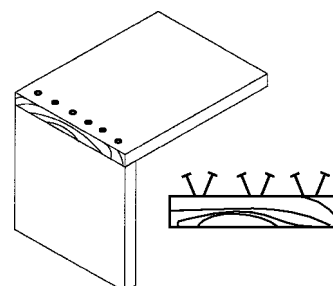

Another way of reinforcing the joint is to use pins. For greatest strength the pins are best used in pairs and angled towards each other. This is known as dovetail pinning.

**Cross Halving**

This joint is quite strong and resists twisting. This is the only crossover joint that is flush (flat) on both sides.

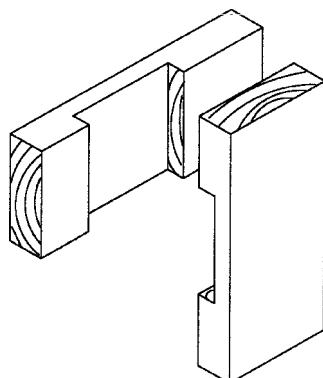

**Lap joint**

Although stronger than a butt joint, the lap joint is best when reinforced with dovetail pinning or screws.

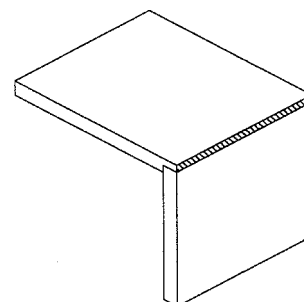

**Mitre joint**

This joint although weak, has the advantage of not showing any end grain, it looks neat and clean.

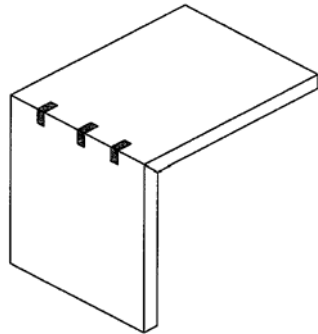
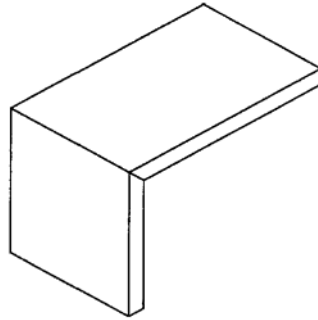

To reinforce the joint, grooves can be cut into the corner and then triangular pieces of thin wood are glued into the grooves.

**Dowel joint**

This looks like a butt joint but is a lot stronger. It is difficult to line up the holes without using a dowelling jig. This joint can also be used with manufactured board.

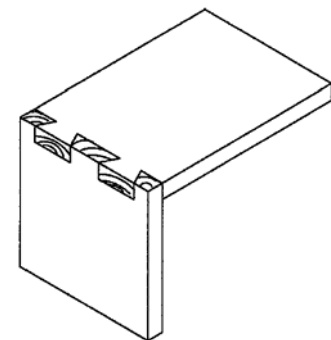
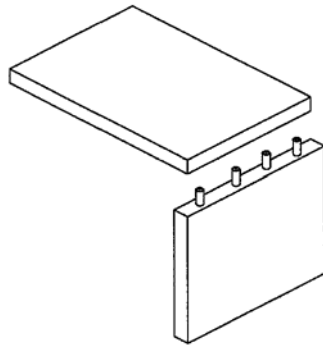

**Dovetail joint**

A very strong joint. Used for drawers where the front is pulled every time the drawer is used. It is difficult to mark out and cut. This joint is also used as a design feature.

**Comb or Finger joint**

A strong joint (a lot of side-grain to side-grain contact). The joint can be considered as a design feature because if it is well fitted it adds to the good looks of the furniture.

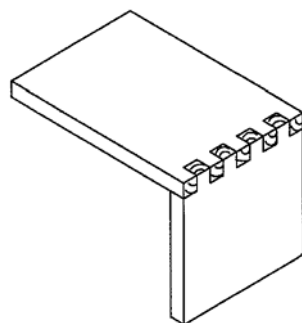

**Housing joints**

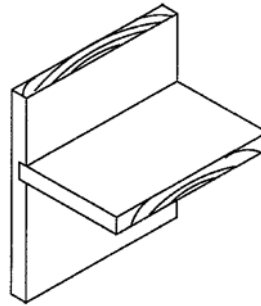

**Through Housing**

Used for fitting shelves into cabinets or units and partitions in boxes.

**Dovetail Housing**

A stronger form of a through housing. The groove is best cut with an electric router.

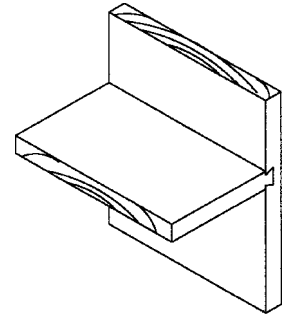

**Stopped Housing**

Can be either a plain or dovetail housing. It has the advantage of not showing the joint at the front

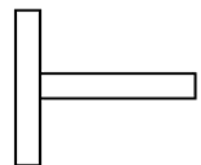
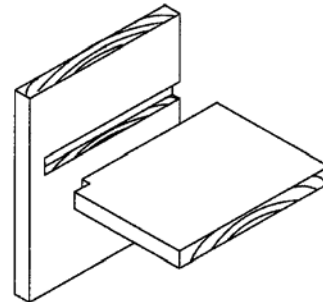

1. In what way should wood be glued together to get maximum strength?
  2. In what ways is a cut joint stronger than a butt joint?
  3. Name and sketch **two** joints suitable for the corner of a framework.
  4. Name and sketch **two** joints suitable for tee sections of a framework.
  5. Show how a weak butt joint can be reinforced.
  6. Show how a mitre joint can be reinforced.
  7. What is the main problem to overcome when making a dowel joint?
  8. Name and sketch a joint that is suitable for joining a drawer front to its sides.
  9. How can you join two lengths of wood that cross over each other?
  10. Name and sketch a joint suitable for holding a shelf in place.
- A** Select a piece of furniture at home or in the classroom, sketch it and then draw the joints that you think have been used for the fabrication.

**CUTTING A COMB JOINT**

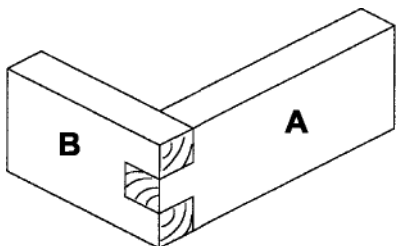

1. Using a try-square and marking knife or pencil, mark out the shoulder line all the way round one end of A and B.

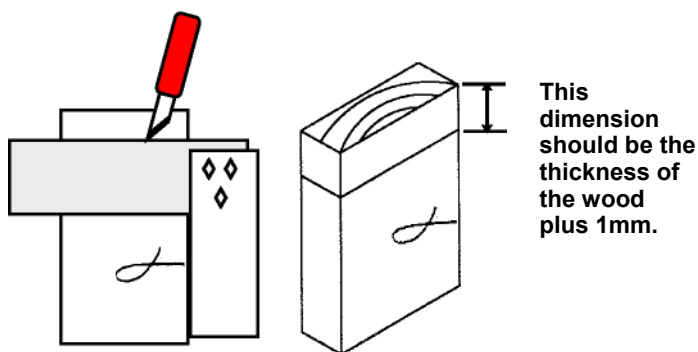

2. Using a marking gauge, mark out the comb 'teeth'. Set the gauge gap to 1/3rd the width of the wood. Check that both pieces match.

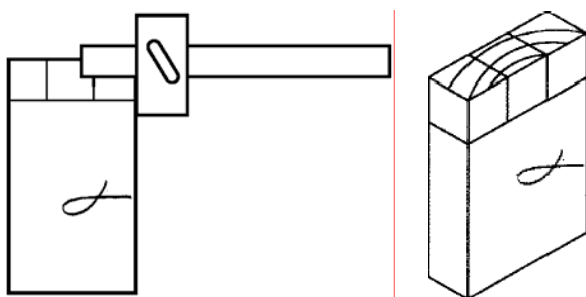

3. Put squiggle marks with a pencil upon the parts to be cut out (the waste).

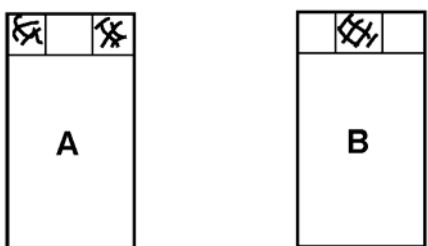

4. Using a tenon saw, cut down on the waste side of each 'tooth'.

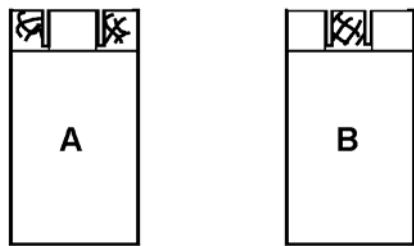

5. On part A use a tenon saw to cut on the waste side of the shoulder line.



6. On part B use a tenon saw to cut diagonally across the recess.

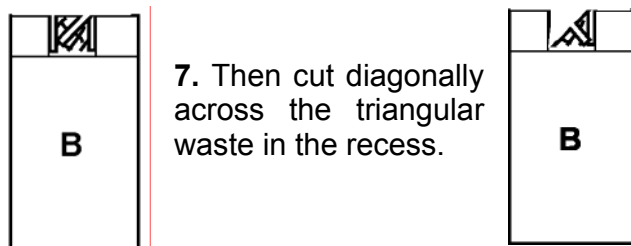

7. Then cut diagonally across the triangular waste in the recess.

8. Use a mallet and chisel to chop the remaining waste down to the shoulder line.

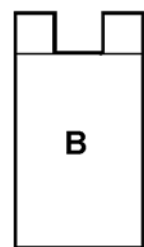

9. Using a bevel-edged chisel pare down all the cut surfaces to the lines. Then try to fit the joint together, **do not force the parts together**. If they won't fit, check carefully to see which parts are too large and pare a small amount off them, then test again. Keep paring and testing until the joint fits perfectly.

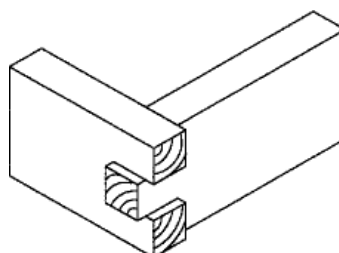

The overlapping parts can be planed flush once the joint has been glued together.



**CUTTING A MORTISE & TENON JOINT**

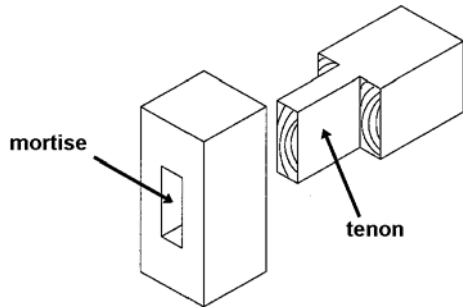

1. Using a try-square and marking knife or pencil, mark out the ends of the mortise on both sides of the wood.

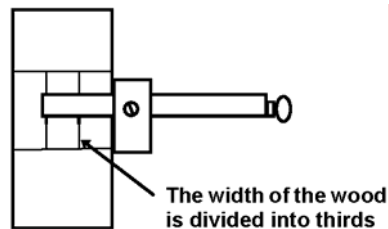
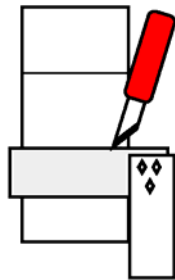

2. Using a mortise gauge mark out the sides of the mortise on both sides of the wood.

3. Hold the wood firmly on the bench top with a G-clamp. Use a mortise chisel and mallet to chop out about a 3mm depth of wood from the ends of the mortise.

Always have the flat side of the chisel blade facing the end of the mortise, this gives neat, clean ends to the hole.

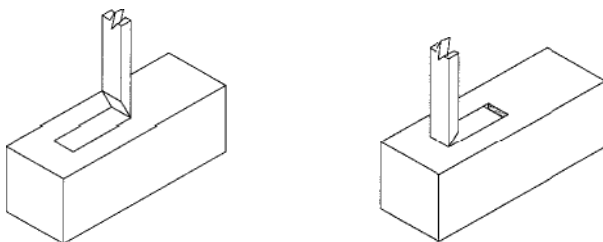

4. Place the chisel 3mm back from the last cut and hit down to a depth of about 3mm and lever out the waste. Repeat this along the mortise. Continue taking out layers until you reach half the depth, then turn the wood over and repeat steps 3 and 4.

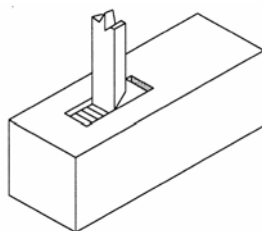

5. Using a try-square and marking knife or pencil, mark out the shoulder lines for the tenon all the way round the wood. The line should be the thickness of the wood plus 1mm from the end.

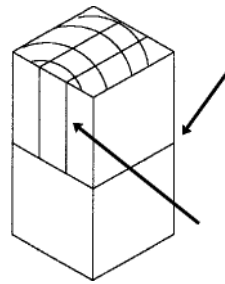

6. Use the mortise gauge, set as it was for the mortise. Mark parallel lines up both sides and across the top of the wood

7. Angle the wood in a vice and saw to the shoulder line. Angle the other way and repeat.

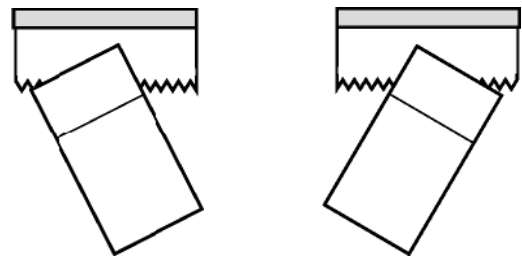

8. Place the wood upright in the vice and saw down to the shoulder line. This method helps to stop the saw straying from the lines.

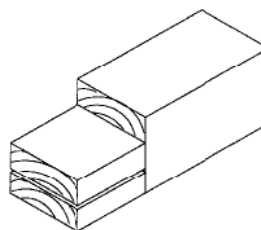
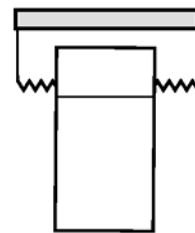

9. Hold the wood horizontally on a sawing board and saw off the waste to the shoulder lines with a tenon saw. Place the blade on the waste side of the line.

10. Gently try fitting the joint together. If you force it the mortise wood will split. If the tenon is too large then pare a small amount off it with a chisel.

**Note:** Fitting can take some time.

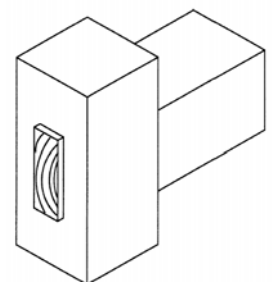

The part of the tenon poking out can be planed flush when the joint is glued.

**CUTTING A HOUSING JOINT**

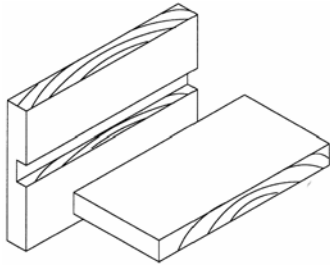

1. Using a try-square and marking knife or pencil, mark out the position of the housing. The lines should be the same distance apart as the thickness of the wood going into the joint.

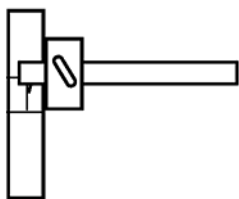
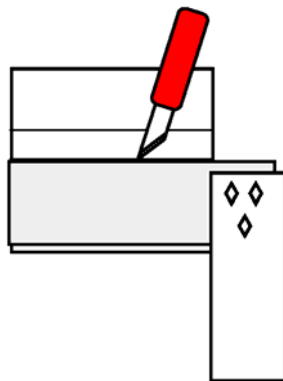

2. Using a marking gauge scratch the line that shows the bottom of the housing groove on both edges.

3. Clamp a piece of straight edged waste wood in line with one of the groove lines and using the waste wood as guide, saw down to the bottom of the housing groove. Repeat for the other line.

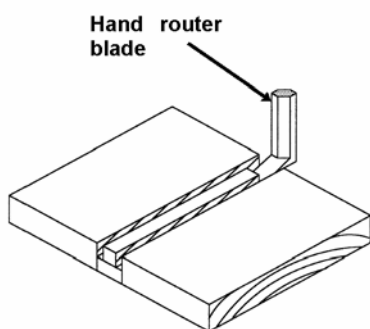
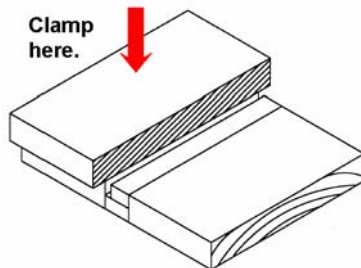

4. Edge clamp the wood and use a hand router to cut away the centre section.

**Note:** For a clean finish only try and cut up to 1mm at a time. Lower the blade 1mm between each pass.

5. The joint should now fit together.

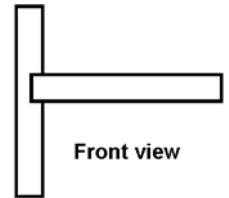

**Stopped Housing Joint**

To cut a stopped housing joint the end of the groove needs to be cut out like a mortise, so that the groove lines can be sawn without the saw going across the whole width of the wood.

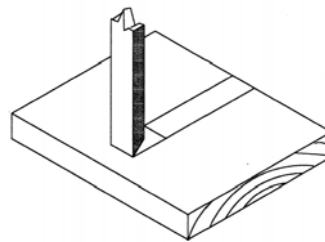

**A)** Using a mortise chisel and a mallet, chop out the last 25mm of the groove, to the full depth.

**B)** Use a piece of waste wood as shown in (3) to guide the saw. The hole allows the saw to move a short distance backward and forward.

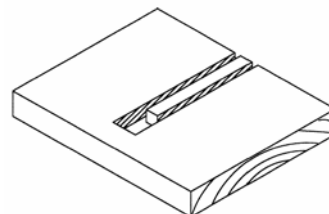
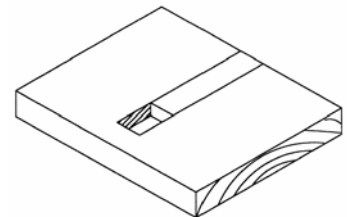

**C)** Use a hand router as in (4) to complete the groove

**D)** The shelf or divider will need to have the front corner cut away so that it fits flush with the front of the housing. A marking gauge can be used to mark out all the lines for this.

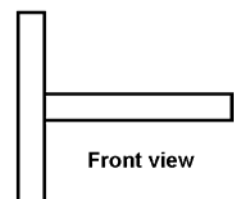
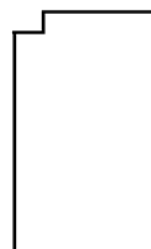

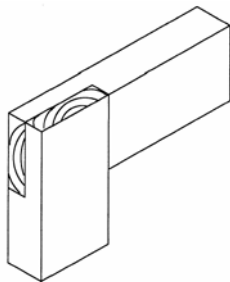
**CUTTING A CORNER HALVING JOINT****Corner Halving**

1. Using a try-square and marking knife or pencil, mark out the shoulder line on one side and both edges of both pieces of wood.

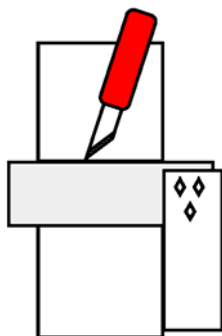

3. Angle the wood in a vice and saw to the shoulder line. Angle the other way and repeat.

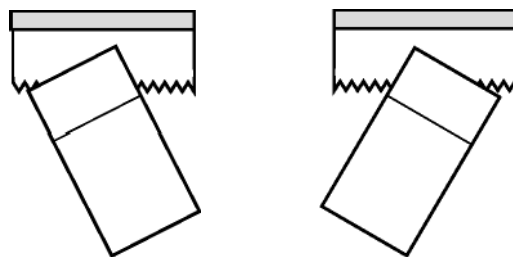

4. Place the wood upright in the vice and saw down to the shoulder line. This method helps to stop the saw straying from the lines.

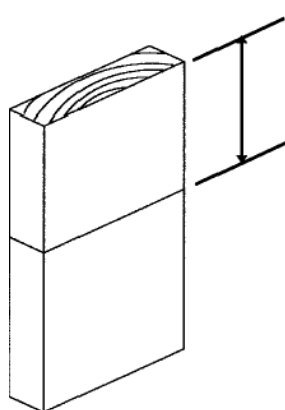

This dimension should be the width of the wood plus 1mm.

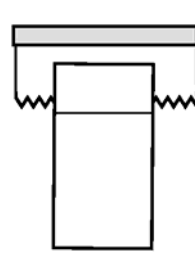

2. Using a marking gauge, mark out a half-thickness line, up the edges and across the end of the joint.

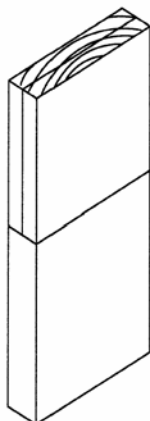
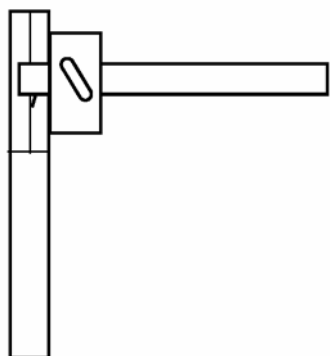

5. Hold the wood horizontally on a sawing board and using a tenon saw, saw off the waste. The saw blade should be placed on the waste side of the shoulder line.

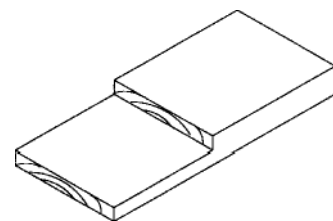

7. The overlapping parts can be planed flush after the joint has been glued together.

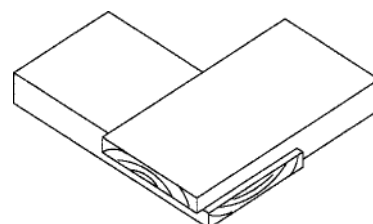

## CUTTING A TEE HALVING JOINT

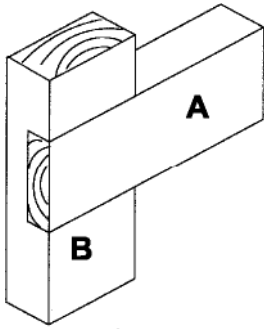

1. Part 'A' can be marked out and cut in the same way as for a corner halving (see worksheet 16d)

2. On part 'B', use a try-square and a marking knife or a pencil to mark the position of the joint. The lines should be on one side and both edges of the wood.

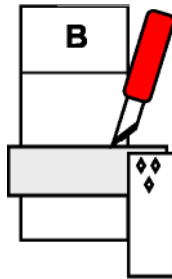

6. Repeat the above until the blade sits in the halfway groove and a slope is created.

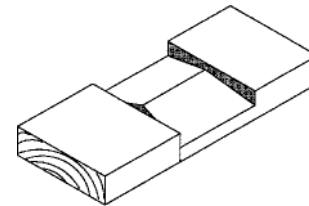
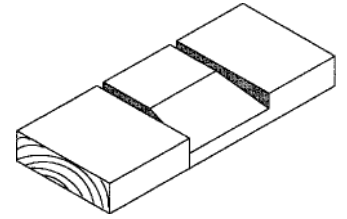

7. Turn the wood around and repeat steps 5 and 6.

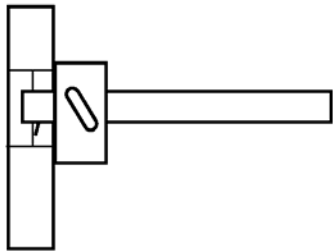

3. Using a marking gauge, mark out a half-thickness line, between the two cross lines on both edges.

8. Turn the chisel the other way up and then chop the top off the triangular waste. Repeat this until the joint has a level base.

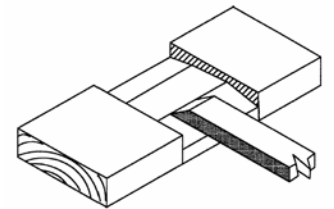

4. Hold the wood horizontally on a sawing board and use a tenon saw to saw two cuts on the inside (waste side) of each

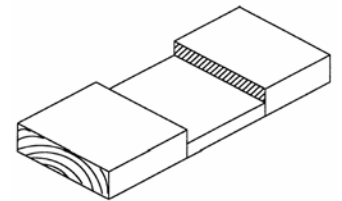
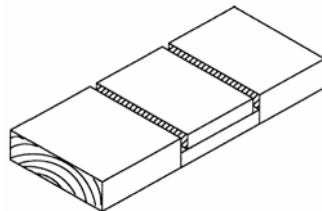

5. Hold the wood horizontally in a vice or clamp it to the top of a bench. Using a firmer chisel and mallet, place the blade with the flat side up, about 1mm below the top surface of the joint and chop a triangular piece of waste away.

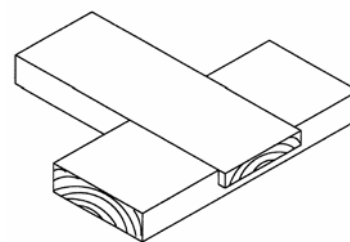

9. The overlapping part can be planed flush after the joint has been glued together.

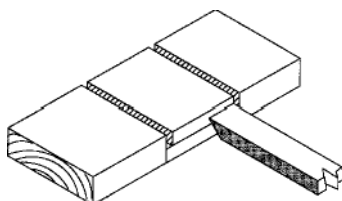

### Cross Halving Joint

Cutting the cross halving is the same as cutting part B twice.

When fitting, the sides of the recess may need paring with a chisel to help the joint fit.



## CUTTING A DOWELLING JOINT

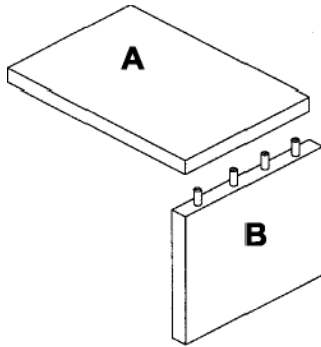

The most difficult part of cutting a dowel joint is lining up the holes. **This cannot be done by marking out with a ruler and pencil.** The natural inaccuracy of marking out will mean the holes are more likely to be out of line than in line. It is essential that a **Dowelling Jig** is used. Jigs for wide boards are very expensive and are not likely to be found in school, but making your own jig is not difficult.

## A school-made Dowelling Jig

Both parts are mild steel strip 15x3mm cross section

Holes marked out and drilled to the same diameter as the dowel before joining to the end plate.

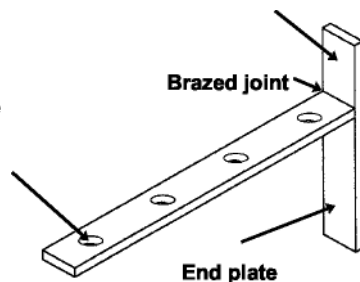

1. Cramp the jig to board 'B' with the long leg of the end plate running down the edge of the board. Drill vertical holes through the guide holes in the jig. **Hint:** to ensure that each hole is the same depth, wrap a piece of adhesive tape around the drill bit and stop drilling when the bottom edge of the tape touches the surface of the jig.

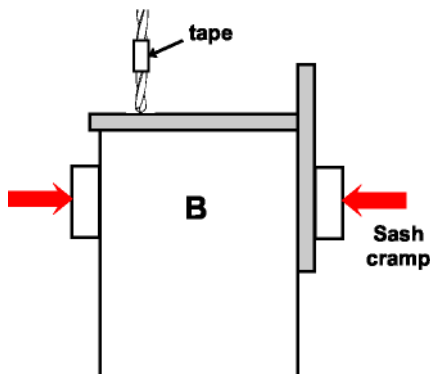

2. Turn the jig the other way up and cramp it along the end of board 'A'. Put new tape on the drill, making sure that the drill tip will not come out the other side of the board, then drill vertical holes through the guide holes in the jig (the hole's depth should be at least three quarters the width of the board to ensure a strong joint).

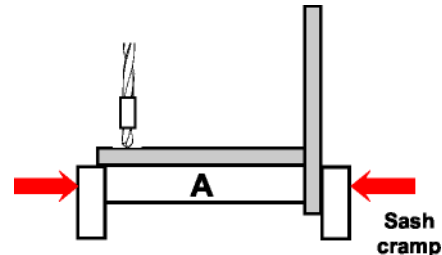

**Note:** If the jig is not turned the other way up then any inaccuracy in the lining up of the guide holes in the jig will be doubled. When it is turned the other way up the inaccuracies cancel each other out and all the holes will line up.

**Preparing the Dowel** Each dowel should be 1mm shorter than the combined depths of both holes.

**A)** To saw the dowel to length without it splitting hold it on a sawing board to provide support.

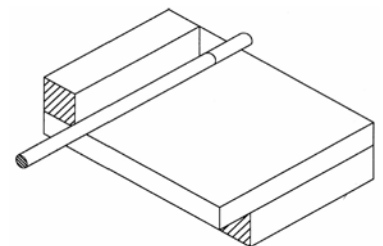

**B)** To stop the dowel from splitting and to make it easy to put it in the holes, the ends should be chamfered. This is best done by holding it at 45° and twisting it as it is rubbed over a piece of glasspaper laid flat on the bench.



**Safety tip:** Do not be tempted to chamfer the dowel by using a disc sander. The dowel is too short and you could receive a nasty graze from the disc.

## WOOD ADHESIVES

The use of adhesives is a form of **permanent** joining.

Most wood adhesives are made up of solid particles of glue being dissolved in a solvent (water or spirit). The solvent needs to evaporate (dry) before the adhesive works. The time this takes is called the **setting time** and the joint should not be handled until this time is up.

Strong joints rely upon the adhesive soaking into the wood before setting. It is therefore very important that the surfaces to be glued are freshly cleaned with glass paper to remove any dirt or oily residue left by touching the surface with your fingers. Any dirt or residue stops the adhesive from soaking in.

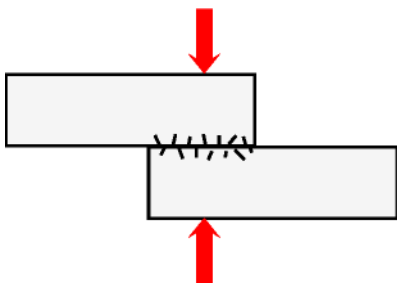

The glue soaks into the pores of the wood and then sets like lots of little fingers grabbing onto the wood on both sides. Using a **cramp** to hold the two halves of a joint together firmly helps to force glue into the pores of the wood. Cramping also holds the joint still while the glue is setting.

When the joint is cramped excess glue should squeeze out of the joint. If it doesn't, not enough glue has been used. The excess glue should be wiped away with a damp cloth quickly, before it sets.

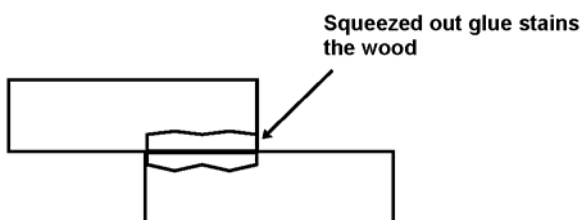

The squeezed out glue stains the wood white and the stain will show under any clear varnish that might be put on later.

**Tip:** Varnish the wood before you glue the parts together, the glue will not stain varnished wood.

**Warning:** Do not varnish the joint contact surfaces because the varnish will stop the glue soaking into the wood and result in a very weak joint.

**KEY WORDS** Adhesive: Cramp: Setting time: Toxic:

## Gap filling

Most wood glues do not fill gaps well because they soak into the wood. If a joint is badly cut and leaves a gap, glue the joint in the normal way and let it set. Now saw some waste wood of the same type and colour and collect the sawdust. Mix the sawdust with new glue to create a paste. The paste can now be forced into the gap so that it fills it completely and is sticking out a little. When the paste has set it can be sanded down flush with the wood surface.

Gap to be filled with sawdust and glue paste



## Contact glue

This is useful for joints where no sliding together is required e.g. lap joints. The glue is applied to both surfaces and they must be left apart for at least ten minutes (until the glue looks dry) to allow the spirit to evaporate. The joints can then be lined up and pushed together.

ADHESIVE	SETTING TIME	COMMENTS
PVA (polyvinyl acetate)	1 hour	Non-toxic, white, water-based glue for general use. Normally water resistant when set.
Synthetic Resin (Cascamite)	2 - 6 hours	Non-toxic, white, water-based glue. Used when extra strength is important. Waterproof when set.
Contact Adhesive (Evostick)	instant	Highly toxic, brown, spirit based, waterproof glue. Used on non porous surfaces. Must be used in a well ventilated area. DO NOT sniff the glue.
Glue sticks	15 seconds	Non-toxic plastic. Not very strong. Only useful for spot gluing. Excess glue difficult to clear away.

1. What type of jointing are adhesives used for?
2. Explain the term 'setting time'.
3. How is an adhesive made up?
4. How does a water-based adhesive work on wood?
5. What preparations should be made before using an adhesive?
6. What is the purpose of cramping a joint together?
7. How can you avoid a glue stain showing through a clear varnish finish?
8. How can you use glue to fill a gap in a badly cut joint?
9. Which adhesive would you choose for holding together a garden seat and why would you choose it?
10. What precaution should you take when using contact adhesive?

**MECHANICAL FIXINGS FOR WOOD**

Nails, pins and screws, used without glue, provide a semi-permanent method of jointing.

**Nails and Pins**

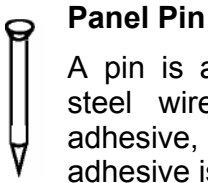

**Panel Pin**  
A pin is a small nail, made from rigid mild steel wire. Pins are normally used with adhesive, to hold the joint together while the adhesive is setting.

**Pin Punch**



A pin punch is used with a hammer to drive the head of the pin below the wood surface. The hole above the pin head can then be filled with a wood filler so that the pin cannot be seen.

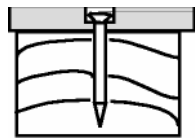

**Round Wire Nail**

Made from galvanised mild steel the wire nail is used for exterior heavy construction. The nail head cannot be hidden. Nails are normally used without any adhesive and rely upon friction between the nail shaft and the surrounding wood to hold them in.

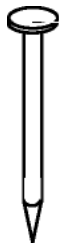

**Oval Brad**

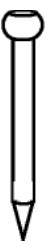

The shaft is oval in shape so that when correctly used it is less likely to split the wood. The oval brad can be hidden by using the same method as hiding a pin.

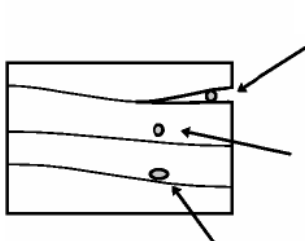

Split caused by placing the nail too close to the end of the wood.

Nail placed at least nine times its diameter from the end of the wood to avoid splitting.

Oval Brad placed with the oval length in line with the grain of the wood to avoid splitting.



**Claw Hammer**  
For general work and removing headed nails

**Cross Peen Hammer**  
For small nails and pins.

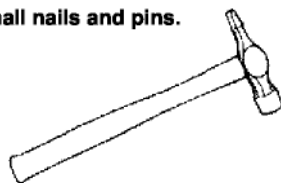

**Dovetail Pinning**



Pins and nails driven in at an angle are less likely to pull out in use. This is known as Dovetail pinning.

**Safety hint**

Small pins are difficult to hold without the danger of hitting your fingers with the hammer. Push the pin through a piece of card and hold the card well away from the pin. Once the pin is held in the wood the card can be torn away.

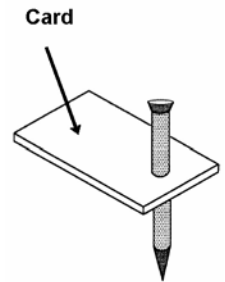

**Screws**

**Countersunk Head Screw**



Made from mild steel or brass. Used when the head needs to be flush with the surface of the wood. The screw can be slot-head for flat blade screwdrivers or crosshead for pozidrive screwdrivers.



Slot-head



Cross-head

**Roundhead Screw**

Commonly in brass or mild steel covered in black lacquer or chromium plate. Used for extra strength and when the head can stick out from the surface of the wood.



**Chipboard Screw**



Especially designed, with two spirals, for use on chipboard so that it does not pull out easily. It is now very popular for general use because it requires only half the number of turns of the screwdriver to tighten it.

**Preparation for using a screw**

- A) Drill a pilot hole of smaller diameter than the thread
- B) drill a clearance hole of larger diameter than the thread in the joining wood only
- C) If required of larger diameter than the clearance hole.

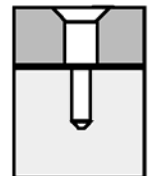
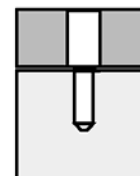
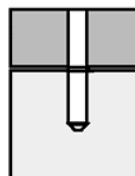

**Hinges**

Hinges come in a large range of styles, sizes and materials.

**Butt Hinge**

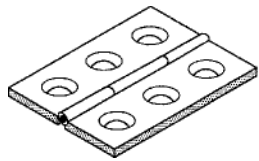

The basic hinge, commonly made from mild steel, brass or nylon. Used for hinging doors and lids etc.

Butt hinges are positioned so only the spine of the hinge can be seen.

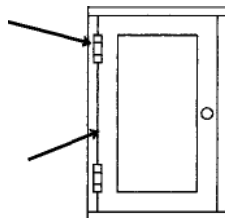

To avoid a gap between the door and the side, the hinge is 'let' into the wood on both sides.

**Letting in a hinge**

1. Place the hinge in position on the wood and mark around the edge.

2. Use a marking gauge to scratch a line showing the thickness of the hinge flap.

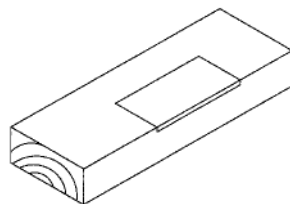
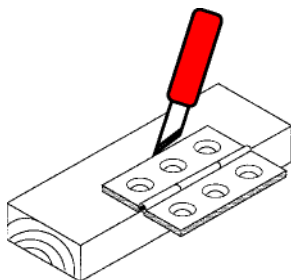

3. Using a firmer chisel and mallet chop around the outline to the depth of the flap

4. Chop out the waste and pare the bottom level.

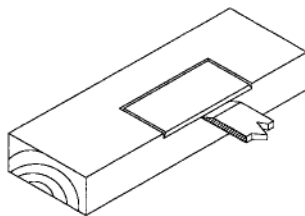
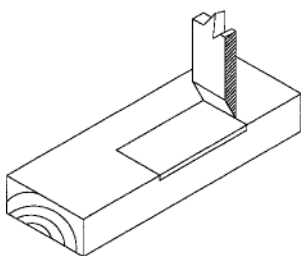

5. The hinge flap should now be flush with the surface when placed in the recess and screwed down.

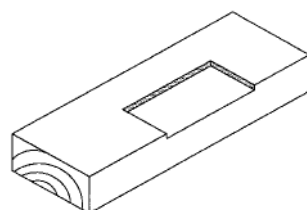

**Knock Down Joints (KD Joints)**

KD joints are non-permanent and are used for flat-pack furniture that is designed to be put together by the purchaser.

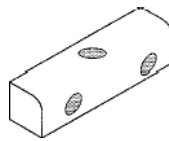

**Plastic Modesty Block**

The block is used without glue.

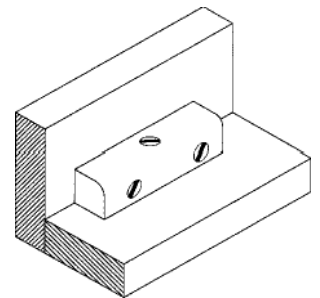

**Brass or plastic dowel**



**Bolt & Cross Dowel**

Cross dowel placed in drilled hole

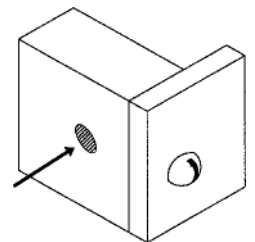

**KEY WORDS** Oval Brad: Countersunk: Butt hinge

1. What holds a pin or nail in place?
2. What is a nail made from?
3. Describe how the heads of pins can be 'hidden'.
4. How can you prevent nailed wood from splitting?
5. Sketch a claw hammer. What are the two jobs it is designed for?
6. Show how you can hammer in small pins safely?
7. What is the difference between a chipboard screw and a conventional wood screw?
8. Illustrate the stages of preparing a screwed joint.
9. Show how you can prevent a hinged box lid from having a gap between itself and the box when it is shut.
10. What does the term KD joint stand for?
  - A KD joints are often used in flat-pack furniture. Design an information sheet to show how: i) A modesty block is used. ii) A bolt & cross dowel is used.
  - B Hunt down and sketch at least **four** different types of hinge.

**SHAPING WOOD - LAMINATING**

Laminating is a method used to:

- a) create a curved wooden shape.
- b) create thin, rigid and tough flat material.

A laminate is made up of layers of veneers (thin sheets of natural wood) glued one on top of another. Unlike plywood, the grain of each sheet is normally lined up in the same direction.

**Rigidity and Toughness**

A laminated strip of wood is far more rigid and tougher than the same size strip of natural wood.

**Rigidity**

When a strip of natural wood is bent, the top surface stretches and the inner surface compresses

Natural Wood

Both top and bottom surfaces are the same length



Top surface stretches



Inner surface compresses

For a strip of laminated wood to bend in the same way, each layer must be able to slide over the layers above and below. Strong glue prevents the sliding from happening, so the strip is rigid.

Each strip is the same length

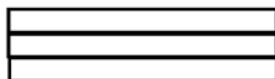

When bent, each strip remains the same length, the set glue must have allowed slippage to occur.

This cannot happen without the glue line breaking up and the laminate falling apart!



The same happens in reverse, if the strips are glued together in a bend, it is not possible to straighten the bend after the glue has set.

**Toughness**

A laminated strip is tougher than solid wood because a crack that starts on one side of the strip is stopped by the glue line and does not go all the way through. (unless of course the force is too great, every material has a limit)

A crack in solid wood will travel all the way through

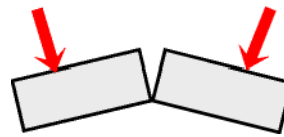

A crack in laminated wood will tend to stop at the glue line

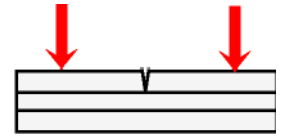

**Laminating a flat strip**

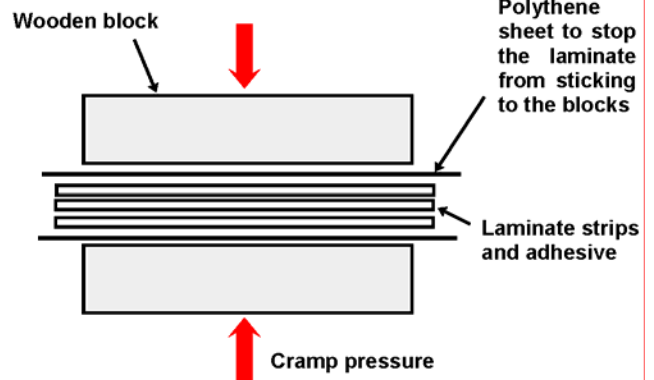

**Laminating a curved strip**

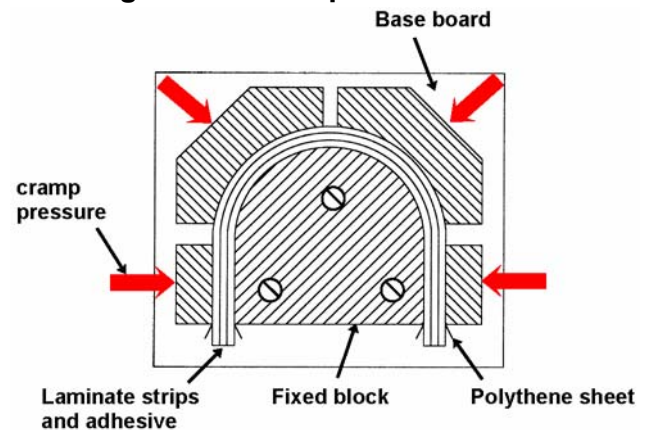

1. What are the parts of a wood laminate?
  2. How is it that a laminate is more rigid than solid wood?
  3. Show how laminated wood is tougher than solid wood.
  4. Illustrate the set-up for laminating a flat strip.
  5. Illustrate the set-up for laminating a curved strip.
  6. What is the purpose of using polythene sheeting when laminating?
- A. Design a jig to allow the chair side shown to be laminated.



**KEY WORDS** Laminate: Rigidity:  
Toughness:



## WOOD FINISHES

Wood has a **finish** applied for the following reasons:

- To stop the wood from absorbing moisture, so that it is less likely to become stained and also less likely to warp.
- To protect against rot and insect attack.
- To improve the appearance of the wood's surface.

### Preparation

The wood must be made clean and smooth before the finish is applied.

### Planing

A smoothing plane with the blade set to cut tissue thin shavings will give the smoothest finish.

**Note:** Do not use glass paper after planing because this will roughen the surface again.

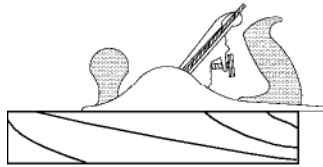

### Glass-papering (sanding)

Glass paper comes in various grades of coarseness:

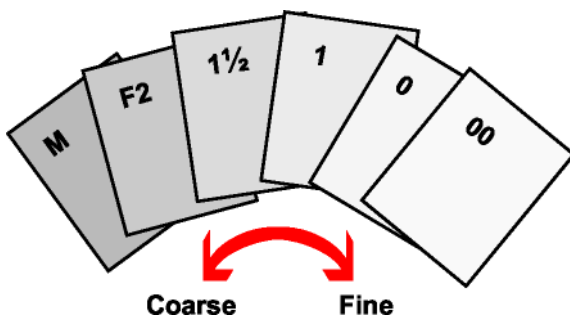

A coarse paper should be used first, then a medium paper and finally a fine paper.

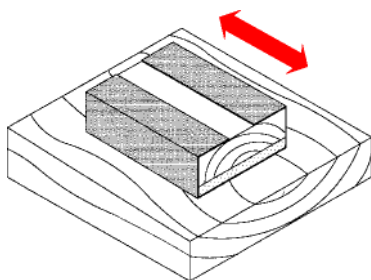

Always sand in the direction of the grain

The glass paper should be wrapped around a sanding block. A proper block is made of cork or has a cork layer stuck to the bottom, cork is a soft springy wood and can help stop the glass paper wearing away too quickly. However, a piece of waste wood can be used instead.

**Note:** Always sand backwards and forwards in the direction of the grain. Any sideways or circular movement will put deep scratches in the wood that are difficult to remove.

If you are using an electric, hand held sander, move the whole machine only in the direction of the grain.

### Preservative

Wood used outside or in damp conditions is likely to rot unless preservative is applied. Wood can be purchased that has had preservative forced into it under pressure (Tanalising). The preservative will last the lifetime of the wood. If untreated wood is used, it can have preservative painted or sprayed onto it, so that it soaks in to the surface. The preservative can be oil based (Creosote) or spirit based. This sort of preservative needs to be replaced every few years because rain gradually washes it out of the wood.

### Stain

Stain (colouring) is used to change the colour of light woods to make them more interesting or to blend in with darker woods. It does not hide the grain. Stain is normally applied by rubbing it onto the surface with a soft clean cloth. Stain will not protect the wood so needs a finish on top. It is possible to buy a 'combined stain with varnish', this can give a very tough water resistant finish, for use inside and outside.

Apply the stain in small circular movements to even out the colour.

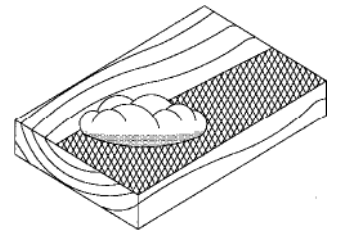

### Varnish

Plastic based clear varnishes (polyurethane and acrylic) are sold in:

**Matt** finish - non shiny

**Satin** finish - slightly shiny

**Gloss** finish - very shiny

A clear varnish allows the pattern of wood grain to show through and will normally darken the wood, giving it a deep, interesting colour. It is also water and heat resistant.

The varnish can be applied with a brush (brush in line with the grain for the best finish). At least two coats are required.

- Apply the first coat thinly and let it set fully. This coat soaks into the pores of the wood and then sets. The wood is now sealed.
- Use a fine grade of glass paper to lightly sand the surface because the first coat tends to make the surface rough as it sets.
- Apply the second coat also thinly, check for any runs or drips and let it set to a smooth finish.

**Note:** Varnish should not be applied to oily woods such as teak because after a short time it will flake off.

## Wax

Silicone wax gives a medium gloss finish. Like varnish, it allows the grain of the wood to show through. Wax must only be applied on sealed wood, otherwise it soaks in and never shines.

- i) Apply a coat of cellulose sanding sealer (this sets in five minutes if applied thinly).
- ii) Use a clean cloth to rub a thin coating of wax onto the surface.
- iii) Use a clean soft cloth to buff the wax to a shine. Add at least another two coats of wax and buff each time.

## Oil

Cooking oil (vegetable) or special teak oil can both be used to give a water and heat resistant, satin finish. An oil finish does not crack or peel off.

Oil can be applied with a clean cloth directly onto the smooth, unsealed surface of the wood. Five to ten minutes should be allowed between coats to allow each coat to soak into the wood. Three coats is normally sufficient.

To maintain a good finish oil should be applied regularly about every six months.

Oily woods are best finished with teak oil, a mixture of linseed oil, waxes and turpentine.

## Paint

Paint provides a water resistant, coloured protective coating.

All paints give a better finish if a number of thin coats are applied rather than one thick coat.

### Traditional gloss

An oil based paint. Three coats are required:

1. A **primer** coat. A primer is a paint that sets quickly and seals the pores in the wood.
2. An **undercoat** coat. Undercoat paint contains a lot of pigment (colour) to stop the original surface showing through.
3. A **gloss** top coat. Gloss paint contains less pigment and more clear varnish to provide the shine. If the paint also contains polyurethane it will have a tough, scratch resistant finish.



## Acrylic gloss

A water based paint that only requires a primer and top coat. The gloss is not as shiny, or the finish as scratch resistant as a polyurethane paint.

## Emulsion

A water based paint that often contains vinyl to make it more water resistant and easier to wipe clean. Normally only two coats are required, the first coat seals the wood like a primer. The finish can be matt or satin only, gloss is not an option.

**Don't** apply varnish or paint too thickly, many a good piece of work has been spoilt by poor painting.



## French Polish

This is a traditional polish made from shellac, used on high quality furniture and antiques. It gives the best looking finish of all, but is very difficult to apply and is not water or heat resistant.

**KEY WORDS** Sealer: Matt: Satin: Primer: Undercoat:

1. Why is it necessary to apply a finish to wood?
  2. Describe the preparation method that gives the smoothest finish.
  3. Which grade of glasspaper would you use to complete your preparation for a finish to be applied?
  4. Describe the method you would use for sanding a wooden surface.
  5. What are the reasons for using a wood stain?
  6. In what forms can you purchase a clear varnish?
  7. Explain the stages required for varnishing.
  8. What are the advantages of an oil finish?
  9. Explain the reason why traditional painting uses three different coats.
  10. What are the differences between Acrylic paint and Emulsion paint?
- A** State which finish you would choose for the following wooden products and give reasons for your choice.

A jewellery box made from mahogany.

A garden bench made from oak.

A kitchen cupboard made from plywood.

A fruit bowl made from teak.

A mirror frame made from knotty pine.

**WOOD TURNING**

Natural wood products such as bowls, legs, spindles and lamp stands are turned on a lathe.

**Turning between centers**

This is the method used for turning legs and spindles.

The wood should be prepared by marking out an octagon on both ends and then planing the sides

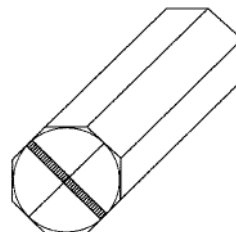
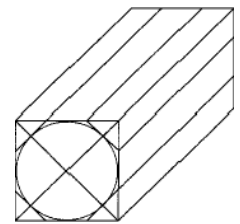

At one end a saw cut should be made to allow the teeth of the drive dog dig into the wood.

**The lathe set-up**

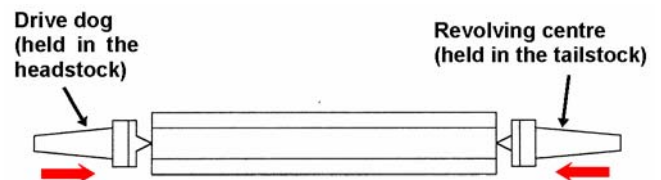

For all types of turning, the tool rest should be adjusted so that it supports the turning tool with its blade just above the centre line.

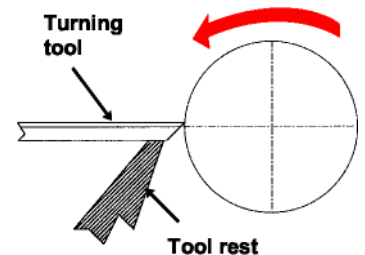

**Turning tools**

Turning is carried out by using using special chisels that have long blades and handles (so that they can be held safely and give good leverage).

**Gouge**

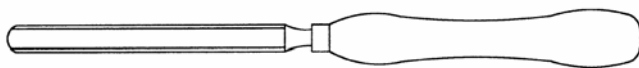

**Bowl turning**

The wood to be turned needs to be prepared by cutting it into an octagonal shape. A face plate is then centred and screwed onto the wood.

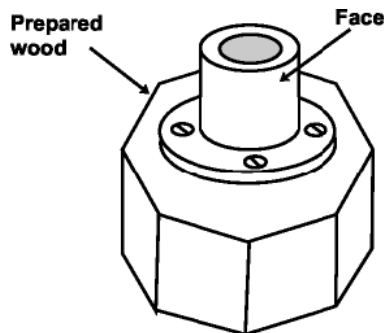

The face plate screws onto the spindle.

**The outside is shaped first**

The half finished bowl is then turned round and re-centred before the inside is shaped.

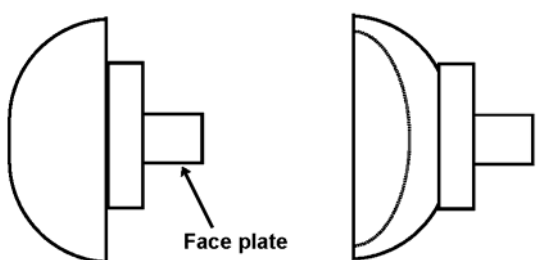

**Safety Notes:** Never attempt using a lathe until you have received instruction from your teacher.

Always wear goggles!

**KEY WORDS** Lathe: Headstock: Tailstock: Face plate:

1. Draw a diagram of a wood lathe and label the parts.
2. Why are the turning tools large?
3. How should a block of wood be prepared for turning it into a bowl?
4. What is the order in which a bowl is turned?
5. Show how a length of wood should be prepared for turning between centres.
6. Illustrate the set-up for turning between centres.
7. Show the position that the blade of a cutting tool should be placed in to cut efficiently.
8. What safety precautions should you take?

**WOODWORKING POWER TOOLS**

In industry and in the world of DIY (Do it Yourself), very few people use hand tools. They prefer the convenience and accuracy afforded by power tools. Unfortunately, most power tools are dangerous to use and therefore are not suitable for pupils to use in school.

**Power drill**

A quality drill will have variable speed so it can be slow for larger drill bits. Most drills have hammer action for use when drilling into brick and concrete. Cordless versions are available.

**Plunge router**

Used for cutting grooves, slots and shaping the edges of wood

Router cutter for cutting grooves and slots.

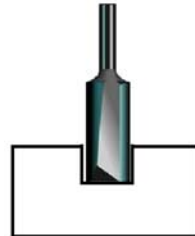

Router cutter for cutting rebates.

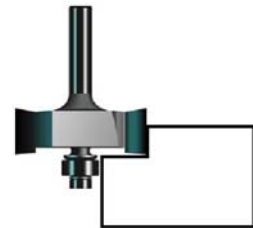
**Circular saw**

Used for sawing long straight cuts, especially useful for large manufactured boards. Can be set to cut at any angle up to 45°.

**Power planer**

Revolving blades can cut thicker shavings than a hand plane.

**Orbital Sander**

The glasspaper is moved in a circular motion to give a rubbing action. Useful on smaller areas.

**Jigsaw**

Used for cutting curved cuts in thin boards. Can be set to cut at any angle up to 45°. Cordless versions are available.

**Belt Sander**

The belt made from aluminium oxide, revolves like the tracks of an army tank. Useful for heavy duty work on large areas.





**COMMERCIAL PRODUCTION METHODS**

When producing large quantities of a product, a production line is set up to produce large numbers of each part and allow them to be put together as efficiently as possible. Automatic machines and computer controlled machines are an essential part of a modern production line.

**A Computer Controlled (CNC) Router**

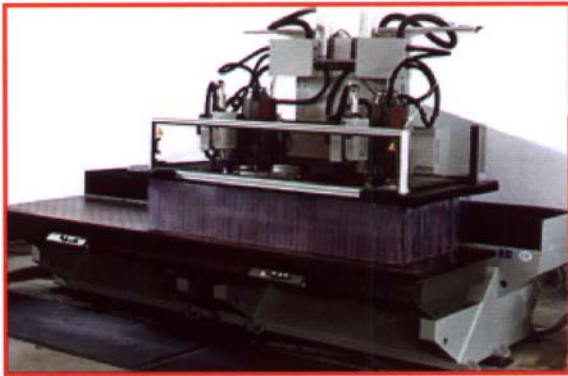

The bedhead shown below could be manufactured by the CNC router shown above. A rectangular board would be positioned on the machine. The router would then:

- a) cut the curved edge.
- b) mould the curved edge.
- c) drill the holes

All three operations happen without the operator doing anything.

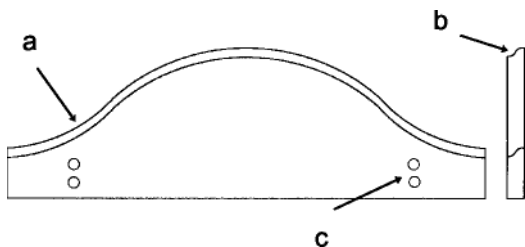

**Sawing**

Large scale sawing is done using **circular saws** or **band saws**.



**Circular Saw**

Used for cutting straight through the complete length or width of the wood



**Bandsaw**

Used for cutting curves or for cuts finishing part way through the length or the width of the wood.

**Planing**

The wood is held down and passed over revolving blades that take a cut from the underside.

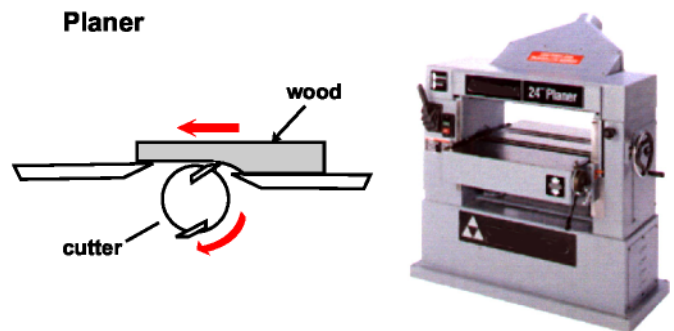

**Sanding**

The wood is passed under large moving belts made from abrasive cloth. The belts can be as much as 1.5 metres wide.

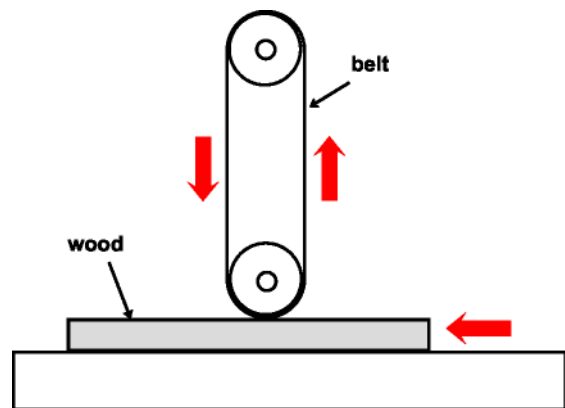

**Finish**

Varnish or paint is sprayed on, in a dust free atmosphere. This gives a very smooth and even finish.

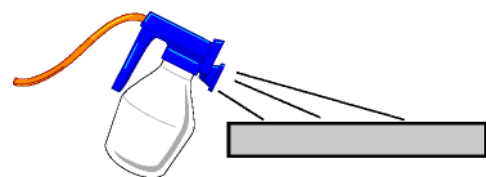

**A** Select a wood based product that you have recently completed and write a **workplan** as if it were going to be made commercially.



## SELECTING METALS

There are two classes of metals:

**Ferrous** - metals that **contain iron** and are affected by magnetism (apart from stainless steel).

**Non-ferrous** - metals that **do not contain iron** and are not affected by magnetism.

Metals can also be grouped into:

**Pure metals** - metals made up from only one chemical element e.g. copper or aluminium.

**Alloys** - metals made up from a mixture of elements, e.g. copper + zinc (brass) or lead + tin (solder)

### Alloying

Metals are alloyed to improve the qualities of the individual pure metals e.g. both copper and tin as pure metals are both soft metals that are easily bent and scratched. When alloyed together ( 90% copper plus 10% tin) they produce bronze which is hard, rigid and resists scratching. Bronze is used for our 'copper' coins.

### Corrosion

When choosing metals, resistance to corrosion may be an important factor.

Corrosion is caused by oxygen in the air combining with the atoms of metal, at the surface of the metal, to create a new chemical called an oxide, e.g. iron oxide is called **rust**.

In steel the rust layer is loose and can fall away; this exposes new atoms that will combine with oxygen to form new rust.

In non-ferrous metals the oxide layer is dense and does not fall away; this creates a barrier to the oxygen in the air and new corrosion occurs very slowly. The layer is called **tarnish**.



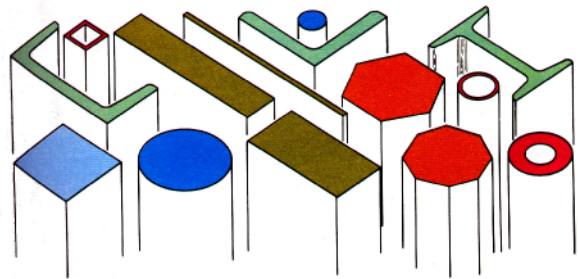

### Properties

Both physical and mechanical properties vary greatly between different metals and alloys and are an important part of the selection process. (see worksheet 5a)



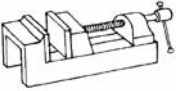





### Available forms

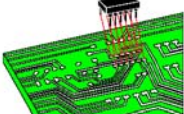

## FERROUS METALS

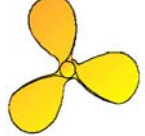
NAME	COMPOSITION	PROPERTIES	USES
Cast Iron	Iron + 3.5% carbon	Smooth skin with soft core, strong when compressed, self lubricating, cannot be bent or forged.	Vices, lathe beds, garden bench ends, car brake drums, etc 
Mild Steel	Iron + 0.15 - 0.35% carbon	Ductile, malleable & tough, high tensile strength, poor resistance to corrosion, easily welded.	Car bodies, washing machine bodies, nuts & bolts, screws, nails, girders, etc. 
High Carbon Steel (tool steel)	Iron + 0.8 - 1.5% carbon	Very hard, rather brittle, difficult to cut, poor resistance to corrosion.	Tool blades e.g. saws, chisels, screwdrivers, punches, knives, files, etc. 
High Speed Steel	Iron + tungsten chromium vanadium	Very hard, heat resistant, remains hard when red	Drills, lathe cutting tools, milling cutters, power hacksaw blades etc. 
Stainless Steel	Iron + chromium nickel magnesium	Tough and hard, corrosion resistant, wears well, difficult to cut, bend and file.	Cutlery, sinks, teapots, dishes, saucepans, etc. 

## NON-FERROUS METALS NAME

NAME	COMPOSITION	PROPERTIES	USES
Aluminium	pure metal	Good strength/weight ratio, malleable and ductile, difficult to weld, non-toxic, resists corrosion. Conducts heat and electricity well. Polishes well.	Kitchen foil, saucepans, drinks cans, etc. 
Duralumin	aluminium + manganese + magnesium	Stronger than pure aluminium, nearly as strong as mild steel but only one third the weight.	Greenhouses, window frames, aircraft bodies, etc. 
Copper	pure metal	Tough, ductile and malleable. Conducts heat and electricity well. Corrosion resistant, solders well. Polishes well.	Electrical wire, central heating pipes, circuit boards, saucepan bases 
Brass	copper + zinc	Quite hard, rigid, solders easily. Good conductor of heat and electricity. Polishes well.	Water taps, lamps, boat fittings, Ornaments, door knockers. 
Bronze	copper + tin	Tough, strong, wears very well, good corrosion resistance.	Coins, wheel bearings, statues, boat fittings 
Tin	pure metal	Weak and soft, malleable and ductile, excellent corrosion resistance, low melting point.	Solder (with lead) Coating over mild steel (tin can) 
Lead	pure metal	Soft, malleable, very heavy, corrosion resistant, low melting point, casts well, conducts electricity well.	Roof covering, Solder (with tin) Car battery plates 
Zinc	pure metal	Poor strength/weight ratio, weak, ductile and malleable, low melting point. Casts well.	Coating over mild steel (galvanising) Die castings used in cars e.g. Carburettor 

1. What is the difference between ferrous and non-ferrous metals?
  2. What is an alloy and what advantages does it have over pure metal?
  3. What is the difference between the corrosion of ferrous and non-ferrous metals?
  4. What are the differences between mild steel and tool steel?
  5. What is the main advantage of using stainless steel instead of mild steel?
- A** List as many objects, or parts of objects, that you can find at home that are made from stainless steel.

6. Why is duralumin used in aircraft?
  7. What property of copper makes it suitable for saucepan bases?
  8. Why is copper used for water pipes but not the taps on the end of the pipes?
  9. Which properties of bronze makes it suitable for making into coins?
  10. Why do you not get everyday objects made from solid tin?
- B** Which metal would you choose to make the following objects from and why? Wheelbarrow body: Cheese grater: Filing cabinet: Spanner: Drawer handle.

**MARKING OUT METAL**

Pens and pencils do not work well on metal, they rub off easily and don't show up well. Marking out is shown by scratched lines. To help the scratches to show up, before marking out, the surface of the metal can be covered with a thin layer of a quick drying ink called **Engineer's Blue**. Marking out tools scratch away the blue layer to show the contrasting metal colour underneath.

Before marking out, the metal should be prepared by filing two **datum edges**, from which all measurements are made. These edges should be perfectly straight and be at 90° to each other.

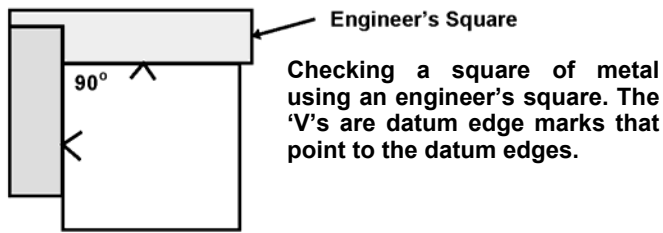

**Scriber** - used to scratch lines



**Centre Punch** - when hit with a hammer, it is used for making indents that position divider legs and drill points and stop them slipping.

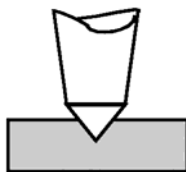

**Dividers** - used for scratching circles and arcs.

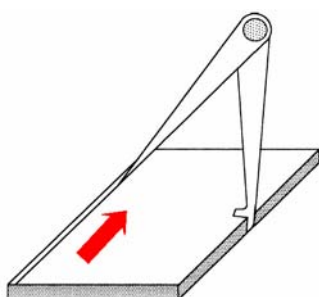
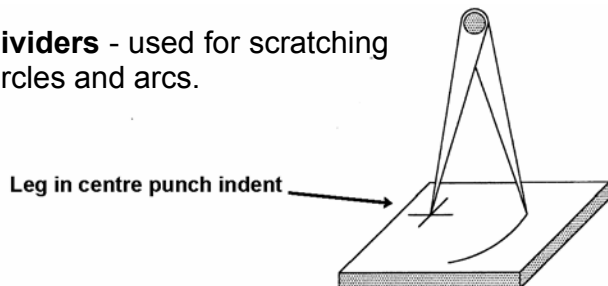

**Odd-leg Callipers**

Used for scratching lines parallel to a datum edge

**Scribing Block** - a fully adjustable device for holding a thin scriber used for scratching lines parallel to a surface.

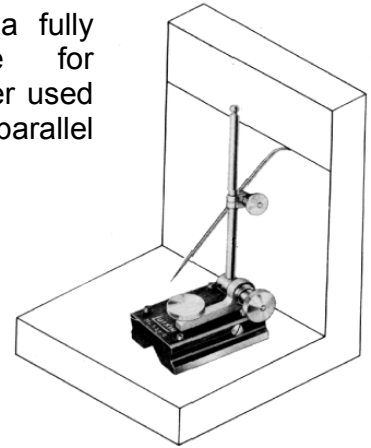

**Combination Square**

The photo shows all three heads on the rule. In use, only one head at a time would be on the rule.

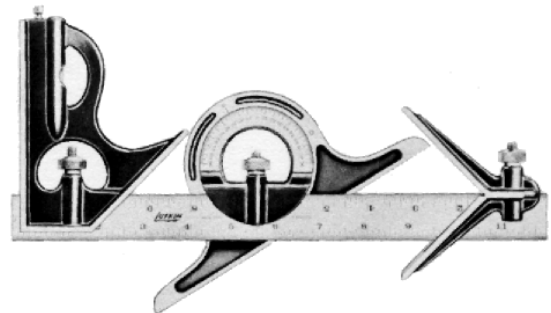

**Centre square** being used to find the centre of a disc. With the disc edges touching the arms, draw two lines at different angles, where they cross is the centre.

The angle head being used to draw a line at a set angle.

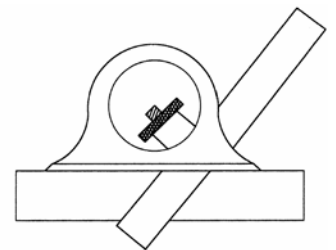
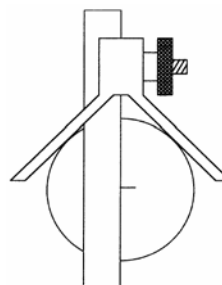

1. Which tools are used to scratch lines on metal?
2. How can scratches on metal be made to show up more clearly?
3. How is the pivoting leg of a pair of dividers stopped from sliding over the surface of metal?
4. Which tool would you use for marking a line parallel to a long edge?
5. What is the 'odd-leg' for in a pair of odd-leg callipers?
6. Why is a scribing block adjustable?
7. Why is a combination square called 'combination'?
8. Show how the centre square is used to find the centre of the end of a length of round bar.
9. Show how you can scratch a line at an angle of 25° to the edge of a bar of metal.
10. Show how the 'square' head can be used to scratch a line at right angles to the edge of a bar of metal.

## SHAPING METAL – WASTING

## SAWING

**Hacksaws** are used for hand sawing metals. The frame is adjustable to take blades of different length.

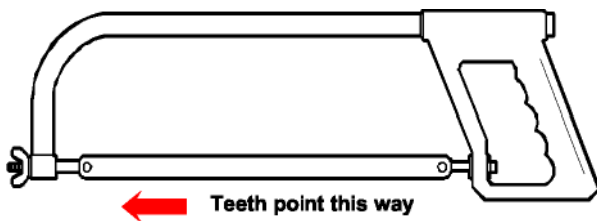

## Hacksaw Blades

The blades can be easily replaced when worn. Flexible, **High Carbon Steel** blades are used for general work on mild steel and non-ferrous metals. Rigid, **High Speed Steel (HSS)** blades are used for cutting hard steel.

Blades can be purchased with different size teeth:

**Coarse** - 14 or 18 TPI (teeth per inch) - thick metal.

**Medium** - 24 TPI- general work.

**Fine** - 32 TPI - thin metal.

If a coarse tooth blade is used on thin metal, the metal will catch between the teeth and the blade will jam.

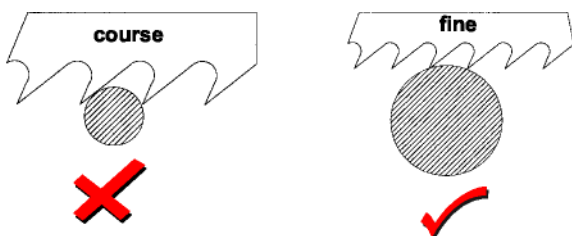

For long cuts, the blade can be attached at right angles to the frame, so that the frame does not get in the way.

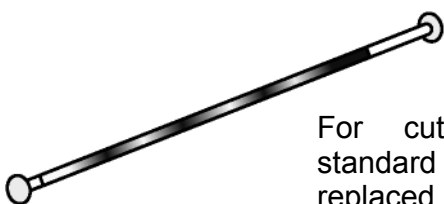
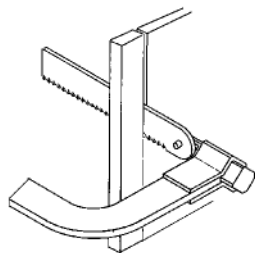

For cutting curves, the standard blade can be replaced by a **Tension file**, a round file held in the frame by special clips.

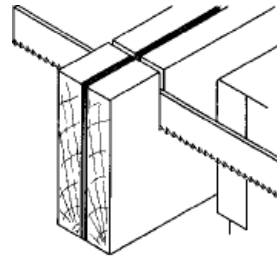

Thin metal can be cut easily by sandwiching it between two pieces of wood and then sawing through both the wood and the metal.

Thin wall tubing will collapse unless it is supported by placing a close fitting piece of dowel inside. Both the tube and the dowel are sawn.

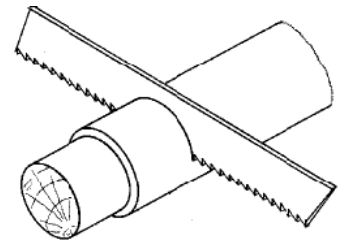

To stop the saw blade from sliding over the metal when starting a cut, use a triangular file to file a groove on the waste side of the line. The saw teeth should fit into the groove.

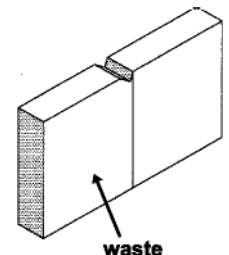

1. Why is a hacksaw frame adjustable?
2. Specify the blade that you would use for cutting 50mm off a 200mm length of 3mm diameter mild steel.
3. Why should a 32TPI blade be used for cutting thin metal?
4. Show how you would set up the hacksaw to cut a long strip off a sheet of brass.
5. What would you use to cut a curved cut in a sheet of copper?
6. Illustrate how you would cut a thin sheet of aluminium without it bending.
7. How can you solve the problem of holding and sawing a length of thin walled brass tubing without it getting squashed?
8. How can you start to cut a piece of mild steel in exactly the right place?



**FILING METAL**

Files are used for removing small amounts of metal and for smoothing a surface after it has been sawn. They are made from **High Carbon Steel** and come in many shapes, sizes and grades of cut.

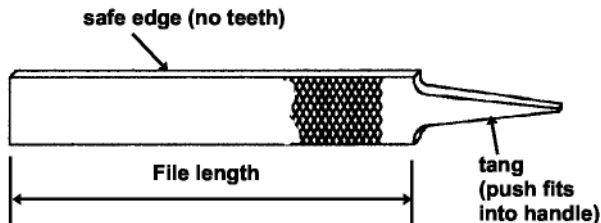

The most common files are named after their cross-section.

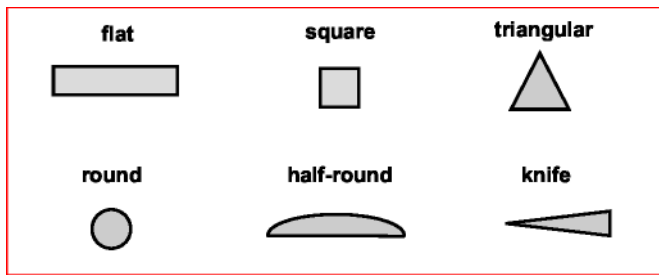

The roughness of a file is known by its **cut**.

**Bastard Cut**



Used first to get rid of most of the waste quickly. Leaves a rough finish.

**Second Cut**

Used to file closer to the line and for general work. Leaves a reasonably smooth finish.

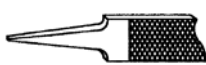

**Smooth & Dead Smooth Cut**



Used to file to the line and to provide a smooth finish.

**Needle files (Swiss files)**

These are small, dead smooth cut versions of normal files, cast with solid handles. They are used for fine work.



**Safe-edge Files**

Some flat files have a safe-edge. The safe-edge is useful to use when filing into a corner. It stops the file from filing into the other surface.

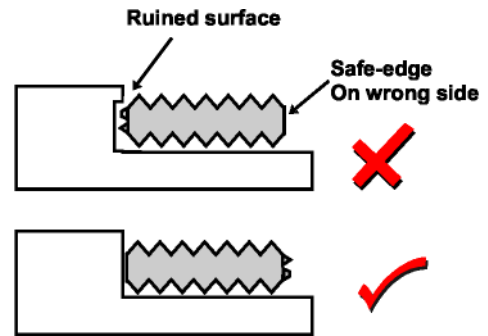

When filing a long edge, push the file forwards and slide it sideways at the same time.

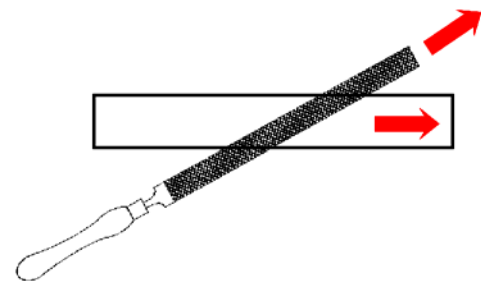

**Drawfiling**

Drawfiling is using the file sideways to give a very smooth finish to an edge.

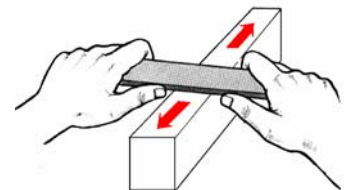

**Safety Note:** Never use a file without a handle, or with a loose handle, because the tang is likely to go into your hand when you push the file forwards.

1. What is the purpose of a file's tang?
  2. Draw the cross-sections of **six** of the most common types of file.
  3. What are the three cuts of file that you might use when filing a piece of mild steel to a marked line? What order would you use them in and why?
  4. Illustrate the use of the safe-edge of a file.
  5. How can a narrow file be made to smooth a large surface?
  6. Name and illustrate the filing method that gives the smoothest finish.
- A** Create a safety poster, showing what can happen if a file is used without a handle or with a loose handle.

**KEY WORDS** Tang: Half round: Safe-edge: Drawfiling



**DRILLING METAL**

Metals are drilled by **Jobber Drill Bits**, made from HSS.



The smaller diameter bits have a straight shank and are held in a **chuck**. The larger diameter bits have a tapered shank and are held directly in the pillar drill spindle. The thin part at the end locks into the spindle and cannot slip under pressure, like a straight shank could in a chuck.

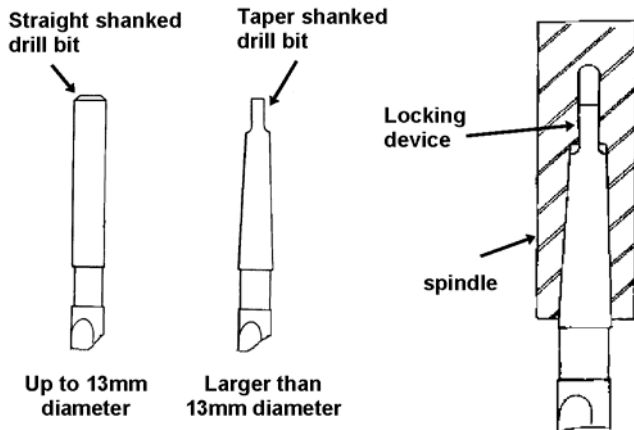

**A 'Jacobs' Chuck**

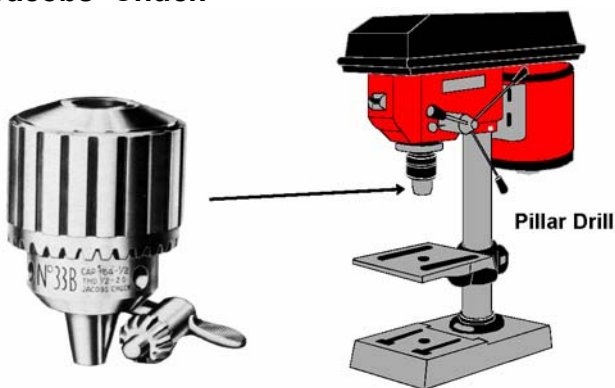

**Note:** For efficient cutting - Small diameter bits should turn at a fast speed. Large diameter bits should turn at a slow speed.

**Pilot Holes**

For holes in metal of 8mm diameter or larger, it is better to use a smaller drill bit first (4 or 5mm dia.). The smaller drill is less likely to wander off the centre punch mark. It also provides a hole that can guide (pilot) the larger drill.

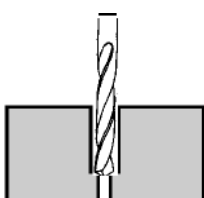

A pilot hole guiding a larger drill bit

**Depth stop**

The depth stop on a pillar drill is useful for drilling holes to a given depth and for drilling a number of holes that have to be the same depth. The adjusting nuts hit the stop and cannot move down any further.

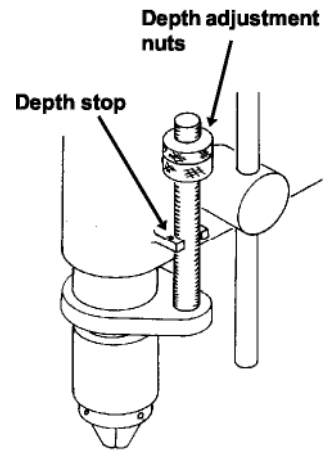

**Countersink Bit**

The bit is made from HSS. It is used to widen a previously drilled hole so that a countersunk screw head or rivet head can lie level with the surface.

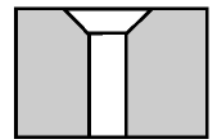

**Cone Bit**

Used for cutting and enlarging holes in thin sheet metal. This design does not catch in the metal and gives perfectly round holes.

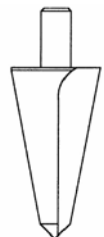

**Hand Vice**

A hand vice should be used to safely hold thin metal (up to 3mm thick), while it is being drilled.

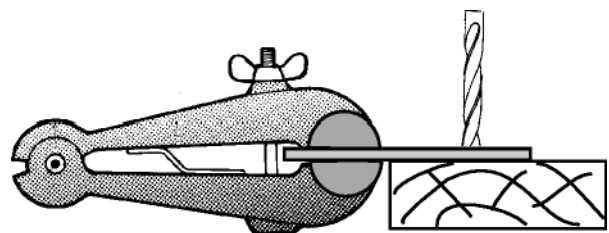

**KEY WORDS** Shank: Chuck: Pilot hole: Depth stop: Hand Vice: Cone bit:

1. What is the purpose of a chuck on a pillar drill?
2. What is the advantage of the taper shank design for larger diameter drill bits?
3. Explain what a pilot hole is used for.
4. You need to drill three holes that are 6mm diameter and 10mm deep. How can you be sure that they will be identical?
5. A jobber bit will cut a near triangular hole in thin sheet metal, instead of a round hole. How can you deal with this problem?
6. Illustrate a way of holding thin metal safely for drilling.

## CHISELLING

Chisels for metal are known as **Cold Chisels** and are made from High Carbon Steel.

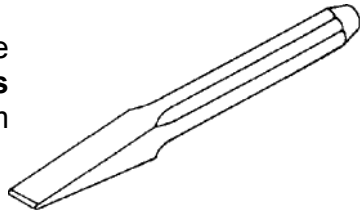

The diagram below shows a cold chisel being used to chop out a rectangular shaped hole. The area for the hole has had small holes drilled all the way around the inside of the line (**chain drilling**). The chisel is hit with a hammer to cut between the holes until the inside is cut free. The edges are then filed with a safe-edge file.

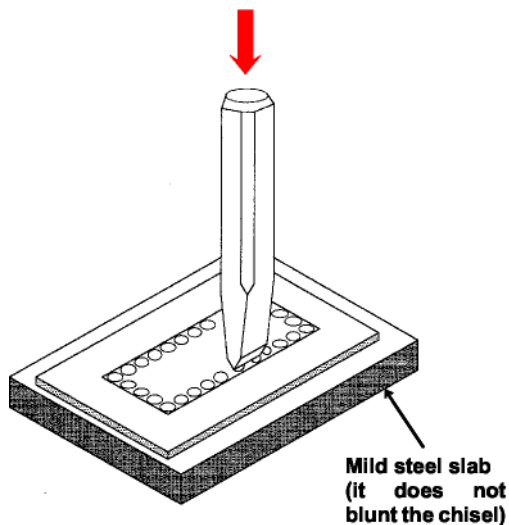

A cold chisel can also be used to trim the edge of sheet metal. This leaves a new edge that needs minimal filing. The metal is placed in the vice so that the line to be cut to is level with the top of the vice jaws. The chisel is then rested on the top of the vice jaws and hit with a hammer.

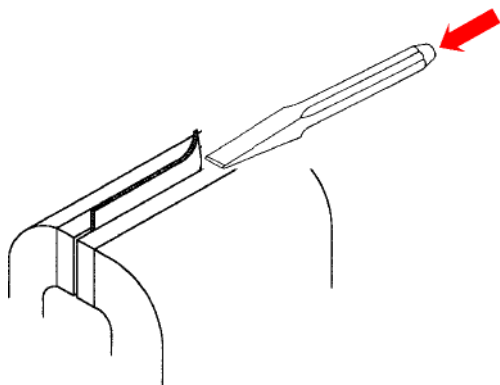

## TINSNIPS

Tinsnips work like scissors and use a shearing action to cut thin sheet metal.

### Straight Snips

Used for cutting along straight lines.

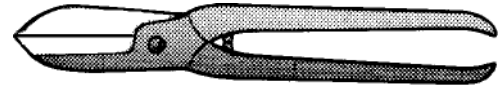

### Curved Snips

The blades are curved to allow the snips to cut along curved lines.

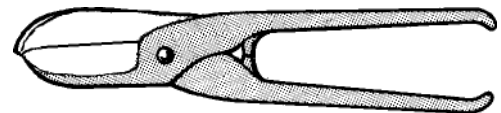

### Universal Snips

The blades are designed to allow the snips to cut along both straight and curved lines.



When tinsnips are used the waste metal bends into a curved shape.

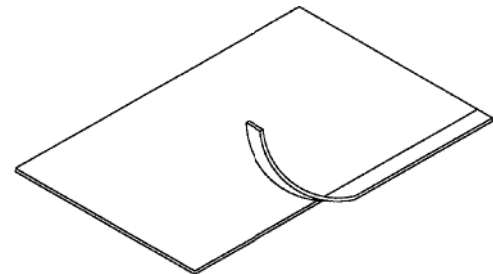

1. What are cold chisels made from?
  2. Illustrate the term chain drilling.
  3. How can a cold chisel help make a rectangular hole in a piece of sheet metal?
  4. What is the advantage of using a cold chisel to trim the edge of a piece of sheet mild steel?
  5. When would you choose to use a curved blade pair of tinsnips?
  6. What is the disadvantage of using tinsnips to cut between two shapes that you want to keep?
  7. What does the name 'universal' mean when applied to a pair of tinsnips?
- A. Research what is meant by shearing action and illustrate your findings.

**KEY WORDS** Cold chisel: Chain drilling:  
Tinsnips:

**LATHEWORK**

A metalwork lathe is a machine used for a number of **turning** processes.

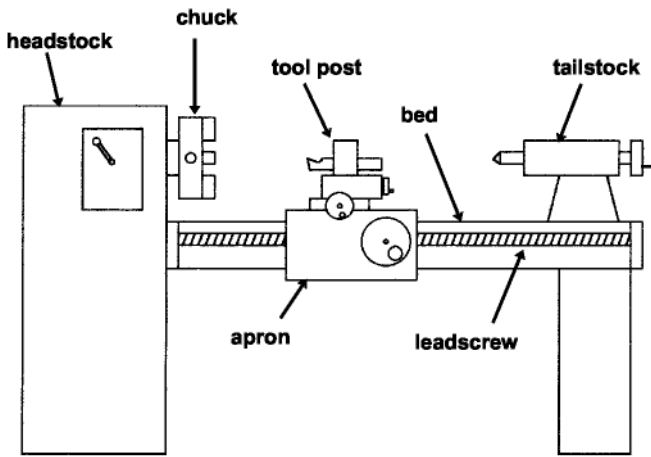

The cutting is done by a **single point cutting tool**. The tool is made from HSS or from tool steel with a hard wearing, tungsten carbide tip.

**HSS tool**

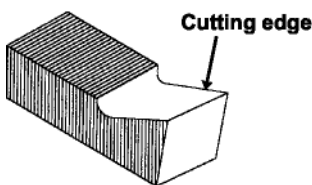

**Tungsten tipped tool**

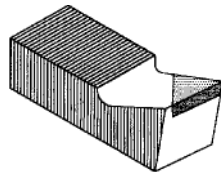

**Processes**

A lathe is a very accurate piece of machinery and all turning processes can be carried out to an accuracy of **one 100th of a millimetre**.

**Turning down**

This reduces the diameter of a rod.

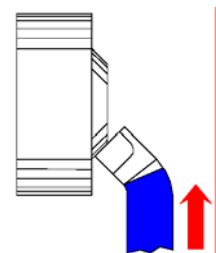
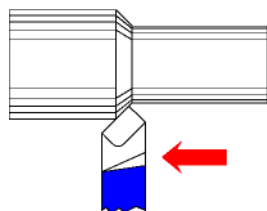

**Facing off**

This shortens the length of a rod and provides a smooth flat end at right angles to the side.

**Parting off**

This is a way of cutting off a length of the rod. The diagram shows the parting process half finished.

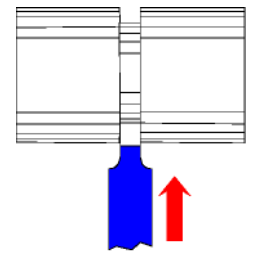

**Thread cutting**

By using a correctly shaped tool, screw threads can be cut.

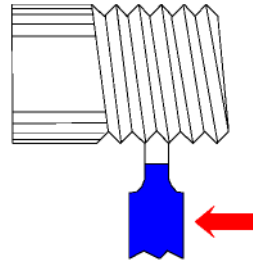

**Boring**

Boring is enlarging a hole by cutting away the inside wall.

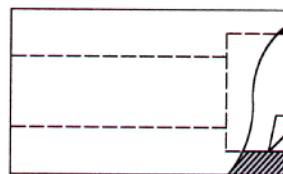

**Drilling**

Holes drilled into the ends of rods are perfectly centred and run along the axis of the rod.

**Note:** The chuck revolves the work, while the drill bit is held still in the tailstock.

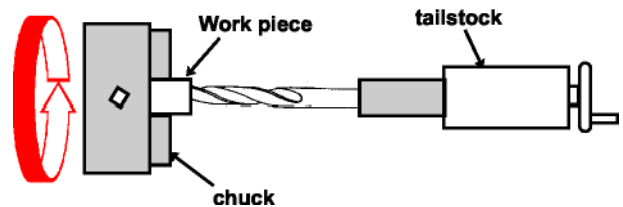

**Centre drill**

The centre drill is used for starting a hole. It provides a short pilot hole for the main drill bit.

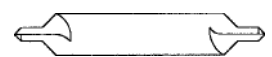

**KEY WORDS** Facing off: Parting off: Boring: Centre drill:

1. Draw a labelled view of a metalworking lathe.
2. What materials are cutting tools made from?
3. How accurately can a lathe work?
4. Illustrate **four** turning processes.
5. Describe the process of boring.
6. What are the differences between drilling using a pillar drill and drilling using a lathe?
7. How do you start the process of drilling a hole, when working with a lathe?

## FORMING METAL – BEATING

Beating is probably the oldest method of shaping metals and relies upon metal's malleability (being squashed and bent without splitting and cracking).

## HOLLOWING

Hollowing is a procedure used to produce shallow bowl shapes from circular sheet metal blanks.

1. A circular blank of metal (copper or brass etc.) is prepared by **annealing** it to make it more malleable.



### Annealing

Annealing is carried out by heating the metal to a dull red. The metal is now more malleable, so it will not split when it is hit with the mallet.

The surface will now be black (burnt tarnish) and this needs to be cleaned off before hollowing. Either emery cloth can be used to clean it, or the still warm disc can be placed into a bath of dilute sulphuric acid.

**Note:** If the metal is aluminium, it cannot be heated to red heat because it never glows red. Soap should be rubbed onto the surface, and the metal heated gently until the soap turns a dark brown, the correct temperature has now been reached for annealing. The burnt soap can be washed off with water.

To form the hollow shape, either a hollowed hardwood block, or a leather sandbag can be used.

Forming block

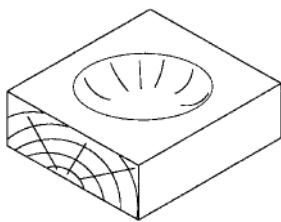

Sandbag



2. The metal disc is placed at a shallow angle as shown and is hit with an egg shaped **Bossing Mallet**.

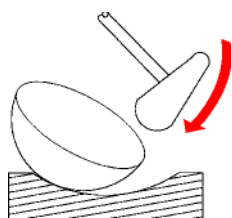
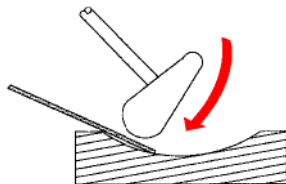

3. After each blow the disc should be rotated one space, so the next blow lands beside the first. Starting from the outer edge, spiral into the centre. The bowl shape will form automatically.

## SINKING

Sinking is a procedure that can produce a shallow bowl with a lip around the top edge and a flat base.

The metal disc, shown in the diagram in transparent form, is placed against both dowel pegs. The edge on the top surface of the **sinking block** remains horizontal

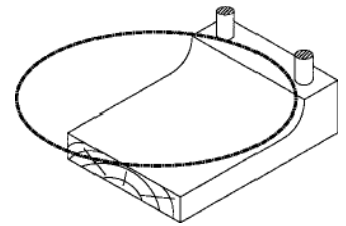

and produces the lip.

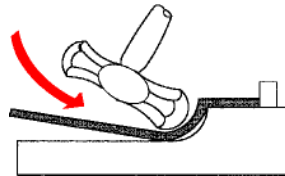

A **blocking hammer** is then used to create the hollow shape.

## PLANISHING

Planishing is a procedure that is carried out after hollowing or sinking, it is used:

- to remove any unwanted bumps and to correct the overall shape.
- to harden the metal and make it more rigid.

A cut away view of a **Planishing Hammer** being used. The bowl is placed over a **Mushroom Stake**. Starting in the centre, the bowl is revolved one space after each blow. The blows should spiral outwards to the edge.

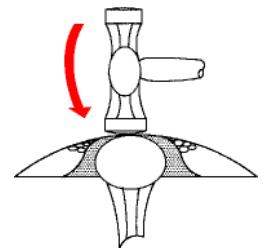

The surface becomes covered in little indents that can be left to give a textured finish, or removed, by smoothing the surface with an abrasive stone.

**KEY WORDS** Hollowing: Bossing Mallet:  
Sinking: Planishing:

- Describe how metal should be prepared for hollowing.
- What tools can be used to form a bowl shape?
- Illustrate the hollowing procedure.
- What is the difference between hollowing and sinking?
- Sketch a product made by hollowing and a product made by sinking.
- Why should a hollowed product be planished?
- Give an illustrated description of the planishing process.



## FORMING METAL – BENDING

Thin sheet metal (up to 1.5mm thick) can be bent, by hand, into boxes, trays and cylinders. The metal sheet needs to be prepared as a 'net' or 'development' before bending.

**Note:** It is a good idea to make a full size card model first, so that costly metal is not wasted if there is an error.

## A typical net for a metal box

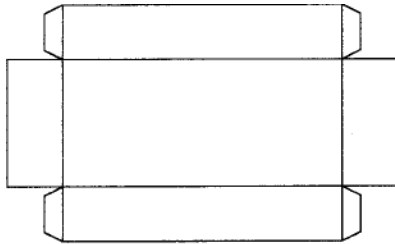

To make the edges more rigid and to make them less sharp, they can be folded to make a 'safe edge'.



Hit with mallet and wooden striker

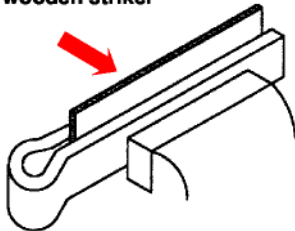

To bend an edge to 90° on a sheet of metal that is larger than the jaws of the vice, **folding bars** can be used to hold the sheet.

To enable both sides and ends of a box or tray to be folded, a wooden block can be cut to be the same size as the base.

**Note:** The wood has to be thicker than the height of the sides.

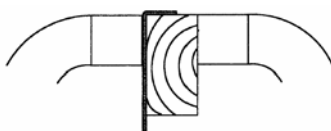
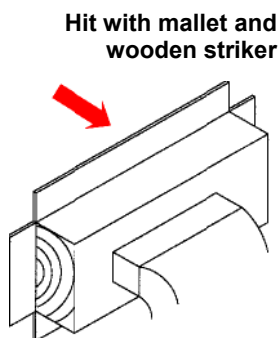

One edge bent to 90°

If the side is hit directly with a mallet it tends to end up with a wavy edge. It is better to hold a hardwood striker at a slight angle against the side and hit the striker with the mallet.

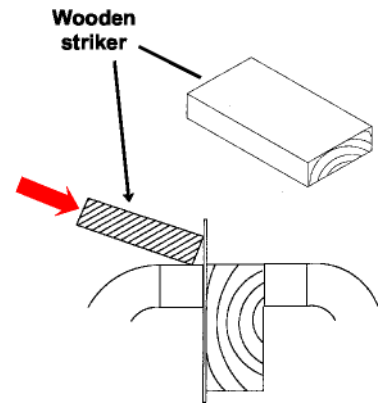

## Forming a Cylinder

For bending curves, a machine that has three adjustable rollers is used. The tightness of the curve can be controlled by altering the position of each roller.

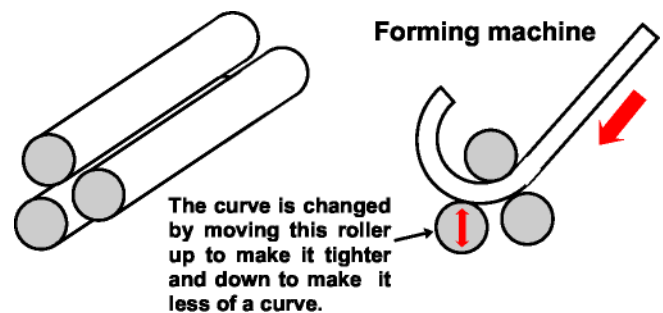

**KEY WORDS** Net: Folding Bars: Forming Machine:

1. What thickness of sheet metal can be bent by hand?
  2. Draw a net of a tray made from sheet brass. The tray is to be 200mm long, 150mm wide, with 20mm high sides, when finished.
  3. Why should a card model of the 'net' be made?
  4. How can the edges of the tray be made safer?
  5. What advantages are there in using folding bars for bending the edge of a sheet of metal, instead of vice jaws?
  6. How can both the sides and ends of a box or tray be folded up?
  7. How can you avoid the edge of the sides becoming wavy?
  8. Illustrate how a cylinder could be made from a sheet of copper.
- A** Make a paper or card model of a net that would be suitable for making a copper container for a house plant in a 100mm diameter flowerpot, that is 95mm tall.



**FORGING**

Hand forging is one of the oldest methods of shaping metal and is associated with the work of a blacksmith. Today there are many computer controlled processes.

One reason for forging metal is to improve its strength. When it is hit it is squashed and becomes more dense. Also, a shaped product will have the 'grain' (layers of crystals) flow around the shape.

A machine cut shape with sharp internal corners

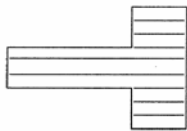

Straight grain lines that can be the source of a crack at the internal corner

A forged shape with curved (filleted) corners

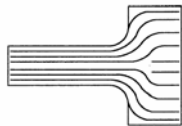

Grain lines are closer together and follow the corner shape, giving extra strength.

The heated metal is shaped on an **anvil** by hitting it with a heavy hammer.

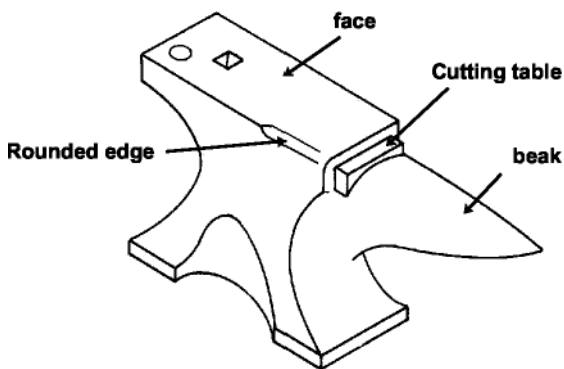

**Holding the metal**

Tongs are used to hold the metal being forged, they come in large variety of styles and sizes, to hold different shapes of metal bar.

**Open-mouth tongs**

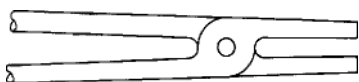

For gripping thick flat material

**Pickup tongs**

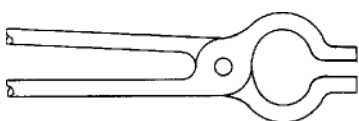

For gripping awkward shapes including round bars.

**Note:** It is important that the correct tongs are used to grip the hot metal firmly.

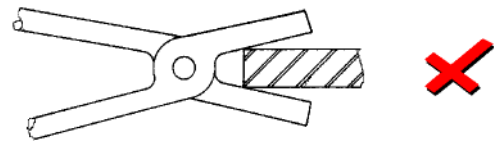

**Bending**

Bending a bar on the anvil, using the rounded edge of the face.

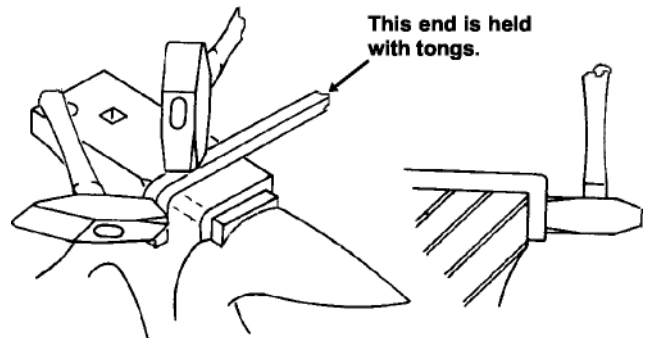

**Drawing Down**

To make a round bar pointed it has to be **drawn down**. Drawing down requires four stages to avoid the tip splitting.

1. Hold the bar at a slight angle to the anvil face and hit on one side, the anvil face flattens the other side at the same time.
2. Turn the bar 90° and hit again to make the point square in shape.

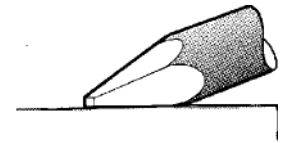
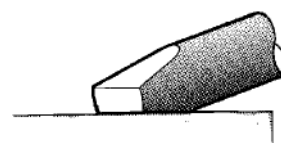

3. Hit each corner of the square shape to turn it into an octagonal shape
4. Continue turning the bar and hitting the corners until the point is round in shape.

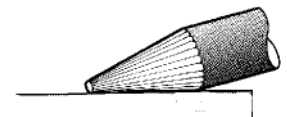
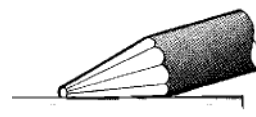

**Upsetting**

Upsetting is the term given to the process of thickening the metal. This is useful for maintaining strength when drilling a hole.

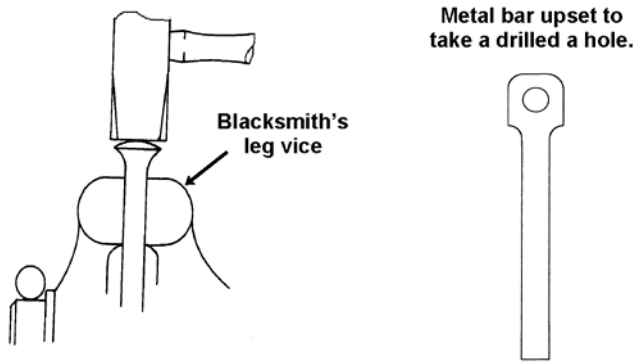

**Twisting**

Heat the bar to a bright red and then grip it in the vice and slide on a special twisting tool, or use a large tap wrench. Twist the metal while it is still red hot. Twisting will only occur between the vice and the wrench.

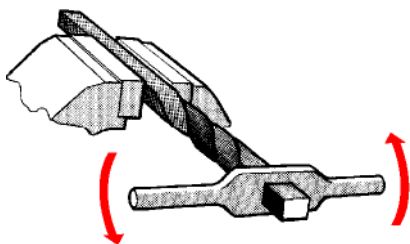

**Forging a Loop**

A loop is useful for the end of a handle to improve grip and to allow the object to be hung up.

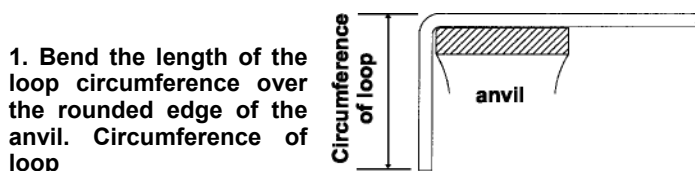

1. Bend the length of the loop circumference over the rounded edge of the anvil. Circumference of loop

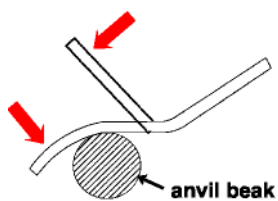

2. Start the curve by hammering it over the anvil beak.

3. Work towards the end of the metal to complete the curving.

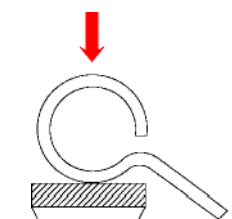
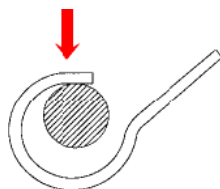

4. Close the loop by tapping it with a hammer on top of the anvil face.

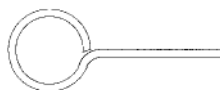

**Scrolling**

Creating scrolls from strips of wrought iron has been a traditional form of decoration for gates and screens. Today, the scrolls are made of mild steel and are still popular.

**An 'S' scroll**

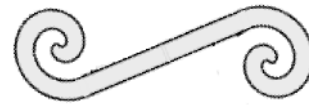

To make identical scrolls a **master scroll** is used. The metal is heated to bright red in a forge and then tightly wrapped around the master scroll. To stop the metal from slipping the end is prepared by forging the end into a hook shape.



Forming the scroll by wrapping the hot metal around the master scroll.

Plan view of master scroll hook

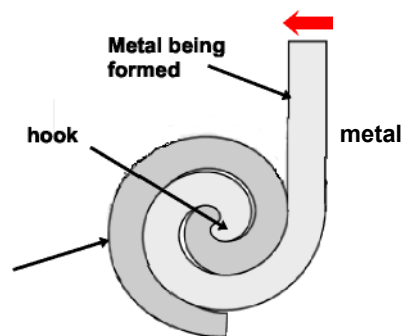

front view of master scroll (shown without the piece of metal being formed)

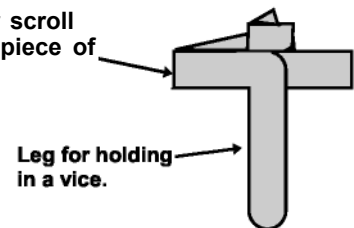

**KEY WORDS Anvil: Tongs: Drawing Down: Upsetting: Scrolling:**

1. Explain how forging a component can make it stronger than sawing and filing it to shape.
2. Draw a blacksmith's anvil and label its parts.
3. Why is it very important that the correct size tongs are used when forging?
4. Show how the anvil can be used to bend the end of a bar of mild steel.
5. Illustrate how a point can be forged on a piece of round bar so that it does not split.
6. Explain the process of upsetting and why it is done.
7. When twisting a bar, how can you make sure that the twisting is exactly where you want it?
8. Illustrate the stages used for forging a loop.
9. Give an example of what is meant by a metal scroll.
10. How do you prepare a bar for scrolling on a master scroll?

**CASTING IN METAL**

Casting is a method of shaping metal into simple or complicated shapes without producing any waste. Removed metal can be re-melted and used again.

**Sand Casting**

The oldest form of casting involves pouring molten metal into a shaped hole made in damp sand and letting it cool. This is the form of casting that can be done in school using low melting point metals, such as the aluminium alloy (LM4).

**Stages in Sand Casting**

**1. Making the Pattern** The pattern is the shape to be cast, made in **wood**. It is this that is used to make the correct shape of hole in the sand. The pattern should be tapered so that it can be taken out of the sand without dislodging any sand grains. The taper is known as the **Draft**.

Pattern without draft being removed. It dislodges grains of sand into the mould as it rubs the sides.

Pattern with draft being removed without touching the sides. The mould remains clear.

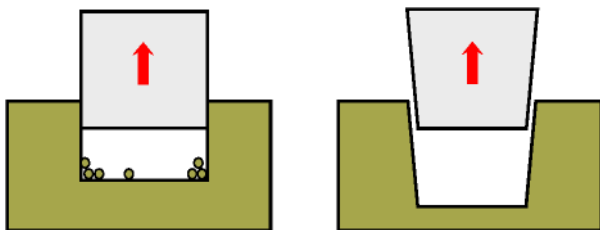

Internal corners need to have a **fillet** to stop cracks appearing during cooling.

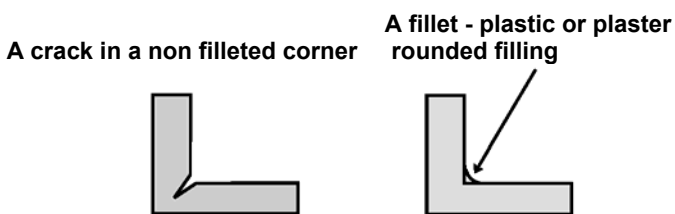

A pattern that because of its shape would dislodge sand when it was removed needs to be split into two or more sections.

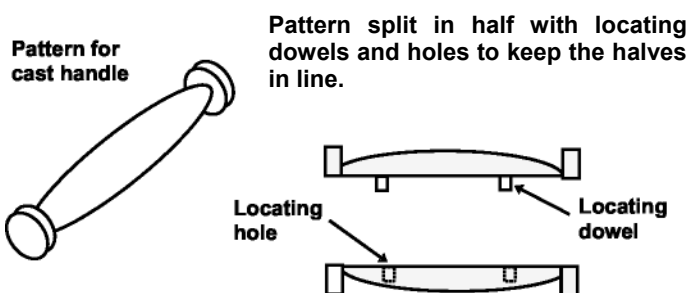

**2. Moulding** Moulding is the process of creating the hollow shape in sand.

The diagram shows the moulding box. It is in two halves; the top is called the **cope** and the bottom the **drag**. Neither has a base. They are located together by a pin and hole system at each end. On the inside of the sides is a recess to help hold the sand in place.

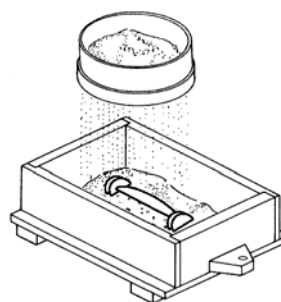
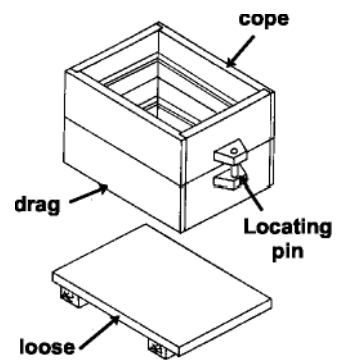

**A)** The drag is turned upside down and put on the base board. The pattern is placed in the middle. Moulding sand, made damp with oil or water, is sieved over the pattern until the pattern is covered.

**B)** The rest of the sand is shovelled in and then rammed with a rammer until it is packed tightly. The surface is then levelled by scraping a metal strip across (strickling).

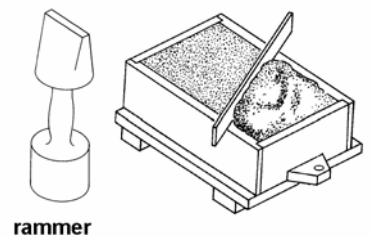

**C)** The drag is turned the right way up and the cope is then placed on top. The top half of the pattern is added and also the sprue pins are positioned. Sand is then added and rammed to fill the cope.

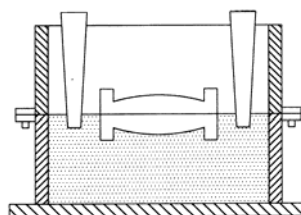

A **sprue pin** is a cone shape, made from wood that is used to create holes in the sand that will allow the molten metal to be poured into the mould and the excess metal to rise to the top. The holes are called **sprues**.



**D)** The cope is now lifted off and the top half of the pattern and the sprue pins are removed.

Channels called **gates** are cut between the sprue pin holes and the pattern to allow the molten metal to flow into the mould cavity.

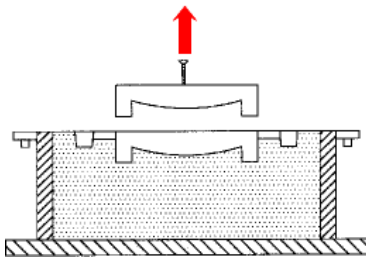
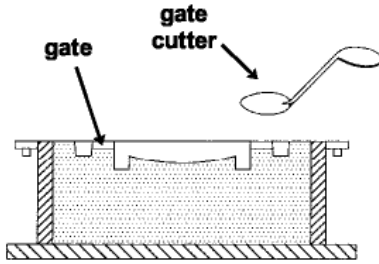

**E)** A wood screw is screwed into the pattern and it is tapped from side to side to release the pattern from the sides of the sand mould. The pattern is then carefully lifted vertically from the mould.

**F)** The cope is placed back on the drag. A hollow basin shape (pouring basin) is cut into the sprue hole that the metal will flow into (runner). A thin metal rod is pushed into the sand to create narrow holes that will allow air to escape when the metal is poured.

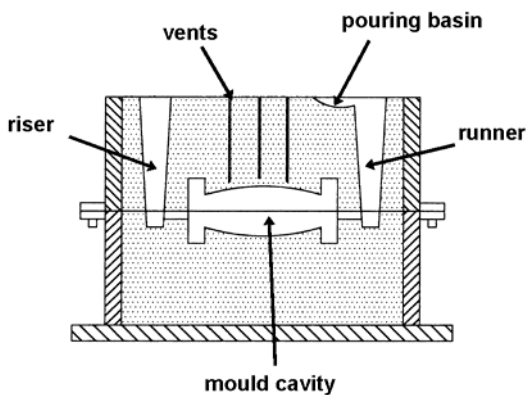

**3. Pouring** The mould is now ready for pouring. **This must be carried out by a teacher.** Molten metal is slowly poured into the pouring basin, the basin will overflow into the runner. The metal will then flow into the mould. Trapped air can escape up the riser or through the sand above the pattern into the vent holes. The metal should be poured until it fills the riser.

When the metal is cooled and solidified the mould can be broken open. The casting will come free with its gates and sprues attached, these will have to be removed by sawing them off and filing down the stumps. The sprues can be remelted.

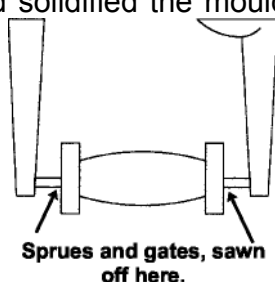

**Cores**

If the handle needs a hole through it so that it can swivel or slide on a bar, it can be cast with the hole in place. To have a hole in a casting a **core** needs to be used.

For a split pattern, the core needs to split as well. The core is a cylindrical shape made from sand mixed with a binder and baked in the core box. This makes it rigid so it will not break under its own weight.

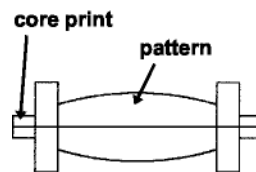
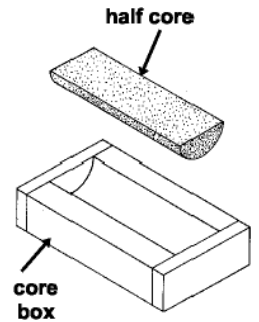

The pattern needs to be altered to include extensions called core prints. These leave a depression in the sand to hold the core in place.

The core is placed in the core prints in the mould cavity. The molten metal will flow around the core.

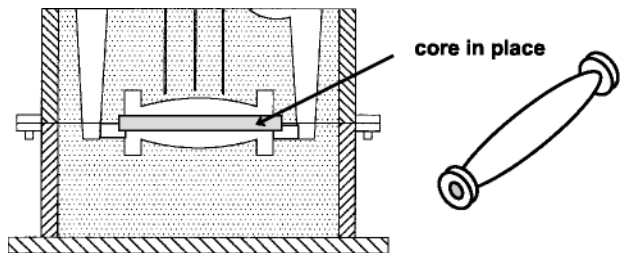

When the casting has cooled, the core is rammed out of it with a steel rod. This leaves a hole through the centre.

**KEY WORDS** Pattern: Mould: Draft: Fillet: Sprue: Gate:

1. Explain why 'draft' is required on the sides of a pattern.
  2. What is a 'fillet' in casting and why should it be used?
  3. Why are some patterns split and how are the two halves held in place?
  4. Why is the moulding box made in two halves?
  5. Explain the mould making process using notes and diagrams.
  6. What is the purpose of the vents in a mould?
  7. What has to be done to the casting after its removal from the mould before it can be used?
  8. What is a core used for when casting?
  9. How does the pattern have to be altered if a core is required?
  10. How is a core held in place in the mould cavity?
- A** Name **five** items or parts, that can be found at home or on a car or cycle, that would be made by casting.

**METAL FABRICATION – MECHANICAL**

**Machine Screws**

Machine screws have a parallel thread and need a threaded hole to screw into. They come in a wide variety of materials and sizes and are used for semi-permanent joining.

Instead of drawing a complicated thread each time, a simple schematic drawing can be used.

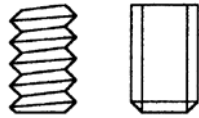

Schematic drawing of a thread  
cheese head  
countersunk head  
pan head

**Common machine screws**

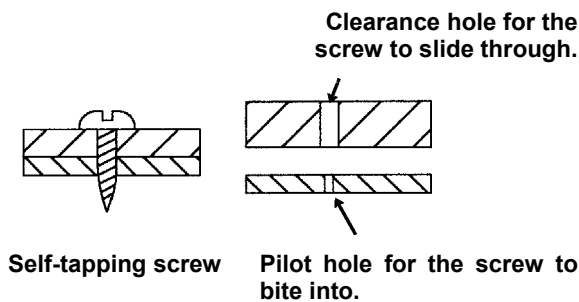
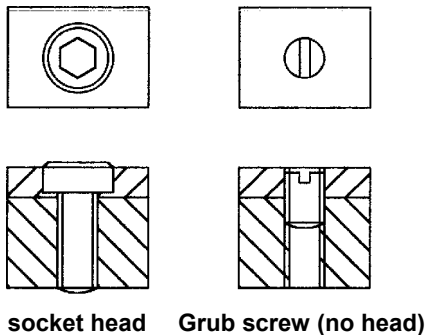
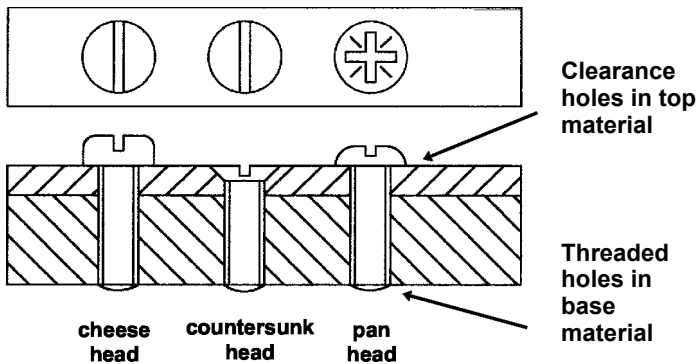

The self-tapping screw is used on thin sheet metal. It cuts its own thread into the pilot hole. This can speed up the manufacturing process, cheaply.

**Nut and bolt**

A strong method of holding two parts together



Washers are used to spread the load over a slightly larger area and to prevent damage to the material as the nut is tightened.



Some washers are used to prevent vibration from loosening the nut.

**Spring washer**



**Serrated washers**

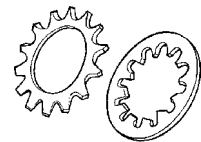

**Rivets**

Rivets are a quick and easy method of permanently joining materials. However, they can be drilled out if the materials need to be separated later.



Rivets are made from iron, aluminium and brass and come in many lengths and diameters.

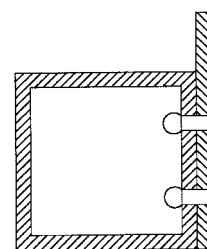
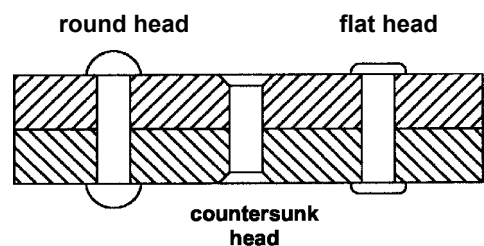

Pop rivets are used when it is impossible to get to both sides of the joint.

Pop rivets holding a sheet of metal to square tubing.



**METAL FABRICATION – THREADING**

When the size of the thread has been decided the hole has to be drilled to the correct **tapping size**. This is a hole that is smaller in diameter than the thread diameter (nominal size), so that the thread can be cut into its side. There are printed tables to tell you which size drill bit to use.

Metal can be held together by screws screwed into threaded holes, and also threaded rod can be screwed into a threaded hole. Cutting an internal thread into the side of a hole is known as **Tapping** the hole, because the tools used to cut the thread are called **Taps**. Cutting an external thread on the outside of a length of rod is known as **Threading** and the tool used to cut the thread is known as a **Die**.

Before a hole can be threaded, the size of the thread must be decided. In school, threads from 2mm diameter to 12mm diameter in 1mm jumps can be cut. A tap and die have the size stamped on them, e.g. M8 x 1.25. The 'M' stands for Metric. The 1.25 is the distance in millimetres, between the tip of each thread tooth, this is called the **Pitch**.

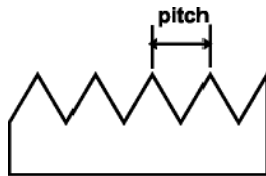

Taps are normally sold in sets of three. If a **blind hole** (a hole that does not go all the way through a piece of material) is to be tapped all three taps are used in turn, starting with the taper tap. The taper allows the tap to start with its tip firmly in the hole and the thread to be cut gradually deeper into the side, with each turn.

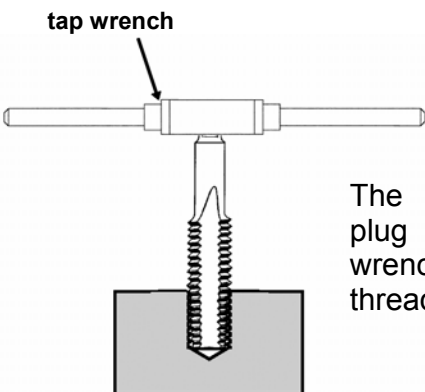
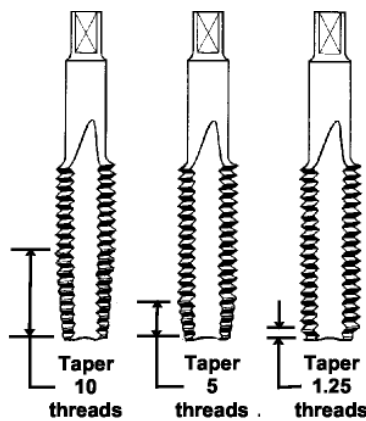

The diagram shows a plug tap, held in a tap wrench, completing the threading of a blind hole.

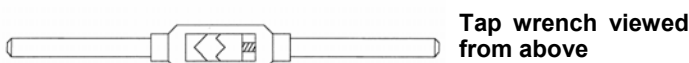

An external thread on a metal rod is cut by using a **die** held in a **die stock**. The die is adjustable so that threads that are slightly smaller or larger than the nominal size can be cut. This allows for a loose or tight fit between the external and internal threads.



**Adjustable split die**

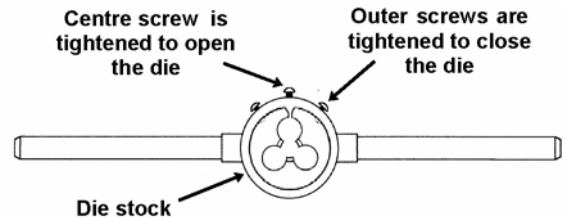

It is a good idea to cut the thread with the die split open as far as possible and then test the fitting of the external and internal threads. If the threads are too tight then close the die a little, re-cut and test again. Repeat the process until the thread runs smoothly.

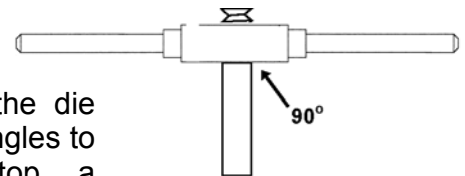

Make sure that the die stock is at right angles to the rod to stop a 'drunken' thread being cut.

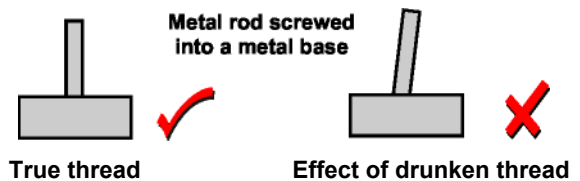

**KEY WORDS** Tap: Die: Blind hole: Tap wrench: Tapping size: Die stock: Drunken thread:

1. What does the term 'tapping a hole' mean?
2. Where would you find M10x1.5 printed and what does each part stand for?
3. How can you measure the 'pitch' of a thread?
4. What is a 'tapping size' hole?
5. Illustrate a 'blind' hole.
6. What are the three taps that make up a set? How can you tell the difference between them?
7. Make a neat sketch of a Tap Wrench.
8. What is used to cut an external thread?
9. Explain the use of the three screws found on the Die Stock.
10. With the help of diagrams explain the effect of a drunken thread. How can this be avoided?

**METAL FABRICATION – RIVETING**

The tools required for riveting with solid rivets are:

**Rivet Set & Snap**

The hole in this tool is used to set up the joint by making sure that the pieces of metal and the head of the rivet are pressed firmly together. The hollow is used to form the shank of the rivet into a second 'head'.

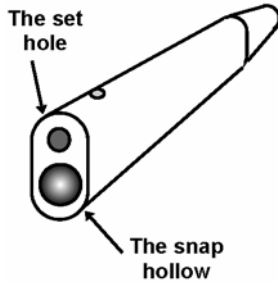

**The peen**



**Ball-peen Hammer**

**Ball-peen hammer**

The peen (also spelt 'pein') is used to roughly form the second head of the rivet.

**Stage 1**

Place the rivet in the joint and mark a line 1½ times the diameter of the shank from the metal to be joined. Remove the rivet and cut the shank to the line.

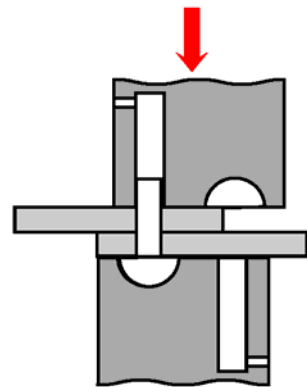
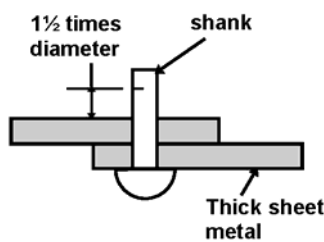

**Stage 2**

Use two 'Set & Snaps'. Hold the lower one in the vice and tap the upper one with the normal face of the hammer. Make sure that there are no gaps in the joint.

**Stage 3**

Hammer the rivet shank into a rough mushroom shape using the Ball Peen part of the hammer head.

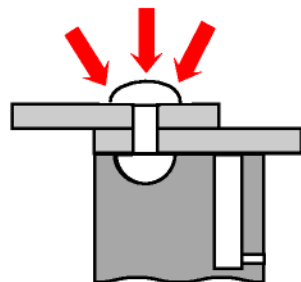

**Stage 4**

Use the snap part of the upper snap & set to smooth and shape the second head by hitting it with the hammer. The rivet is now complete.

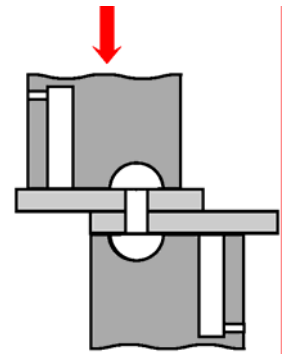

**Countersink Riveting**

Stage 1 and 2 are the same as for a round head rivet, except the head of the countersunk rivet should be placed on a solid flat surface. The shank is hammered by the peen until it fills the countersunk hole.

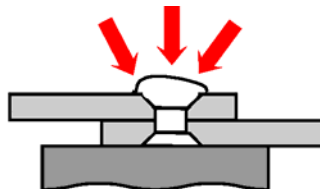

The rough mushroom shape is then filed until the head is flat and flush with the surface of the metal sheet.

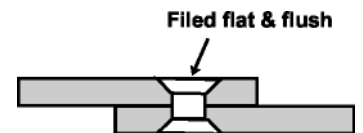

**Lining up rivet holes**

When more than one rivet is used it is important that all the holes in one metal sheet line up with the holes in the sheet to be joined to it.

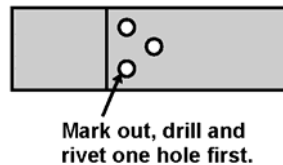

To make sure the holes line up, mark out and drill one pair of holes only. Rivet them together and then line up the metal sheets. The remaining holes can then be marked out and drilled.

**Pop Riveting**

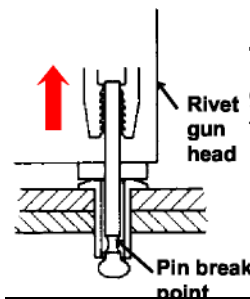

The pin is pulled by jaws in the gun. The pin head squeezes into the tube of the rivet. The pin then breaks away and leaves the head behind.



1. Illustrate how the ball peen of a hammer may be used, when riveting.
2. What is the purpose of the Rivet Set & Snap?
3. How can you make sure that all the holes line up when using more than one rivet to make a joint?
4. How is the second head formed on a pop rivet?

**KEY WORDS Set: Snap: Ball Peen: Pop rivet**

## SOFT SOLDERING

Soft soldering is a permanent method of joining most metals such as steel, tinsplate, copper and brass.

**Note:** Aluminium cannot be soft soldered.

**Solder** is an alloy of **Lead** and **Tin**. The amounts of lead and tin vary, depending on the melting point and flow rate that is required e.g.

Purpose	Alloy	Melting Point	Hardness
Electrical work	More tin than lead	183°C	Soft and slightly flexible
Plumbing (e.g. Joining copper pipes)	More lead than tin	Up to 250°C	Hard and rigid

### Electrical soldering

Soft solder in wire form is used with an electric soldering iron to solder components to an electric wire or to a Printed Circuit Board (PCB)

1. Check that the parts to be joined together and the soldering iron tip are clean. (use emery cloth to clean them)
2. Hold the parts to be joined together in place.
3. Attach a heat sink (a device placed between the joint and the component that will soak up the heat and stop the component from getting too hot) e.g. a crocodile clip.
4. Check that the soldering iron is hot enough by melting a little solder onto the tip.
5. Hold the hot tip of the soldering iron against the joint for approximately 3 seconds, to preheat the joint.
6. Touch both the joint and the tip of the soldering iron with the solder wire, then remove it and the soldering iron the moment the end of the wire melts. (approximately 1 second).
7. Wait until the surface of the joint sets and goes dull before you remove the heat sink.

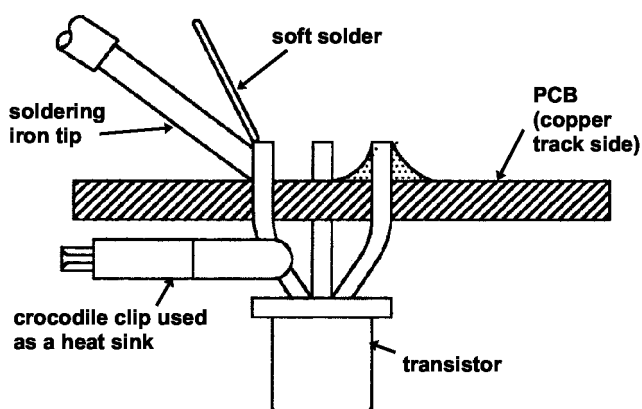

### Sheet metal soldering

To make a strong joint between sheets of metal a **Flux** must be applied before soldering.

#### Flux

A flux is a chemical that does two essential jobs to help create a strong joint.

1. When the metal is heated up for soldering it stops an oxide layer forming (tarnish). Molten solder must be able to soak into the surfaces of the metal sheets being joined, to make a strong joint.
2. It breaks down the surface tension of the molten solder to allow it to flow in between the metal sheets.

There are two types of flux for soft soldering:

**Acid** - a clear liquid that when applied will clean the surface of the sheet metal by dissolving any oxide layer or grease, before soldering starts. This flux must be washed away with water as soon as the joint has been soldered, otherwise it will weaken the joint.

**Passive** - a brown resin that looks like grease. This does not dissolve any old oxide layers, so surfaces need to be cleaned with emery cloth first. It does not need to be washed away at the end.

1. Apply flux to both surfaces
2. Melt solder onto the hot tip (tinning the iron)

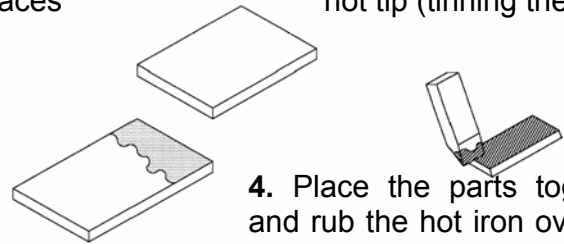

3. Apply solder to both fluxed surfaces

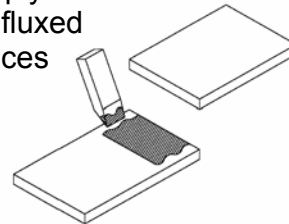

4. Place the parts together and rub the hot iron over the joint to re-melt the solder. Then let it cool and set.

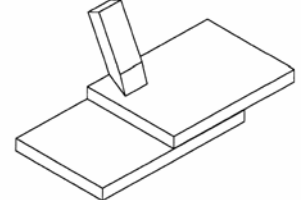

### KEY WORDS Heat sink: PCB: Flux:

1. Which metals is soft solder made from?
2. What is the melting point range of soft solder?
3. Why must the parts being soldered be clean?
4. Why do you need to use a heat sink when soldering electrical components and how does it work?
5. Why do you need to wait until the surface of the joint goes dull before moving it?
6. What are the two main reasons for using a flux?
7. Explain the difference between the two types of flux.
8. Illustrate the stages of soldering two sheets of metal together.
- A. Create an illustrated instruction sheet for soft soldering a resistor onto a PCB.

**HARD SOLDERING**

Hard soldering is a similar technique to soft soldering except that far higher temperatures are used and far stronger joints are made.

**Brazing**

The 'solder', called **spelter**, is brass, (copper and zinc). It melts at 870°C.

The heat is supplied by a **gas blowtorch** attached to a **brazing hearth**, or by an oxyacetylene torch (see welding).

Brazing is normally used for joining steel together.

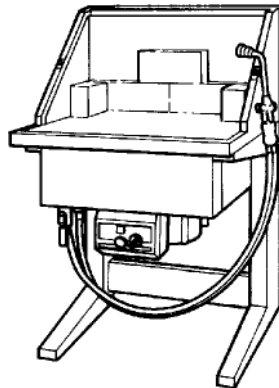

**Brazing Hearth**

Joints need to be held together with wire or interlocked because the flame is powerful and can move loose sections of steel.

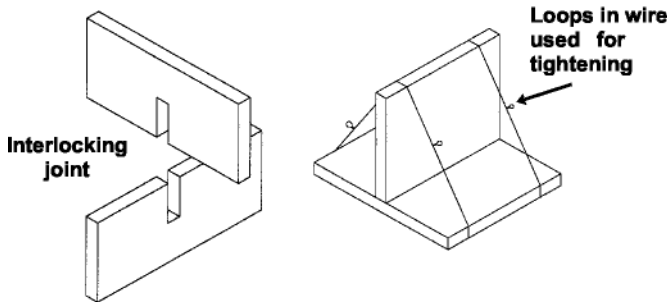

**Brazing Flux**

For brazing, the flux is a powder made from the salt **Borax**. It needs to be mixed with water to form a paste so that it is not blown away by the flame.

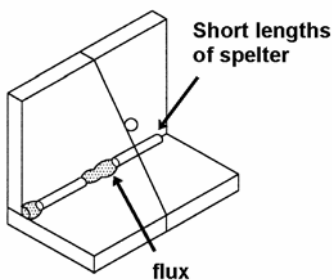

The flux, in paste form, should be spread over the joint.

Short lengths of spelter can be cut and laid along the joint at intervals, on top of the flux.

Place the joint on the brazing hearth surrounded by fire bricks. The bricks are important because they reflect the heat and flame so that the joint can get to a high enough temperature to melt the spelter.

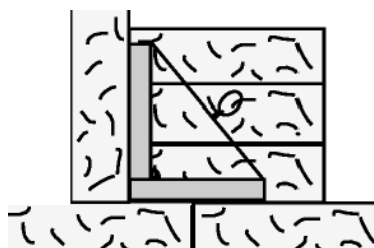

**Silver soldering**

Silver solder is an alloy of copper, zinc and silver. The melting point is lower than spelter and ranges from 625°C to 800°C. The lowest melting point solder has the most silver added. Silver solder is used for joining brass, copper, nickel and pure silver. There are three grades of silver solder:

**Easy flow** - melts between 625°C and 690°C

**Medium** - melts between 690°C and 725°C

**Hard** - melts between 725°C and 800°C

The grade system is useful when a number of joints are close together and cannot be soldered in one go.

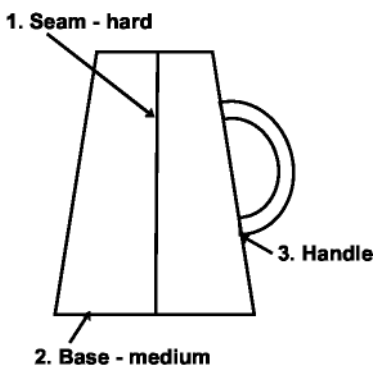

**Tankard**  
(made from nickel-silver)

If one type of solder only was used, then the solder put on the seam would re-melt and the joint would spring open when the base was being heated for joining. When the three grades are used, as shown in the diagram, each joint melts at a lower temperature than the last, so earlier joints stay set.

**Flux** used for silver soldering is also called **Easy-Flow**. It works at a lower temperature than brazing flux

The diagram shows a typical set-up for silver soldering a seam. Small pieces of solder are laid at regular intervals on the fluxed joint.

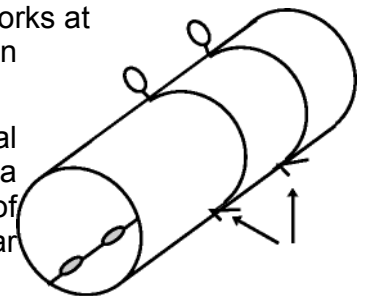

Wires to stop the cylinder from opening up when heated

**KEY WORDS Spelter: Brazing: Easy flow:**

1. What is 'spelter' and what is it used for?
2. Why do joints need to be held in place for hard soldering?
3. Why do the wires used for holding joints together have a loop put in them?
4. What type of flux is used when brazing and in what form is it applied?
5. Make an annotated sketch of the set-up of a joint ready for brazing on the brazing hearth.
6. What are the constituents of silver solder?
7. What are the three grades of silver solder and what are their melting point ranges?
8. Illustrate how the three grades of silver solder are used and explain why they are necessary.

**WELDING METAL**

Welding is a permanent method of joining two pieces of the same metal together by melting them both and letting them fuse together as they cool down and become solid again.

Welding is normally used for steel and aluminium. There are three main types of welding:

- Gas** - using an oxyacetylene gas flame
- Arc** - using an electric spark
- Resistance** - using an electric current.

**Gas Welding**

This is the most common form of welding used in schools. Heat is supplied by an oxyacetylene torch that burns acetylene gas mixed with pure oxygen, to a temperature of 3,500°C.

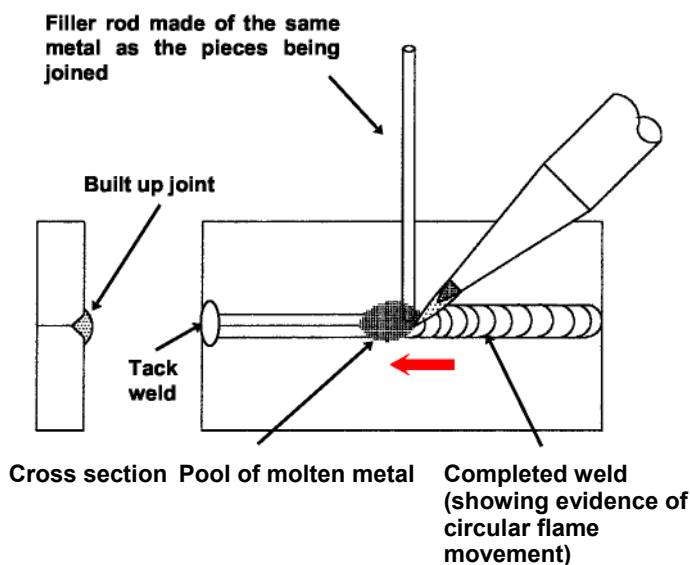

The filler rod is used to build up the joint and to replace the metal that has evaporated. The flame is moved forward in a series of small circular movements to heat a wider area than the diameter of the flame.

**Flux** is not normally used for welding steel, but is essential in large quantities, when welding aluminium.

Before welding along a joint, both ends need a small weld to hold the ends together. This is called a **tack weld**.

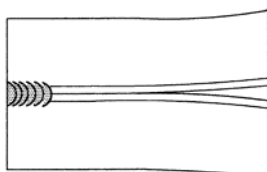
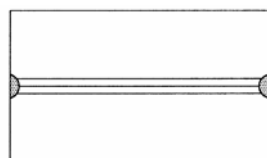

If the ends are not tacked the pieces will warp in the heat and the joint will separate.

**Arc Welding**

The joint metal and the filler rod are both connected to an electric circuit. When the rod is held a short distance away from the joint, sparks fly between the two. The temperature of the sparks is so high that both the end of the rod and the joint metal melt and form a weld pool.

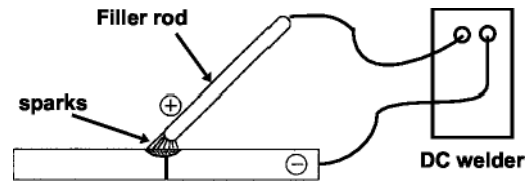

**Resistance Welding**

Also known as '**spot welding**', this is suitable for thin sheet steel. It relies upon passing a current through the sheets of metal and heating them up where they touch each other, because this is where there is most resistance. (Electrical resistance produces heat).

Two electrodes squeeze the sheets together and then pass an electric current through for approximately 2 seconds, then hold until the weld sets (2 or 3 seconds).

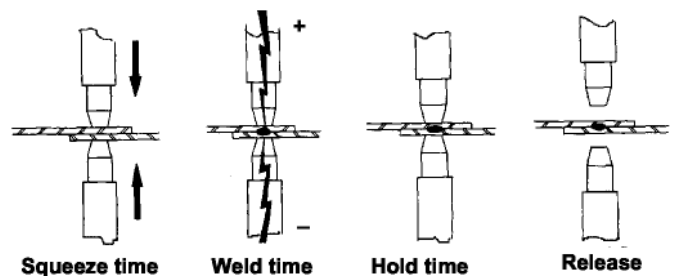

Resistance welding does not produce a continuous weld. The result is like a line of tack welds 30 to 40 mm apart.

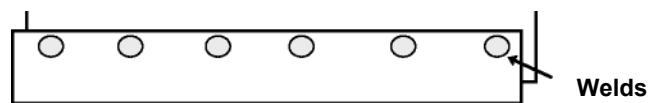

**KEY WORDS** Oxyacetylene: Tack welding: Arc: Resistance:

1. What are the three main types of welding?
2. Which gases are burnt to produce a welding flame and at what temperature do they burn at?
3. Why is filler rod used?
4. The flame is moved in a series of small circles, why is this?
5. Illustrate why a joint should be tack welded at both ends first.
6. Explain, with illustration, how arc welding works.
7. What provides the heat when spot welding?
8. Illustrate the spot welding cycle and the resulting joint.



**HEAT TREATMENT**

**Work Hardening**

When metal is bent or shaped by hitting with a mallet, the area being reshaped becomes harder and more brittle. This is why it is possible to break a length of steel wire by repeatedly bending it backwards and forwards. Each time it is bent it becomes harder and more brittle until it breaks off.

One problem is that new metal products are likely to have areas that have been shaped and are too brittle. It is possible to get rid of the brittle areas by **annealing** the metal.

**Annealing**

Annealing is the process of heating metal to soften it and remove the brittleness.

METAL	METHOD	COOLING TIME
Aluminium	Put soap on the surface and heat with a blowtorch until the soap turns black (400°C)	Can be cooled by washing off the soap in cold water.
Steel	Heat to cherry red (725°C)	Cool slowly buried in sand.
Copper	Heat to dull red (500°C)	Cool naturally in still air.

**Annealing steel**

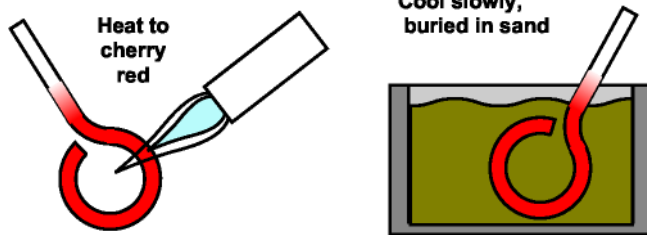

**Hardening and Tempering**

High Carbon Steel is the only common metal that can be hardened by heat treatment.

It is **hardened** by heating to bright red and then cooling it quickly by plunging it into room temperature water. It is now very hard, but unfortunately also very brittle, too brittle to use without it breaking. It needs to be softened a little to reduce the brittleness, this is done by the process of **tempering**.

**Tempering**

1. Clean the area to be tempered.

2. Heat gently until the correct colour appears and moves to the tip. (see table)

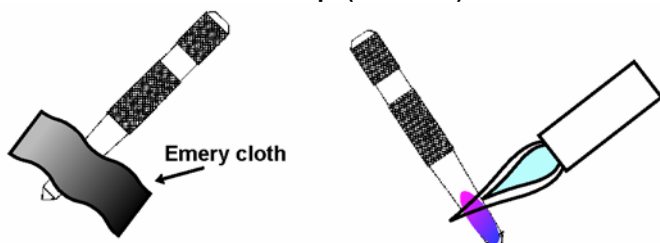

3. Plunge the tip into water and swirl it around. It is now the correct hardness and not too brittle.

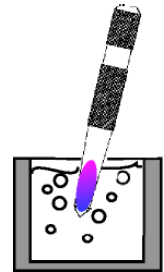

COLOUR	TEMPERATURE	USES
Light brown	240°C (still brittle, not tough)	Drills, milling cutters
Dark brown	270°C (quite tough)	Scissors, knives
Dark purple	290°C (tough, not brittle)	Screwdrivers, spanners

**Case Hardening**

Mild steel cannot be hardened and tempered because it does not contain enough carbon for the process to work. However, if mild steel is heated to bright red heat and then buried in carbon rich powder, the carbon melts and soaks into the surface of the steel to a depth of up to 2mm.

The mild steel can now be hardened and tempered in the same way as high carbon steel. This is known as **Case Hardening**, because only the surface with the extra carbon becomes hard, the inner core of mild steel remains soft.

Hard outer case

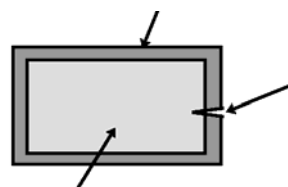

Case hardened mild steel is very tough, because any cracks that start in the hard, brittle outer case are stopped by the soft core.

Soft inner core

**KEY WORDS Annealing: Tempering: Case hardening:**

1. Explain how repeat bending of mild steel wire will result in it breaking in two.
2. What is meant by the term 'annealing'?
3. How would you anneal aluminium?
4. How would you anneal mild steel?
5. How can high carbon steel be hardened by heat?
6. Why does hardened steel need to be tempered?
7. Illustrate the stages of tempering a screwdriver head. (state the colour that you need to heat the blade to).
8. How is mild steel treated so that it can be hardened?
9. Case hardened mild steel is tough. Why?
10. Between the temperatures of 230°C and 300°C, steel can be said to have a built-in thermometer. How can this be true?

## METAL FINISHES

Finishes on metal are used to both protect and decorate the surface. If left unprotected most metals tarnish and eventually corrode.

### Preparation

It is important that the surfaces are cleaned up by removing any dirt, grease and tarnish. The most common method is to use **Emery cloth** (blue or black coloured grit stuck to a cloth backing). The cloth can be wrapped around a file and then rubbed over the surface, up and down in one direction, to give a clean looking finish.

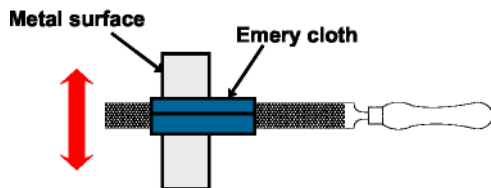

### Polishing

Further prepare the surface by using a finer grade or worn piece of emery cloth to get a smooth matt finish. Polishing can then be done by hand using liquid metal polish and a cloth, or on a **Buffing machine**, by holding the surface against a revolving mop, lightly coated with an abrasive wax.

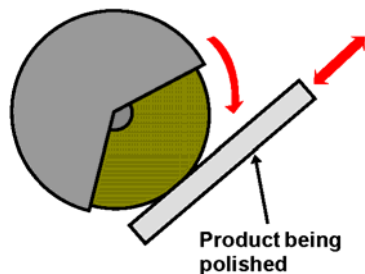

### Safety note

Always use the underside of the buffing wheel so that the product being polished is thrown away from you if it is pulled out of your hand. Never hold the product with a rag, it can catch in the wheel and drag your hand into the machine.

### Painting

The surface should be thoroughly degreased using white spirit. A special primer coat for metal can then be applied. Although normal gloss paint can be used over the primer, an **enamel** gloss is best, as it is less likely to flake off. The toughest paint finish is **Hammerite**. This paint does not require a primer coat, except on aluminium, and can be painted over rust.

**Lacquering** Lacquering metal is similar to varnishing wood. A thin layer of cellulose gum is brushed on the cleaned surface, giving a clear protective coat that will allow the colour of the metal to show through.

**Plastic Coating** A plastic coating is a tough and waterproof finish that comes in a range of colours.

The product to be coated is heated in an oven, or by a blow torch, to a temperature between 200°C and 400°C. It is then plunged into a fluidised bath of polyethylene powder for a few seconds. When it is removed the product should be rotated slowly as the plastic cools and sets, so that no drips occur.

**Fluidising** is blowing cold air through the powder so that the powder bubbles like boiling water.

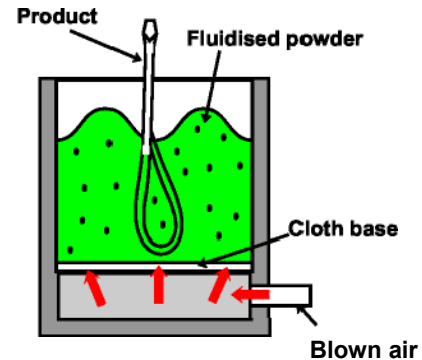

### Enamelling

Enamelling is using powdered coloured glass, which is melted, flows over the surface and then bonds to it. It is normally used as a decorative finish on copper for items of jewellery.

On steel, **Vitreous enamel** is a coating that is used for the casing of washing machines and refrigerators etc.

### Anodising

Anodising is used on aluminium and is a method of producing a dense, clear oxide layer that resists corrosion. The layer can be dyed with coloured inks.

### Electroplating

Electroplating is using a process called electrolysis to coat one metal with a thin layer of another metal. For example, covering brass with chromium for bath taps and nickel with silver (silver plate) for an ornament.

## KEY WORDS Buffing: Enamel: Lacquer: Fluidising: Anodising: Electroplating:

1. Explain the best way of cleaning metal so that it is ready to receive a finish.
2. In what way can a buffing machine be a dangerous machine to use?
3. Why is enamel paint better than standard gloss on metal.
4. What sort of finish would you give brass so that the shiny yellow surface can still be seen?
5. Explain, with diagrams, how the handle of a junior hacksaw can be plastic coated.
6. What method could you use to decorate a pair of copper earrings?

**COMMERCIAL PRODUCTION**

**Blanking and Piercing**

Blanking and piercing are useful processes for producing identical small metal parts such as washers, for use with nuts and bolts. The processes are normally automated and one machine can turn out more than 1,000 washers per hour.

**Piercing** is when a press is used to cut holes of any shape out of a sheet of metal. The part cut out is waste.

**Blanking** is when a press is used to cut out a shape that is to be kept and used. The sheet of metal that it has been cut from is the waste.

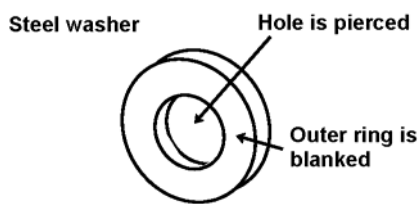

**A Blanking and Piercing Press**

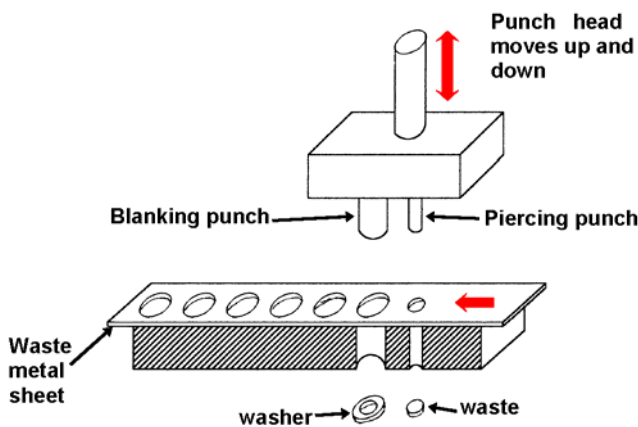

The steel strip is moved forward one position each time the punch head moves up. Each downward stroke of the punch produces one washer and one piece of waste.

**A section view of the Blanking process**

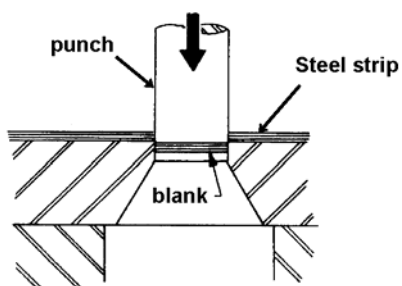

**Presswork**

Shaping sheet metal by pressing it gives a rigid and tough shell structure. Pressure can be applied by a hydraulic ram.

**Drawing a metal cup shape**

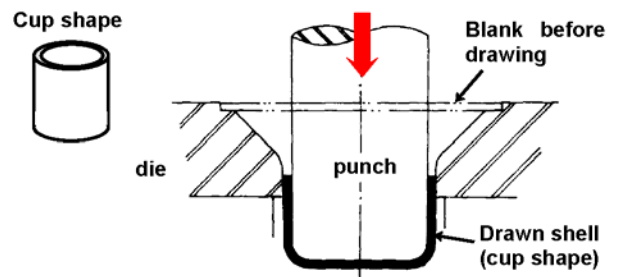

**Pressing a channel shape**

**Two part press**

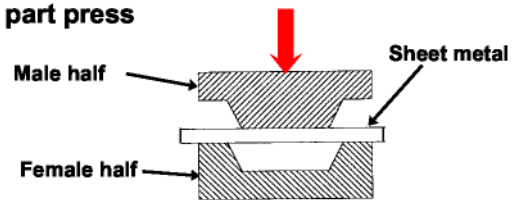

**3D view of press**

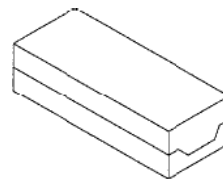

**Finished channel shape**

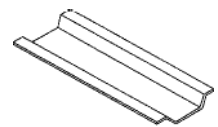

**Extrusion**

An ingot of metal is heated until it is soft. A hydraulic ram then forces the metal through a shaped hole in a die. This process can produce long lengths of the same shape, e.g. aluminium roof guttering can be produced to the length required (no leaky joints).

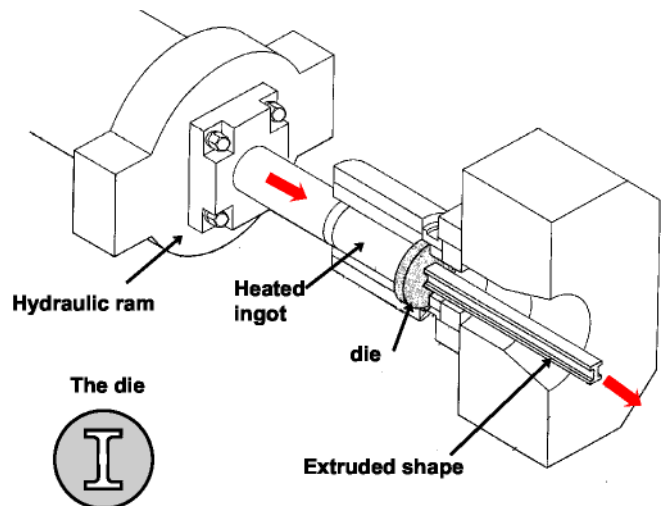

**Rolling**

Cold rolling is a process in which a flat strip of metal is passed through a series of rollers that progressively change it into its final shape. Each set of rollers alters the shape a little bit.

The first four of the seven sets of rollers used for making the channel shape are shown below.

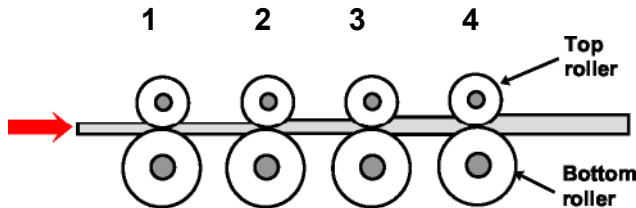

**Enlarged view of completed channel**

A view of each roller in the series, showing how the shape is progressively changed, in seven stages, from a flat sheet to the channel shape.

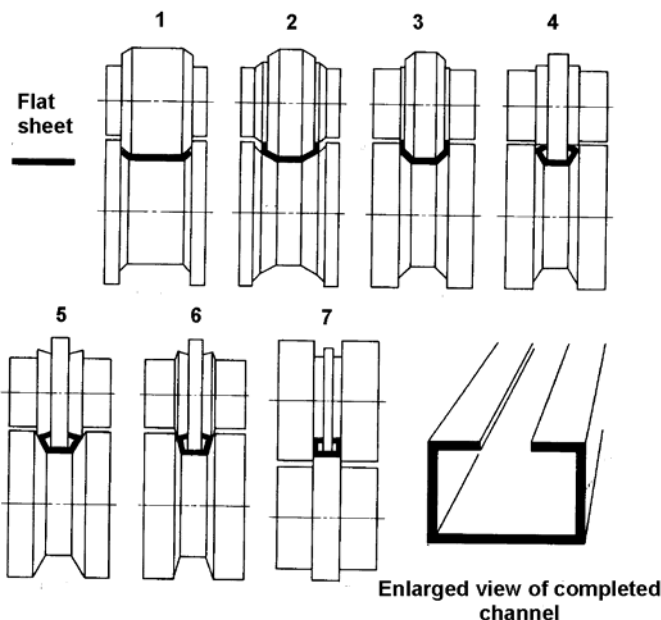

**Die Casting**

Where large numbers of identical components are required, sand casting is not appropriate because the mould has to be broken up each time. Die casting is a method using a permanent mould (called a die). The moulds are made of tough alloy steel and are split into two or more parts to allow the casting to be removed.

The holes to allow the molten metal into the die (the sprues) are normally too small for metal to fall through under gravity. A ram system is normally used to force the metal in under pressure, so the system is often known as **Pressure Die Casting**.

This method is normally automated and can produce over 100 castings per hour.

A two piece die for casting an aluminium handle.

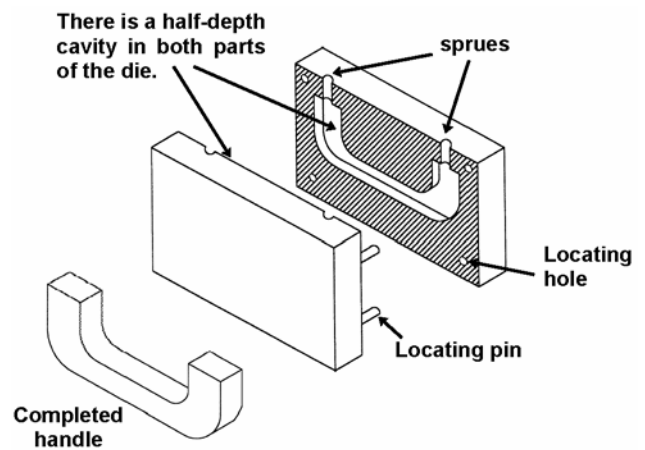

**Lost Wax Casting (Investment Casting)**

This is a very accurate method of casting small items from jewellery to aircraft engine parts.

1. The shape required is formed in wax.
2. The shape is then covered in plaster (called investment).
3. When the plaster is set it is placed in an oven so that the wax can melt and drip out, leaving a cavity of the same shape (the wax is lost).
4. Molten metal is then forced in and sets.
5. Finally the plaster is broken off leaving a very accurate casting behind.

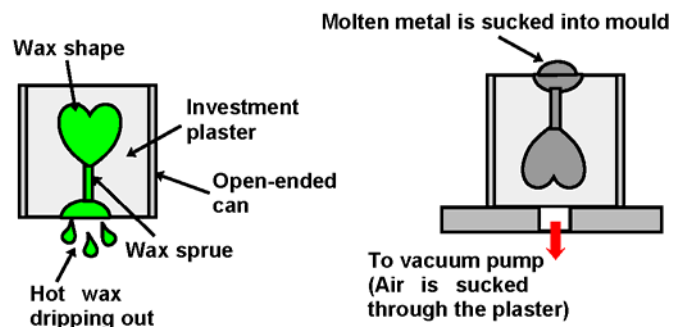

1. What is the difference between Blanking and Piercing in presswork?
2. Illustrate an example of blanking.
3. Show how a metal cup shape can be made without a seam.
4. Illustrate **two** different ways of making a flat steel strip into the shape shown below.

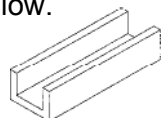

5. The diagram below shows the cross-section of a length of aluminium roof guttering, 8 metres long. Explain how the guttering can be manufactured.



6. Which casting system is most suited for making a large number of identical components and why?
7. Which is the most accurate method of casting?

**KEY WORDS** Blanking: Piercing: Punch: Press: Extrusion: Rolling: Die casting: Lost Wax:



**SELECTING PLASTICS**

There are two main classes of plastic.

**Thermoplastics** - can be reshaped by heating. They will try and return to their original shape if reheated.

**Thermosetting Plastics** - cannot be reshaped by heating and can withstand higher temperatures than thermoplastics.

All modern plastics are made mainly from oil, coal and extracts from plants. They are **synthetic** (not natural - man-made) and come in hundreds of types, each with their own set of properties. Many have been made to order by materials scientists, e.g. The drinks industry wanted a lightweight plastic that would not crack when dropped or when under pressure, to make bottles for fizzy drinks. Scientists produced Polyethylene teraphthalate (PET). (Can you pronounce this?) Most property changes are made by adding additives to the basic plastic.

The following are common additives:

**Plasticisers** - make the plastic less brittle.







**Pigments** - colour the plastic



**Fillers** - powdered additives, e.g. mica reduces electrical conductivity, asbestos allows higher temperature use, etc.

**Stabilisers** - protect plastic from ultra violet light that can make it become brittle.

**Flame retardants** - make the plastic less likely to catch fire.

**Thermoplastics**

	PLASTIC	PROPERTIES	USES
USED IN SCHOOL	Polymethyl-methacrylate (Acrylic or PMMA)	Rigid, hard, can be clear, very durable outside, polishes to a high shine.	Illuminated signs, windows, baths, 
	Polyvinyl chloride (PVC)	Rigid, quite hard, good chemical resistance, tough.	Pipes, guttering, window, frames, 
	Polyethylene (polythene)	Flexible, soft, good chemical resistance, feels waxy	Food bags, buckets, bowls, bottles. 
	Polyamide (nylon)	Tough, self lubricating, resists wear, good chemical resistance	Gear wheels, bearings tights, combs 
	Polystyrene	Lightweight, hard, rigid, can be clear, good water resistance	Model kits, utensils, containers, packaging 
	Expanded Polystyrene	Very lightweight, floats, good heat insulator	Insulation, packaging 

	PLASTIC	PROPERTIES	USES
USED IN INDUSTRY	Polyethylene teraphthalate (PET)	Tough, clear, lightweight,	Fizzy drinks bottles 
	Polypropylene	Lightweight, flexible, resists cracking and tearing	Climbing ropes, crisp packets 
	Acrylonitrile butadiene styrene (ABS)	Very tough, scratch resistant, good chemical resistance	Casings for cameras, kettles, vacuum cleaners 

**Thermosetting plastics**

	PLASTIC	PROPERTIES	USES
USED IN SCHOOL	Polyester resin (mixed with glass fibre - GRP)	Hard, rigid, brittle, tough when mixed with glass or carbon fibres	Boat and car bodies, paper weights
	Epoxy resin (Araldite)	Strong, good chemical and heat resistance, sticks to other materials well	Adhesive encapsulating electronic components
USED IN INDUSTRY	Polyethylene teraphthalate (PET)	Rigid, hard scratch resistant, water and stain resistant	Table ware, laminate top coating
	Urea formaldehyde	Rigid, hard, strong, heat resistant, does not bend when heated, good electrical insulator	Electrical plugs and sockets, door knobs

1. What are the two classes of plastic and what is the difference between them?
  2. Why are there many types of plastic?
  3. Give an example of how a materials chemist can change the properties of a plastic.
  4. Why would you add a stabiliser to a plastic?
  5. Which plastic would you choose for making a window frame and why?
  6. Which plastic would you choose to protect a china ornament sent by post?
  7. Which plastic would you use for making a house number sign and why?
  8. Why is nylon a good plastic for making combs?
  9. Which plastic would be best for making the casing of a cool-wall toaster?
  10. Which plastic has the properties required for making a saucepan handle?
- A** List **five** items in your home that are made of plastic, suggest which plastic you think they are made from, and what the properties of the plastic would need to be.

**KEY WORDS** Thermoplastic: Thermoset: Synthetic:



**MARKING OUT PLASTIC**

Plastic in schools is normally in sheet or rod form. The sheet plastic is often protected on both sides by a layer of paper or clear polyethylene. These layers protect against accidental scratching and therefore need to be kept on as long as possible.

Marking out needs to be done on the protective layer if possible. Normal pencils can be used on the paper layer. The polyethylene layer will need a chinagraph pencil or a spirit based pen such as an overhead projector (OHP) pen. (use a non-permanent pen)

Marking out a line on the protecting paper layer over a sheet of Acrylic

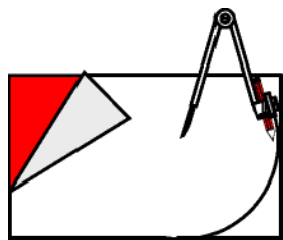
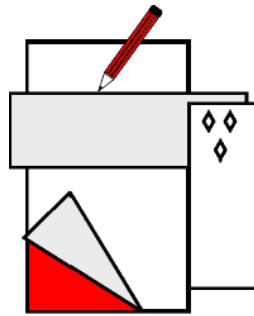

Marking out a curve using a pencil compass.

If the protective layer has been removed then masking tape can be used to cover the area to be marked out.

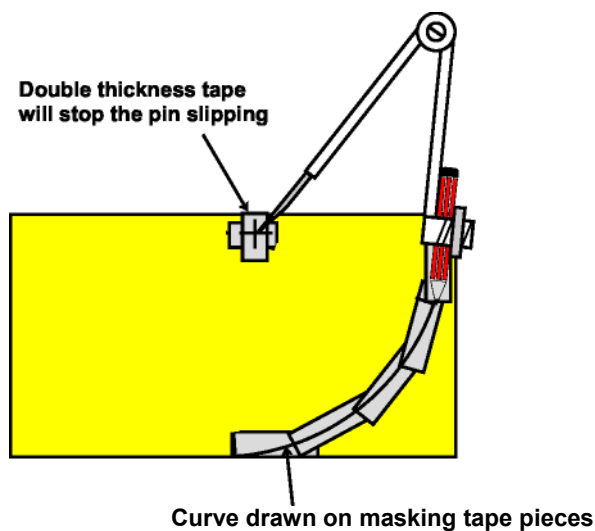

Curve drawn on masking tape pieces

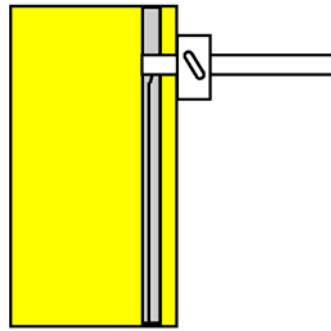

Using a marking gauge to scratch a line along the masking tape. The scratched line can be made clear with a pencil afterwards.

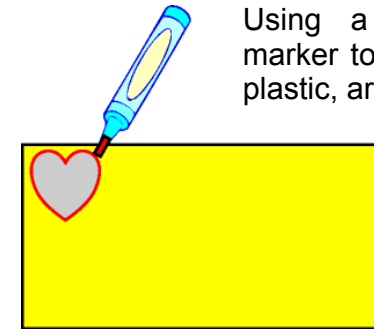

Using a non-permanent spirit marker to draw directly upon the plastic, around a template

**Remember:**

Always mark out in the corner of a sheet of plastic to reduce the amount of waste and to make it easier to cut out.

**Note:**

If the plastic is to be cut out on a scroll saw or band saw, the masking tape will also help in keeping the temperature of the plastic below its melting point, so that the cut does not weld itself back together again.

To find the centre of the end of a length of plastic rod use a **centre square**. The rod should be touching both arms, then a line drawn along the inside edge of the ruler should pass through the centre of the rod. To find where along the line the centre is, turn the rod through 90° and draw a second line, where the two lines cross is the true centre.

Centre square

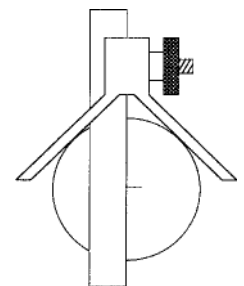

1. Why are sheets of plastic often covered with a layer of paper?
2. What markers can be used on the surface of Acrylic?
3. How can the point of a compass be stopped from sliding over the smooth surface of a sheet of plastic?
4. Give **two** good reasons for using masking tape on unprotected sheet plastic.
5. Illustrate the reasons why shapes should be marked out in the corner of a sheet of plastic and not in the middle.

## SHAPING PLASTICS – WASTING

### Sawing

There are two main problems that occur when sawing plastics.

1. Hard, rigid plastics such as Acrylic and Polystyrene can crack easily if they are not well supported.
2. Power saws tend to create so much friction heat that the cut plastic softens and welds itself back together again behind the blade.

A keyhole support block  
The block is held in a vice.

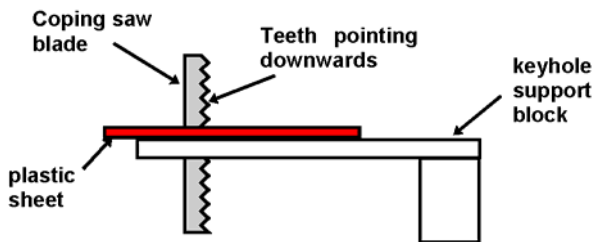
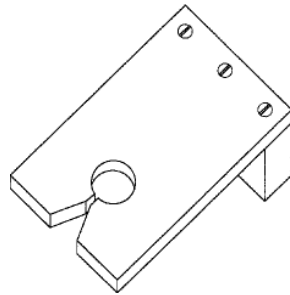

When using a scroll saw or bandsaw the heat problem can be solved by sticking 'sellotape' over the line to be cut, or draw the line on masking tape that was put on for marking out. The tape takes away enough heat from the plastic to stop it welding together behind the blade.

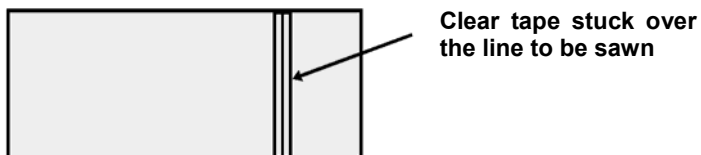

### Planing and Filing

A woodworking plane can be used on the edges of most plastics, provided the blade is set to make a very fine cut. Hard plastics like Acrylic will blunt the blade very quickly. It is best to have a plane set aside for use on plastics only. It is very important to support the plastic when it is in the vice to stop it cracking when pressure is put on it by the plane.

For support, when planing or filing, sandwich the plastic sheet between two wooden blocks with the plastic only just showing above the wood. This is then held in a vice.

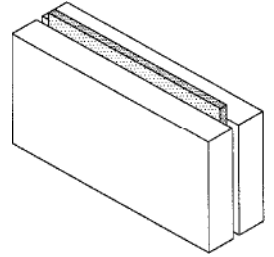

When filing the edge of a sheet of plastic, never file at right angles to the edge, because the plastic may crack. Always file at an angle or drawfile.

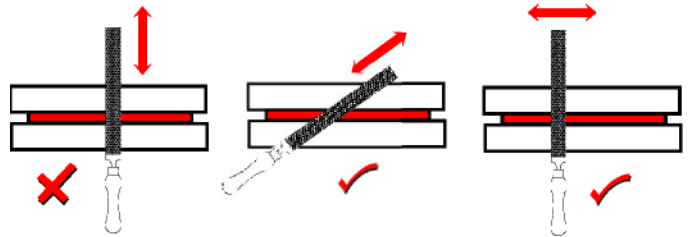

### Drilling

Normal jobber drills that can be used for wood and metal are not suitable for plastic unless they are reground to a different angle. A standard drill will catch the plastic as it breaks through the bottom of the hole and cause cracking around the hole.

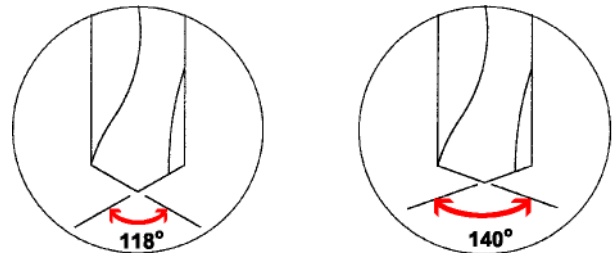

Normal jobber drill

Reground jobber drill

Any hole over 6mm diameter is best drilled using the **pilot hole** method. First drill the hole with a 4mm drill and then redrill with a 6mm drill and continue using drills that are 2 or 3mm larger in diameter until the correct size is reached.

1. What problems do you need to overcome when sawing plastic?
2. Why do you think the keyhole support block works so well?
3. When using a support block, why do the teeth of the blade need to be pointing towards the block?
4. Why should you stick tape over a saw line when cutting plastic with a power saw?
5. Illustrate how you would support a sheet of plastic for planing or filing.
6. Show how you should file the edge of a sheet of plastic to avoid cracks occurring.
7. Why is it not a good idea to use a jobber drill from the store to drill a hole in plastic?
8. Explain how you would plan to drill a 10mm diameter hole in a sheet of plastic.

**SHAPING PLASTICS – FORMING**

**Bending**

Thermoplastics in sheet form can be heated gently to between 160°C and 180°C and then bent into shape. If the sheet is held in position while it cools it will remain in its new shape while it is at room temperature or below. If the plastic sheet is re-heated then it will try to return to its original shape of a flat sheet. This property is known as **plastic memory**.

To bend a straight line use a **strip heater**. A heating element will heat the plastic only along the area held above it. When the plastic in the heated area becomes soft it can be removed and held over a former, or in a jig, to hold it in shape until it cools.

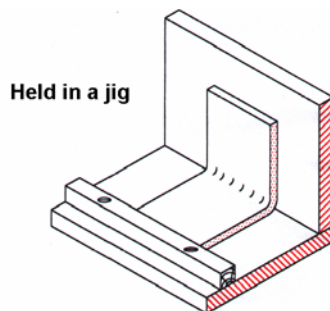
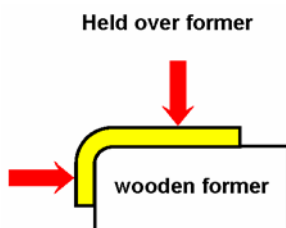
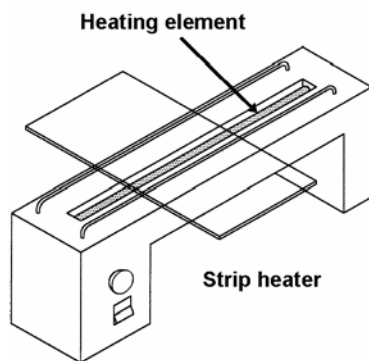

**Relief Patterns**

Plastic memory can be used to create patterns that stick out from the surface of the sheet. Acrylic has the best memory effect for this process.

1. Place a shape made from steel wire or brazing rod on a sheet of MDF.

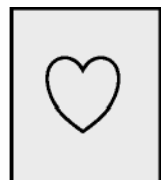

2. Place a plastic sheet, heated in an oven until it is soft, between the shape and a second sheet of MDF. The sandwich is then pressed together so the shape makes an indent in the plastic. Leave to cool. Acrylic

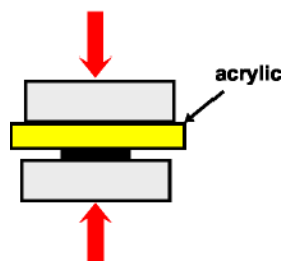

3. Remove the top surface by filing, milling or rubbing over an emery board. Some of the indent must be left. Remove to lower level indent

Remove to lower level

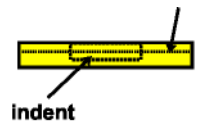

4. Re-heat in the oven until the indented plastic returns to its memorised height. The surrounding plastic has been partly removed and therefore cannot return to its original height.



**Press Forming**

Press forming is also known as **Plug and Yoke** forming. This process is useful for making three dimensional hollow shapes such as a shallow tray. A two part mould is used to shape a heated sheet of plastic.

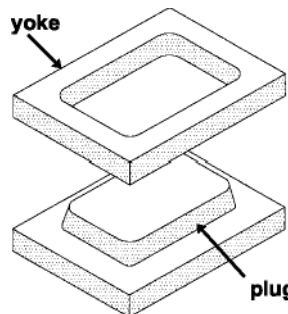

The mould can be made from plywood or MDF. The shape that is the plug is smaller than the hole in the yoke. The difference is the same as the thickness of the plastic to be formed, all the way round.

The soft sheet of hot plastic is sandwiched between the plug and yoke. G-clamps are used to force the plug and yoke together.

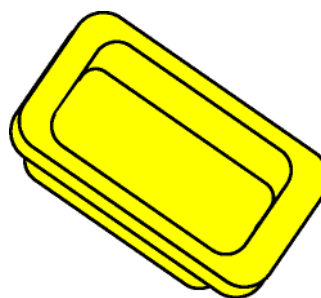
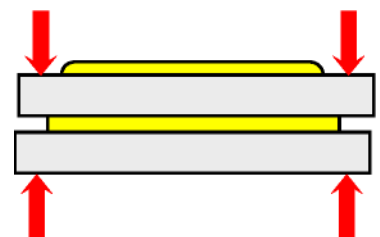

When the plastic has cooled to room temperature it can be removed and will be the required tray shape.

**Vacuum Forming**

Most thermoplastics are suitable for vacuum forming. This process is useful for making shaped packaging trays, such as those that hold a layer of chocolates in a box. Other items made by this process are face masks, the shelving on the inside of refrigerator doors and plastic baths.

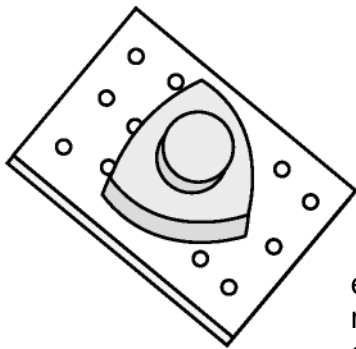

The mould can be made from MDF and is attached to a baseboard made from drilled hardboard or thin plywood.

The sides should be tapered (draft), to make it easier for the plastic and mould to separate at the end.

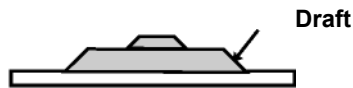

**Vacuum forming machine**

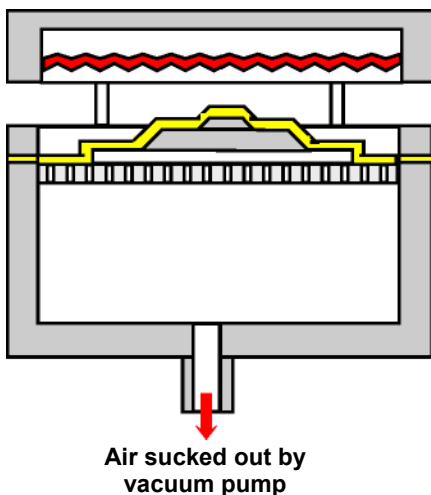
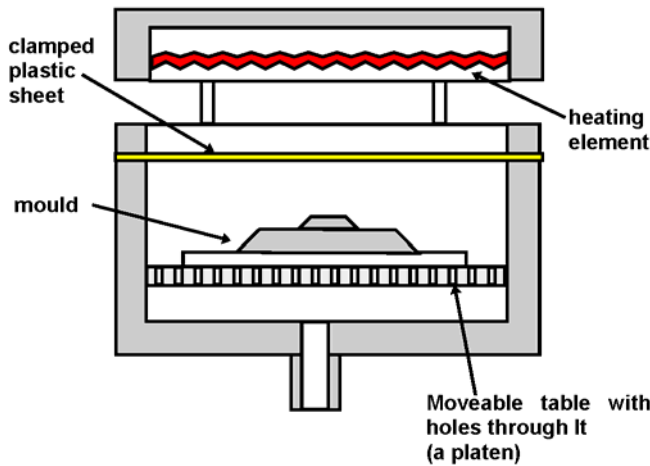

The table with the mould is raised into the plastic and the vacuum pump is switched on. The plastic sheet is then sucked tightly over the mould. The mould can be removed from the plastic moulding when the plastic has cooled.

The waste can be trimmed from the base of the moulding by using a **profile router**. This machine uses a spinning abrasive disc, that can be set at different heights, to cut away the waste flange.

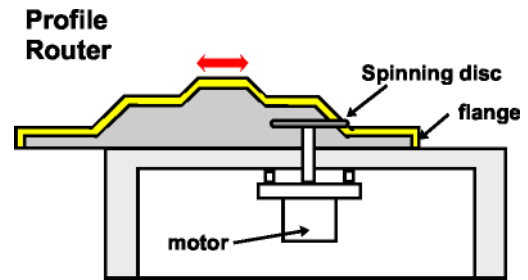

**Blow Moulding**

Blow moulding is a process that can produce hemispherical shapes (half a sphere).

The blow moulding clamp can be made from plywood or MDF.

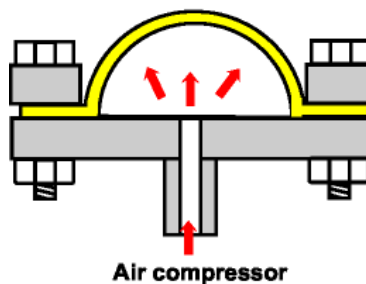
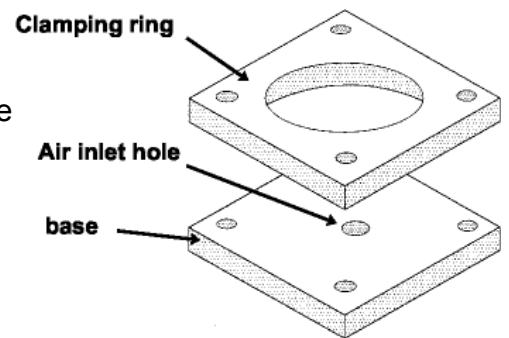

The heated, soft plastic sheet is blown up like a balloon. The air used to blow the hemisphere also cools the plastic so it quickly becomes rigid.

**KEY WORDS Plastic memory: Plug & Yoke: Vacuum forming: draft flange**

1. Explain the term 'plastic memory'.
2. Illustrate how a straight line, 90° bend, can be made in a 3mm thick sheet of PVC.
3. How can a relief pattern be made in a square of acrylic? Use annotated diagrams.
4. A small tray is required to hold salt & pepper shakers. How would you make the tray in rigid polystyrene?
5. Why are vacuum forming moulds made with drafted edges?
6. Illustrate the vacuum forming process.
7. How can the flange be cut away from a moulding?
8. What are the three ways in which a hemispherical shape can be produced from a plastic sheet?
9. Explain, with diagrams, how compressed air can be used to create a half balloon shape in sheet plastic.



### Injection Moulding

In industry, injection moulding is one of the most common methods of producing products in thermoplastic plastics. e.g. school chairs, TV cases, toothpaste tube caps etc. Thermoset plastics cannot be injection moulded because any plastic left in the machine would set hard permanently and block the nozzle.

### Glue Gun Moulding

In school, simple small injection moulded products such as plastic feet for a jewellery box and knobs for drawers in the box can be made by using coloured glue stick

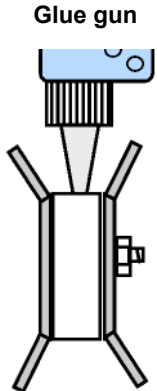
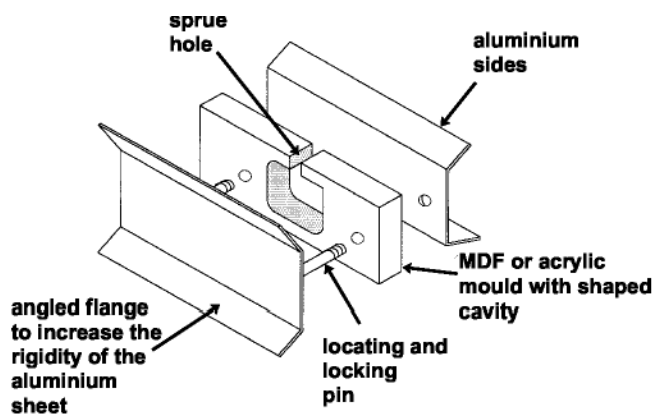

Coloured glue sticks can be used to fill the cavity in the mould through the sprue. If MDF is used for the mould the walls of the cavity need to be thickly pencilled over. The graphite in the pencil lead prevents the hardened glue from sticking to the MDF.

1. Plastic granules from the hopper are forced by the combined screw and ram into the heated area.
2. The plastic melts and is then forced under high pressure through the sprue hole into the split mould.
3. The mould is cold and the plastic cools and sets quickly.
4. The mould is opened and the product is ejected.
5. The sprue is cut away. The product is now ready for use.

### Glass Reinforced Plastics (GRP)

Fibres of glass are mixed with the thermoset plastic called **Polyester**, in liquid (resin) form. The resulting material, after the resin has set, is very tough because any crack that starts in the polyester stops getting longer and larger when it reaches a glass fibre.

### Making a model boat hull in GRP (the lay-up process)



enlarged section view of split mould

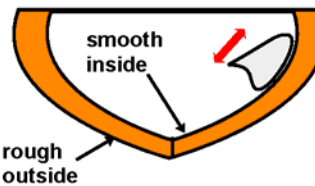

A. A layer of release agent is applied to the inner surface to stop the new GRP from sticking to the mould. The release agent can be in wax form.

B. A thick layer of coloured gellcoat resin is painted over the release agent.

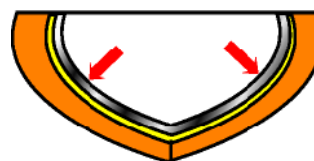
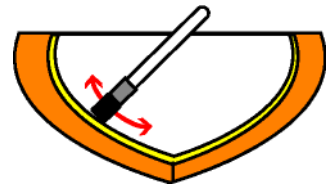

C. A sheet of glassfibre is laid by hand over the dry but sticky gell coat layer.

D. Polyester resin, the same colour as the gellcoat, is stippled onto the glassfibre until it is covered with resin. This is then allowed to set before the hull is taken out of the mould.



### Section view of an Injection Moulding machine

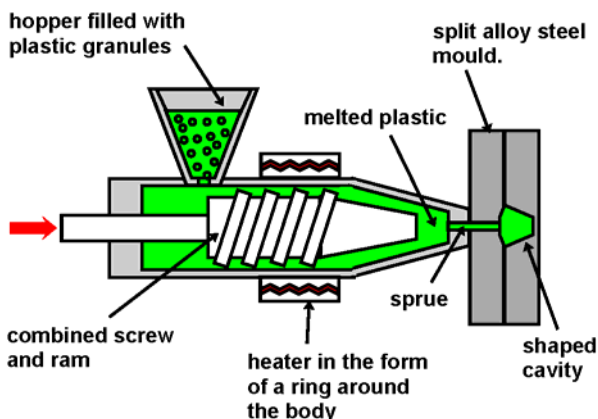

1. How can a glue gun be used to create six identical plastic counters for a board game?
2. Why cannot thermoset plastics be used in an injection moulding machine?
3. How does an injection moulding machine work?
4. Explain the stages used in the lay-up process, when making a product from GRP.



## JOINING PLASTICS

### Mechanical fixing

Rigid plastics such as Acrylic can be drilled, tapped and held together with **screws** suitable for metal. (see worksheet 29b)

Lightweight flexible plastic can be joined by plastic **rivets**. The rivet comes in two parts, which are snapped together when in place.

Separated rivet ready for use

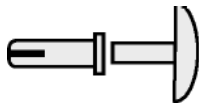

Snapped rivet in use

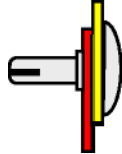

Rigid sheets of plastic can be clipped together using using a two part plastic 'Octaclip'. Angles of 90°, 45° and 180° are possible.

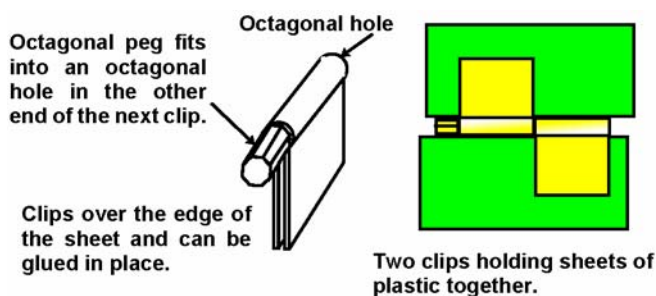

The clips can have a revolving peg which makes them suitable for use as hinges.

### Adhesive fixing

Adhesives used for plastic are often called **plastic cements**. The cement works by dissolving the surfaces of the plastics that they are applied to and then evaporating dry. When two plastic surfaces are joined by a cement, the surfaces both dissolve to a depth of approximately 0.25mm; the dissolved plastic mixes together and then sets as one piece when the cement evaporates away. It is therefore very important that the joining surfaces are completely clean when the cement is applied. The best cleaning method is to rub the surfaces with wet & dry abrasive paper.

A commonly used cement is '**Tensol No.12**', for Acrylic.

Any cement spillage or seepage from the joint will permanently mark the surface. To stop this, masking tape is used to cover and protect the surfaces in the area of the joint. The joint needs to be held together for between 30 mins and 1 hour. (the longer the better)

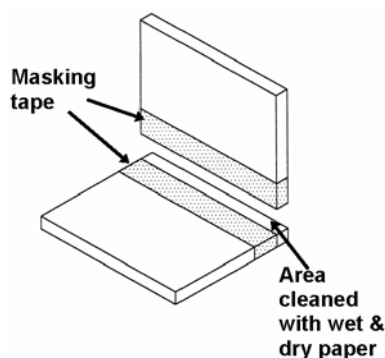

### Caution:

Cements are spirit based and can cause major problems if sniffed. They should only be used in very well ventilated areas, by an open window, or outside if possible.

### Adhesive tape

When large areas of contact are involved, such as overlapping sheets of plastic, **double sided tape** can be used. This is not a suitable process for edge joining.

Double sided tape

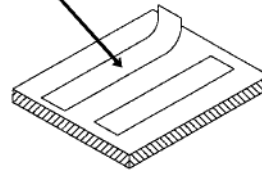

The positioning must be exact because the tape will not allow the pieces to be slid into place.

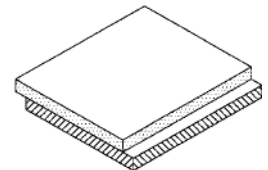

### Welding

Soft plastic sheets, such as those made from polyethylene, can be welded together using a heated tool.

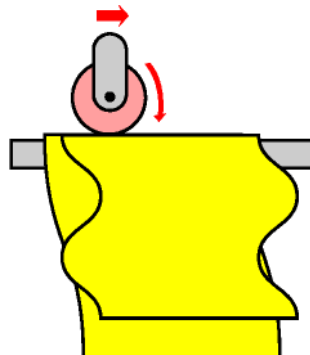

A heated wheel tool, welding together two sheets of polyethylene, along a straight line. This method can be used for sealing plastic bags.

**KEY WORDS** Plastic cement: Double sided tape:

1. You need to hold two sheets of PVC together at an angle of 45°, as shown below. Show how you would do this. 
2. Why do you need to use masking tape when making a joint with plastic cement?
3. Explain a safety hazard associated with using a plastic cement.
4. Under what circumstances can you use double sided tape to join two plastic sheets together?
5. Explain how you can weld two sheets of polyethylene together.

## FINISHING PLASTICS

Plastics do not require a finish for the reasons that wood and metal do. Plastics do not rot or corrode. However ultraviolet light from the sun does affect some plastics, such as PVC. The PVC, after a number of years outside, becomes brittle and shatters easily. This can be avoided by either painting it, or using UPVC, a plastic that has had a special additive added when it was manufactured.

### Edge finishing

When an edge has been sawn it is very rough and needs to be made smooth and shiny to match the sides.

When you want a perfectly straight edge it is best to remove the roughness by rubbing the edge over a board that has wet & dry paper attached. Start with a coarse paper and end with a fine paper. Wet the paper with water to get a finer finish

A convex curve can also be finished on a wet & dry board.

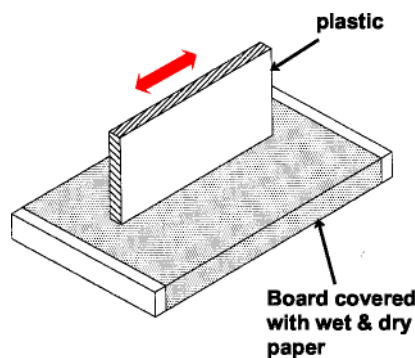
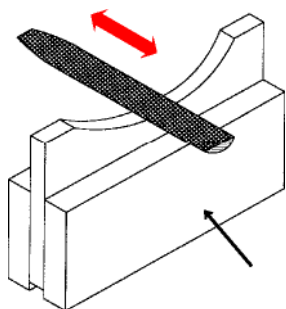

If the edge is a concave curve then a metalworking half round file can be used.

MDF support pieces used to protect the plastic surface from the vice jaws and to stop the plastic from cracking.

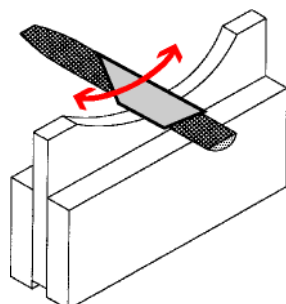

A finer surface finish is possible by drawfiling with wetted wet & dry paper wrapped around the file.

A very high polish can be obtained by using a buffing wheel coated with a light abrasive wax. To stop the plastic from overheating and burning, move the plastic towards you once and let it cool for a few seconds before making a second pass. Repeat the passes with a cooling break between each one until a high polish is gained.

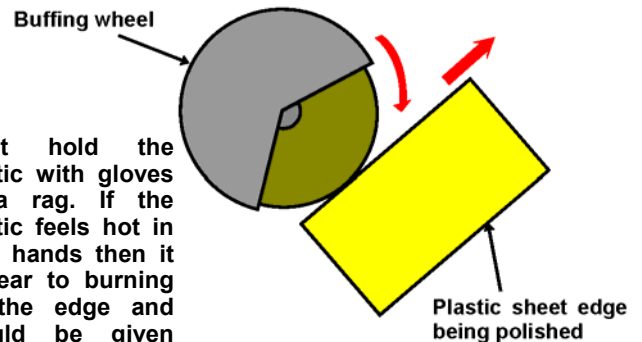

Don't hold the plastic with gloves or a rag. If the plastic feels hot in your hands then it is near to burning on the edge and should be given time to cool down.

### Removing surface scratches

Scratches on the face of the plastic can be removed by rubbing the scratched area with metal polish and a rag. This is a slow process, but it is the only one available. So take extra care not to damage these surfaces. **Keep the protective paper on for as long as possible.**

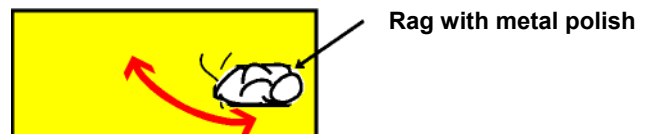

### Decoration

Coloured decoration can be applied to plastics by using permanent spirit marker pens. Any unwanted lines can be removed by using white spirit as a solvent.

A spirit marker decoration on a sheet of Acrylic.



1. How can plastics degrade in use outside and how can the problem be solved?
2. What is the best way of smoothing a straight or convex edge?
3. What treatment would you give a concave edge to make it smooth?
4. What precautions would you take when using a buffing wheel to stop the plastic from burning?
5. How can scratches be removed from the front and back of a sheet of plastic?

**COMMERCIAL PRODUCTION METHODS**

Over the past forty years plastics have replaced traditional wood and metal materials for making products and parts of products. Some advantages of using plastics are:

- They do not rot or corrode
- They are light in weight
- They are easy to use in mass production
- They come in a vast range of colours
- They can be clear and transparent
- Lubrication is not required for moving parts
- Moving parts work more quietly

The most common production method for producing products in plastics is **Injection Moulding** (see worksheet 35d).

This process is only suitable for thermoplastics.

**Compression Moulding**

This method is used for thermoset plastics and produces products that need to resist heat, such as saucepan handles, hairdryer casings, mains electric sockets, etc. **A)** The exact amount of powdered or granular plastic is placed in the mould. **B)** The two halves are then closed and great pressure is applied. **C)** The combination of the heat from the moulds and the pressure melts the plastic and it fills the cavity without any waste. **D)** The mould opens and the plastic product cools and sets. **E)** The product is then ejected from the mould by ejector pins.

**Split mould for a saucepan handle**

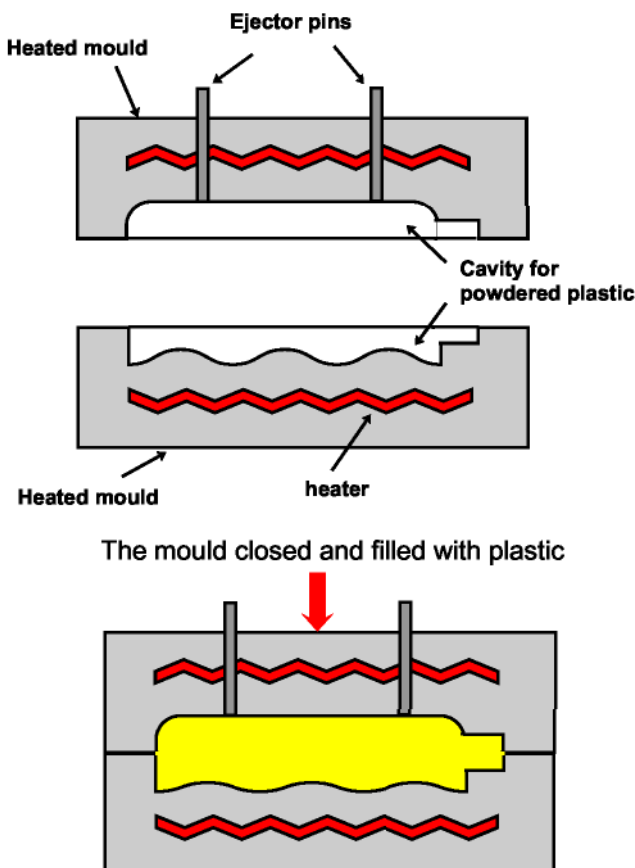

**Extrusion**

This process is similar to squeezing toothpaste from a tube, the paste comes out with the same circular cross-section shape as the hole in the tube.

The machine is very similar to an injection moulding machine, except that the ram is replaced by a screw system that continuously feeds plastic granules through the machine. This means that very long lengths of plastic can be produced.

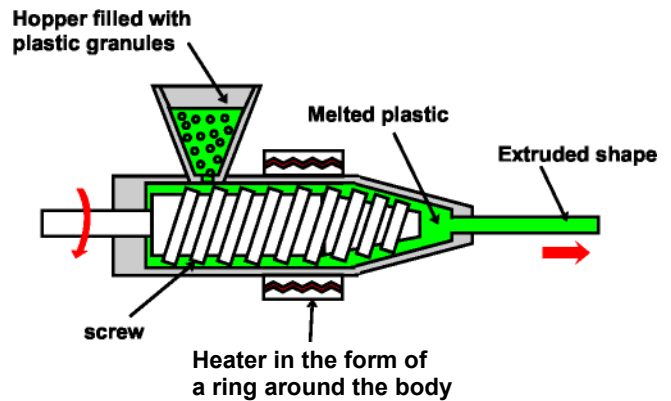

**Typical extruded cross-sections**



**Extrusion Coating**

Extrusion is used for covering electric wires. A special head is attached to the nozzle of the extruder. Bare wire is fed in and turned 90°, to be coated with PVC.

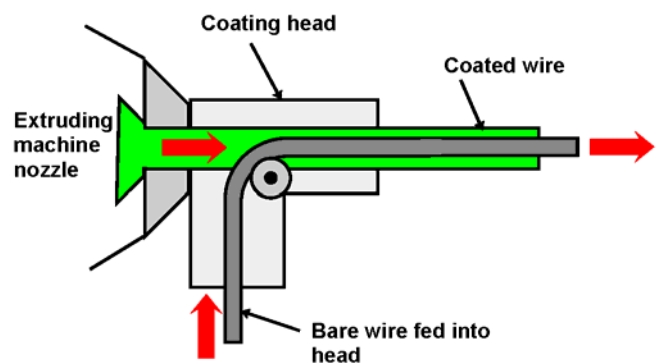

A short length of coated wire.



### Extrusion Blow Moulding

This process is used for producing plastic bottles. An extruding machine is placed vertically above the moulding machine and extrudes a tube of hot, soft plastic directly into the bottle mould.

A typical plastic used for this process is HDPE (High Density Polyethylene).

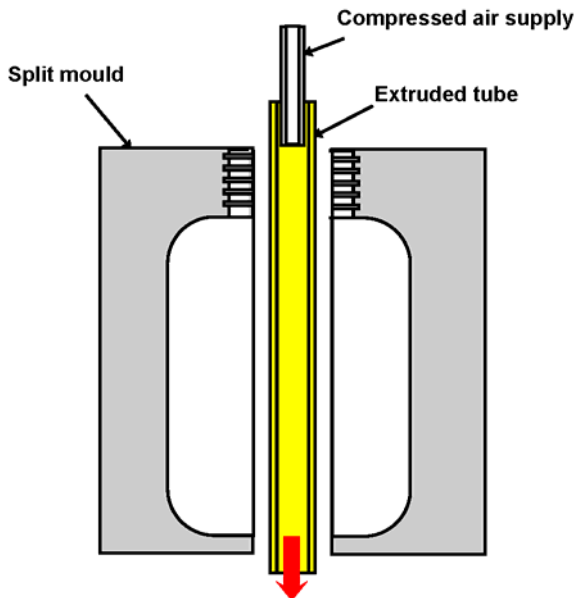

The mould is closed and compressed air blows the trapped tube of plastic to the sides of the mould. The air is cold and cools the plastic so that it sets quickly.

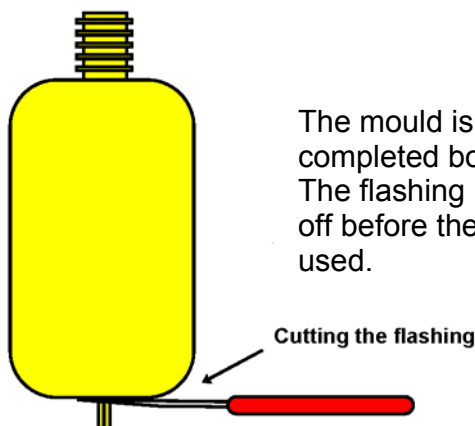
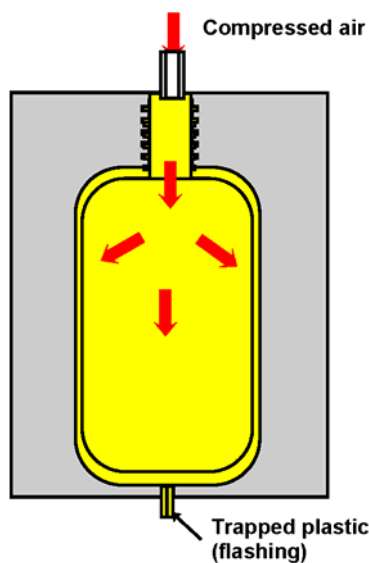

The mould is opened and the completed bottle is ejected. The flashing needs to be cut off before the bottle can be used.

### Rotational Moulding

This process is used to make thick walled, hollow products like dustbins, water tanks and oil tanks.

1. The correct amount of powdered plastic e.g. High Density Polythene, is put inside the mould.
2. The mould is closed, heated and slowly rotated in two directions at the same time. The powder melts and evenly coats the walls of the mould.
3. The still rotating mould is cooled with a cold water spray until the plastic inside has set. The mould is then split open and the product removed.

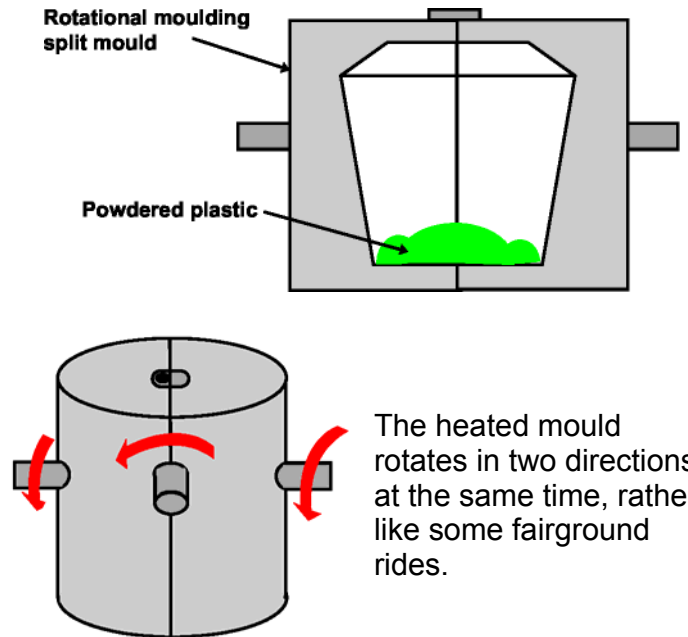

The heated mould rotates in two directions at the same time, rather like some fairground rides.

**KEY WORDS** Compression moulding:  
Extrusion: Blow moulding:  
Rotational moulding:

1. Give **five** reasons why plastics have replaced traditional materials in product design.
2. Explain how it is that thermosetting plastics can be used for compression moulding, but not for injection moulding.
3. What device is used to remove plastic mouldings from a mould?
4. What process would you choose to make a plastic curtain rail and why?
5. Explain, with the aid of a diagram, how an electric wire is coated in PVC.
6. Draw an annotated diagram showing the main features of extrusion blow moulding.
7. In the rotation moulding process, why does the mould have to be rotated in two directions at the same time?
  - A. Identify **five** plastic products or parts of products from home or school and suggest which commercial process you think was used for making them. Give reasons for your choices.



**SMART MATERIALS**

A smart material is a material that can be controlled. It can be made to change its colour, size or shape and be returned to its original form at will.

The control input can be changing the temperature of the material, applying an electric current through the material or by applying pressure to the material.

**Shape-Memory Alloys**

Shape-memory alloys (SMAs) have two distinct molecular structures at different temperatures. If they are reshaped when cooled, they will return to their original shape when heated back to room temperature.

The nickel-titanium alloy, Nitinol, is used for medical and space components, fasteners, water sprinklers and pipe connections.

e.g. Nitinol can be used to make a self-opening split rivet. The diagram below shows sheet metal riveted to square tubing. You cannot easily get inside the tube to open the split rivet.

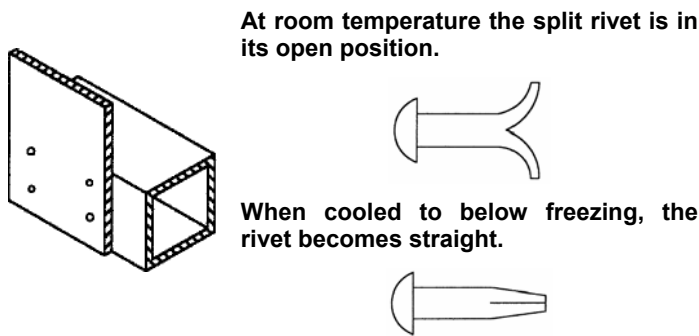

When cold and straight the rivet is placed through the hole and is allowed to heat up to room temperature. The rivet then opens up inside the tube and holds the sheet and tube firmly together.

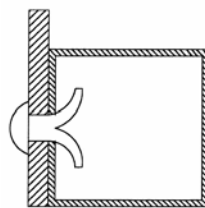

The diagram shows an artificial hip joint. When it is cooled the teeth lie flat and allow it to be inserted into the top of the thighbone.

When the temperature of the joint rises to that of the body, the teeth curve out and grip the inside of the hole in the bone and stop the joint from moving.

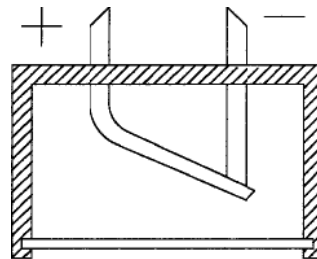

The diagram shows a detector for a fire alarm sprinkler system. When a fire raises the temperature, the positive (+) contact straightens and breaks the circuit, this will trigger the sprinklers.

Glasses frames that remember their shape are made from a SMA. If the glasses are sat upon and the frames are twisted, the alloy remembers its room temperature shape and returns to it.

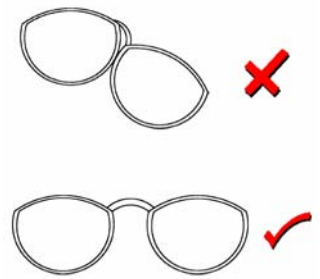

**Shape-memory Plastics**

Shape-memory plastics (SMPs) are also being developed. Different plastics have different recovery temperatures. There are currently five grades that change shape between 40°C and 80°C. These can be used to sense temperature change because they change shape when a certain temperature is reached.

1. What is special about a smart material?
  2. What are the methods used to control smart materials?
  3. What do SMA and SMP stand for?
  4. Which metals make up the alloy Nitinol?
  5. Explain, with diagrams, how you use a Nitinol split rivet.
  6. How can Nitinol be used to prevent fire damage?
  7. How can a person with a hip problem be helped by an SMA?
  8. Give an example of how an SMA can self-repair damage.
- A** Describe fully three possible uses for SMP material.
- B** Design a household or garden product that might make use of SMA or SMP materials.

**KEY WORDS Smart: SMA: Nitinol: SMP:**



WORKSHEET 2

- Whenever you see the word automatic or 'auto', connected with a product you know it's based upon a system that it can control.
- Input - Process - Output.
- A black box is a system that you know how to operate and you know what it does, but you don't know how it works.



- When a system can sense a change in the environment and use the data to control it's actions.
- An open loop system includes feedback a closed loop does not.

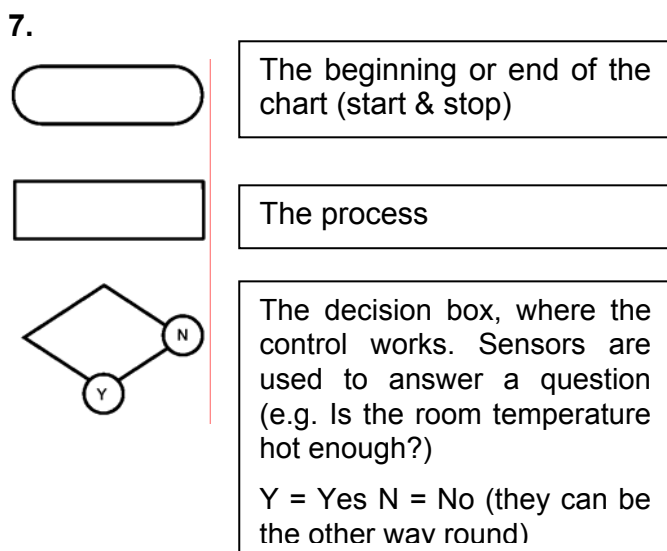

- |          |           |          |
|----------|-----------|----------|
| Light    | Heat      | Sound    |
| Pressure | Tension   | Position |
| Movement | Vibration | Speed    |
- In more complex systems such as those found in an automatic washing machine or a DVD player there are a number of linked systems called sub-systems that work together to make the product work correctly.
- In a DVD player there are a number of sub-systems:

- The disc feed sub-system
- The disc spinning sub-system
- The laser movement sub-system
- The laser reading sub-system
- The conversion for TV sub-system

They must all work together and feedback information to each other for the player to work well.

WORKSHEET 3b

- Any mechanical system.
- Input** – the energy put in, e.g. the squeezing together of the handles of a pair of scissors.

**Process** – the movement of the mechanism, e.g. the movement of the scissors blades.

**Output** – the work done, e.g. the cutting of paper by the scissors.
- Appropriate diagrams
  - linear
  - reciprocating
  - rotary
  - oscillating

- To help you remember which is which, try to learn the rhyme **1 2 3 – F L E**  
(F L E are the initial letters of what is in the middle)

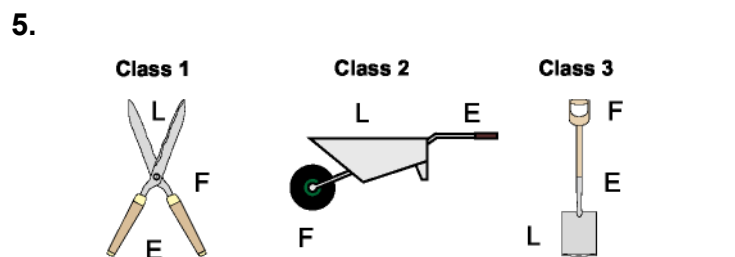

- When a mechanism such as a lever improves the effect of an effort, the mechanism is said to have provided a **Mechanical Advantage (MA)**. To work out what this is, the following formula can be used

$$MA = Load \div Effort$$

- MA = 5
- Since the effort and the load started to move at the same time and stopped at the same time, but the effort moved twice as far, the effort moved faster than the load. The difference between the two speeds is known as the **Velocity Ratio**.

$$Velocity\ Ratio = \frac{Distance\ effort\ moves}{Distance\ load\ moves}$$

- VR = 3
- Torque = 2 Nm

**WORKSHEET 3d**

1. The load moves 2M
2. The **Mechanical Advantage (MA)** of a pulley system is the same value as the number of pulley wheels.
3. Largest load = 60N
- 4.

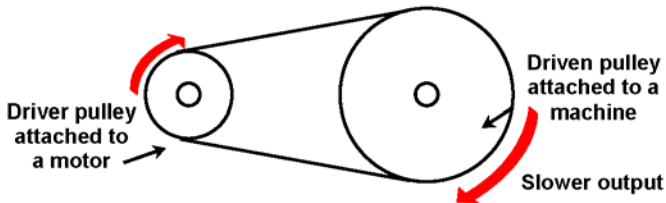

5. Speed ratio is  
**Dia of driver pulley ÷ Dia of driven pulley**

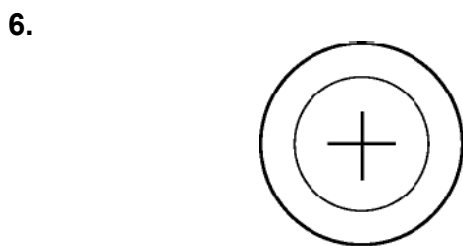

- 7.
- Gear ratio = Number of teeth on driver gear ÷ Number of teeth on driven gear**

8. 300rpm
9. Two meshing gears turn in opposite directions. To get the driver and driven gears to turn in the same direction an idler gear needs to be added to the system.
10. 20rpm

**WORKSHEET 3e**

1. Cams are used in mechanisms to change rotary motion to reciprocating (backwards and forwards) motion.

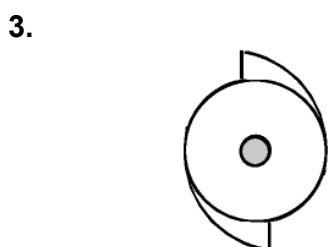
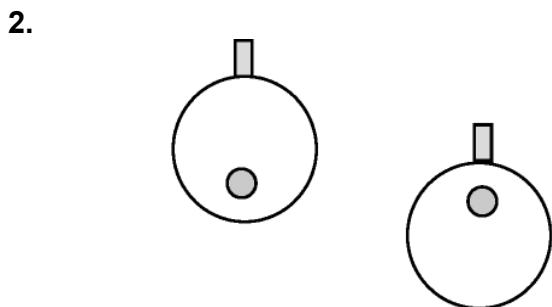

4. Four times faster.

**WORKSHEET 4**

1. **Frame** - made up of beams connected together, e.g. Electricity pylons, some bridges, etc.

**Slab** - made up of boards connected together, e.g. Boxes, chipboard based furniture, etc.

**Monocoque or Shell** - made from shaped sheets of rigid material, e.g. Car bodies, cans, etc.

**Flexible** - made from flexible sheets of material, e.g. Air beds, blow-up furniture, etc.

2. **Note:** Most rigid structures need to be able to flex a little without breaking up, e.g. the forks on a bicycle must flex when it ridden over bumps in the road and a skyscraper must sway in a high wind.

3. Tension, Compression, Bending, Torsion, Shear

- 4.

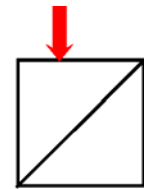

A rigid gate structure

- 5.

Top surface is compressed and is shorter

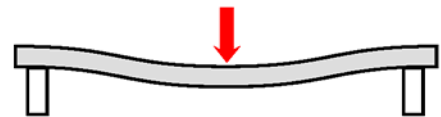

Bottom surface is stretched and is longer

**WORKSHEET 5b**

1. **Density** Is the amount of matter (mass) in a material. A cube made from a high density material will be heavier than the same size cube made from a low density material.

Gold & Lead

2. **Fusibility** Is a measure of how easy it is to melt the material. The temperature at which the material normally melts is known as the **melting point**. **Note:** A highly fusible material has a low melting point.

Zinc & Lead

3. Wood & Polystyrene

4. Copper or Gold

5. There also materials like some plastics or frosted glass that let some light through, but detail of what is on the other side of the material cannot be seen, these are known as **Translucent** materials.

## WORKSHEET 5b (CONT.)

6. A force will **deform** a material. If the deformation is temporary and the material returns to its original state then it is said to be **elastic**.

7.

**Tensile strength** - resists stretching e.g. High tensile steel



**Bending strength** - resists bending - is **rigid**.  
E.g. woods



**Shear strength** - resists sliding forces such as those made by scissors  
e.g. Stainless steel

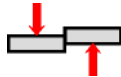

8. Ductility.

9. **Malleability** Is a measure of how easily a material can be permanently deformed by compressive forces. e.g. hammering, without cracking.

10. **Toughness** Is a measure of how well a material can stand up to sudden forces, e.g. A hammer blow, without cracking. A material that is not tough is called **Brittle**.

## WORKSHEET 7b

1. When parts have to fit together.

2. Incorrect measuring when using a ruler.

3. A template is an accurately formed shape, made from a rigid material. The template can be drawn around or followed repeatedly without wearing away. These are particularly useful for irregular shapes.

4.

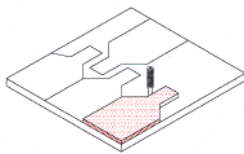

5. Guiding tools.

6. Jigs are used to ensure that dimensions are always accurate. They are particularly useful when the positioning of holes and bends are important.

7. Lining up holes, bending in the correct position, lining up saw cuts, etc.

8. The work piece can slip if it is not clamped in place.

9. To allow the rod to be passed over the pin position, so that a reverse curve can be bent afterwards with the pin back in position.

10. Mild steel.

## WORKSHEET 8

1. Computer aided design / computer aided manufacture.

2. Dimensions added automatically, views can be twisted and turned and viewed from any angle.

3. Faster accurate drawing, common parts can be inserted from a drawings bank, changes can be made quickly and easily, dimensions can be added automatically, printouts can be too any scale, in 3D the object can be viewed from any angle.

4. The cost of the computer and programs. Early ideas can be recorded faster by sketching. A pad of paper and a pencil can be used anywhere.

5. In the CAD/CAM system, data from the CAD drawing is downloaded to the CAM program which is then used to control the cutting machine.

6. Injection moulding, compression moulding, vacuum forming and extrusion of plastics can all be done by computer controlled machines.

7. Up to 500th of a millimetre.

8. A computer can also be used to control the handling of the parts to be cut from one machine to another. Computer controlled fabrication (joining parts together) is also possible. Parts can be automatically held together in the right positions, while they are welded, riveted or glued by computer controlled equipment.

9. Very accurate work The machine does need breaks The machine does not get tired and inaccurate Changes of design can be made quickly.

10. The cost of the computers and programs. The high cost of the machine. The loss of jobs.

## WORKSHEET 9a

1. **One-off** - Producing one product at a time. This method is often used by traditional craftsmen and artists, who work to order.

2. **Advantages:** The customer gets a product that is designed exactly as they want it. Quality checks can be made at every stage of manufacture.  
**Disadvantages:** The production process is slow and costly.

3. **Batch Production** - Is used where the need for a product is not continuous, or not enough are sold to make mass production worthwhile e.g. room heaters, and one style of calculator. Batch production often looks like mass production, but it uses machines that can be altered to make another model, or something completely different.

**WORKSHEET 9a (CONT.)**

**4. Advantages:** Flow production methods lower the production cost. Model changes can be made regularly upon change over.

**Disadvantages:** No production occurs while the machines are being reset The products need to be stored until there is a demand for them.

**5. Mass Production** - Is used where there is a continuous demand for large quantities of a product. E.g. Tin cans for food, cars, etc. Sometimes called **flow production**, this system is organised so that specially designed machines carry out one operation on the product, that is continuously passed from one different machine to the next, until at the end of the line it is complete and finished.

**6. Advantages:** Low production costs if sufficient products are made.

**Disadvantages:** Models cannot be changed easily. If one machine breaks down the whole line is effected. The machines cannot be easily reset to make other models. The machine cost a lot to purchase.

**7. Computer Integrated Manufacturing**

**8. Stock control, production planning, marketing, sales, research and development, CAM manufacturing, quality control.**

**9. Each department uses computers, the CIM system links all the computers, so that everyone involved can see what is happening, with regard to the product, in the other departments.**

**10. One-off.**

**WORKSHEET 9c**

**1. Do what it is meant to do excellently Last a long time. Need little maintenance.**

**2.**

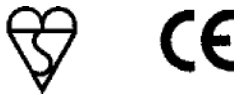

**3. The company can organise itself so that every employee tries to work with quality in mind, including those not directly involved in the making of the product, such as managers and office staff. When a company has done this they can apply to be inspected to see if they are good enough to be awarded the ISO 9001.**

**4. To make sure the product meets the required safety standards and to maintain consumer confidence. Also to make sure that parts fit together and do not have to be rejected.**

**5. The amount that a dimension can vary without affecting performance is known as the tolerance.**

**6. Lengths, widths and depths. Positions of holes and their diameters. Angle measurement Surface flatness and smoothness.**

**7. Checking each part of a product every time it is manufactured costs a lot of money and is normally only considered for the most expensive, top of the range products.**

**8. By identifying a trend of a machine to produce out of tolerance parts, before the tolerance has been reached.**

**9.**

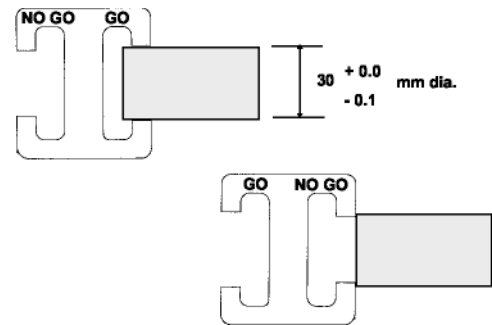

**10.**

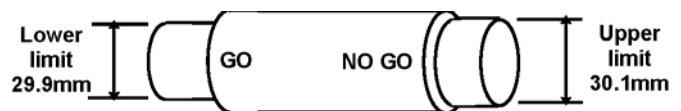
**WORKSHEET 9d**

**1. This analysis process involves collecting data at each stage of the manufacture and use of a product, from the extraction of the raw materials, to the problems it produces when it is thrown away at the end of its life. This data is about:**

- The cost of getting the raw material.
- The cost of converting the raw material into a usable material.
- The amount of recycled material used in the product.
- How much time energy and waste is involved in the
- How much material, time and energy used in packaging.
- How easily it can be disposed of safely, or recycled.

**2. The aims of responsible manufacturers are:**

- To reduce the amount of energy used in manufacturing the product.
- To make a product that lasts a reasonably long time.
- To make it as recyclable as possible when it is worn out, or out of date.

## WORKSHEET 9d (CONT.)

3. Recycling is processing old material to make it good enough to be used as new. Reused refers to materials that can be used for other purposes, or products that can be cleaned and used again.

4. Put in a bottle bank. Sorted for colour. Broken up. Melted down. Used as new glass or added to new glass.

5. The government's policy can be called the '4Rs' policy.

**Reduction** - Reduce the production of waste in the first Place.

**Re-use** - Clean and re-use products, e.g. Bottles.

**Recover** - Recycle paper, glass, cloth, steel and Aluminium, etc.

**Remove** - Remove as little as possible and try and gain energy from burning the waste or collecting methane gas from a landfill site.

## WORKSHEET 10a

1. A new problem needs to be solved. New technology makes the old design obsolete. Fashion changes and old designs don't sell. Novelty, a manufacturer needs their product to be different from their rivals.

2. Often a company will carry out **market research** to see if there is a need for the product they intend to design and manufacture. One way of doing this, is by asking the general public to answer a questionnaire containing questions about the problem and what they see as a possible solution.

3. :

**WHAT** is the situation? E.g. What happens to the controllers without storage?

**WHY** does this cause a problem?

**WHEN** does this cause a problem? E.g. Is the user likely to be standing or sitting at the time?

**WHO** does the problem effect? E.g. who will want to find the controllers quickly?

**WHERE** will the solution be used? E.g. Which room and where in the room?

4. A brief is a short statement explaining the problem and suggesting a possible solution.

5. Analyse rival products. Investigate new technology and new materials. Check fixed data.

## WORKSHEET 10h

1. The Designer Specification is a list of all the factors that must be right if the design is to be successful.

2. Four selected from: Function, Shape, Size, Aesthetics, Storage, Manufacture, Materials, Finish, Safety, Ergonomics, Cost, Pollution, Market.

3. Regularly throughout the rest of the design process.

4. Isometric and Oblique.

5. Crating the drawing first.

6. Add notes.

7. Trying out small changes to your chosen idea, to improve it. Researching possible materials to use, shaping methods, jointing methods and finishes, and then choosing which you are going to use.

8. Textbook or computer program.

9. Weight, rigidity, hardness, toughness, texture, colour, opacity, malleability, ductility, conductivity.

10. A **prototype** is the product made at the end of a project, using the correct sizes, materials, joints and finishes. The prototype should work. A **model** is often made to a proportional size, with cheaper materials. It doesn't always need to work.

11. Dimensions, proportions, colour schemes, mechanical systems, feature positions, shape, attractiveness, stability.

12. Paper, card, cardboard, MDF, plywood, balsa wood, rigid foam, polymorph plastic, wire, welding rod, match sticks, lollipop sticks, clear plastic sheet, drinking straws, clay.

13. Glue gun adhesive, double sided tape, split pins, blutack, PVA, velcro, pritt-stick.

14. Orthographic working drawing Rendered pictorial drawing

15. It should include all the information required to make the product.

16. Information table Flowchart.

17. The 'Quality Check' column is very important, because if the checks are not planned they will be forgotten and the product parts are unlikely to fit together well.

18. Drilling holes before the item is bent and difficult to hold.

19. Designer specification.

20. Market Testing To support your own thoughts about the product, it is a good idea to create a questionnaire and ask your family and friends to give their opinions by testing your prototype.



## WORKSHEET 11a

1. One year's growth of wood is shown as an annual ring.
2. By counting the number of annual rings.
3. The five main features are: bark, growth cells, annual rings, heartwood, sapwood.
4. Harder, darker and drier, the best wood.
5. To be useful, the wood has to be converted from a tree trunk to planks. This is done by sawing through the tree trunk. There are two common methods of sawing.
- 6.

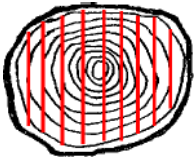

Through and through  
Conversion



Quarter sawn  
Conversion

**Through and through** - a quick cheap method, but produces planks that are likely to warp.

**Quarter Sawn** - a more costly method that produces more waste, but the planks produced are less likely to warp.

7. When the wood is cut into planks it is still very wet from the water taking the minerals from the roots to the leaves. If the planks dry quickly the wood splits and warps and becomes useless. To dry the wood slowly it is stacked in large drying ovens called **kilns**. The drying programme takes four or five weeks.

8.

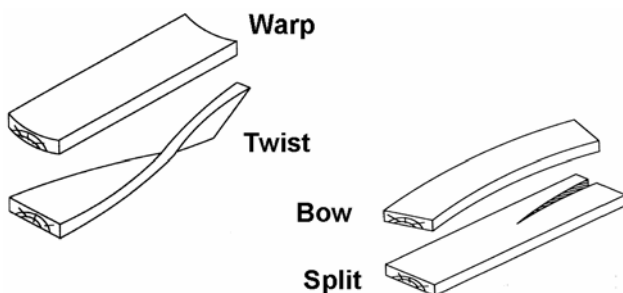

9. Less than 10%

10. It is best stored flat or vertically upright, so that it does not bend because of its own weight.

## WORKSHEET 11c

1. Hardwoods - deciduous. Softwoods - coniferous.
2. Made from the waste wood left over from conversion.
3. Planed All Round, Planed Both Sides.
4. 47mm x 22mm

5. A plank is between 225 and 375mm wide and 50mm or more thick. A strip is between 25 and 100mm wide and between 9 and 25mm thick.

6. Cedar or protected Scots Pine.

7. Beech

8. It is made from thin sheets of wood (veneers), glued together with the grain direction at 90° to the one next to it. They always have an odd number of layers 3,5,7 etc. to reduce warping.

9. Blockboard

10. It is made from small chips of waste wood.

## WORKSHEET 12

1.

1. Look along the length of the strip of wood and see if it is warped, bowed or twisted.

2. Check the ends to see if there are any splits.

3. Check for knot holes or loose knots.

4. Check to see if there are too many knots, because they may make the wood hard to plane smooth.

5. Check for small holes made by insects such as woodworm.

2. 3mm

3. Allow 1162mm or 1165mm (3mm added at one end or both ends).

4. Marking gauge.

5. Check that the edge is at right angles with a try square.

## WORKSHEET 13

1. Mark out the shape in a corner of the sheet.

2. By the loop mark on the face side and the tick mark on the face edge.

3.

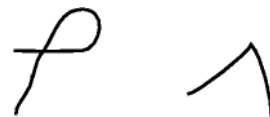

4. With the handle touching the face edge.

5. A marking gauge.

6. It cannot be rubbed out.

7. Dividers have points on both legs.

8. A marking knife.

## WORKSHEET 14a

1. Each tooth of the saw is alternately bent to the right and the left of centre. This is to stop the blade from jamming in the cut. The width of the cut is called the **kerf**.

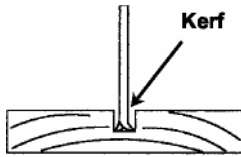

2. Diagram of a bench hook (sawing board).
3. Use trestles (sawing horses)
4. A Tenon Saw, it has a rigid blade designed for cutting joints.
5. A Panel Saw, because you can complete long straight cuts with it.
6. Coping Saw
7. Teeth per inch.
8. Set the frame at right angles to the blade.

## WORKSHEET 14c

1. Jack plane and Smoothing plane.
2. So that the plane produces tissue thin shavings.
3. Height adjustment screw.
4. Level adjustment lever.
5. 0.5mm or less.
6. To check the direction, the **side** of the piece of wood should be looked at, not the top surface being planed. Look at the grain approaching the top surface. Plane in the same direction.
7. Either direction.
8. The wood splits.
9. Plane half way from both ends.
10. Clamp an extra piece of waste wood to the edge of the board or chamfer the corners of the board.

## WORKSHEET 14d

1.

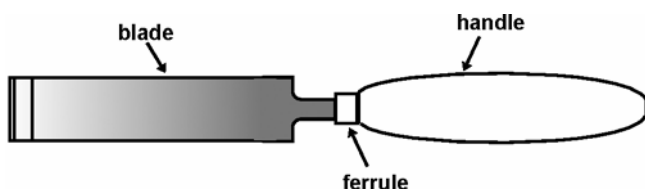

2. Ash or Polycarbonate
3. It stops the wooden handle from splitting.
4. They allow the chisel to get into corners.
5. Keep both hands behind the blade.
6. Tool steel

7. For cutting the mortise of a mortise and tenon joint.
8. To absorb some of the shock.
9. The gouge has a curved blade the firmer chisel has a flat blade.
10. To cut shallow depressions in wood.

## WORKSHEET 14e

1. Holding the drill bit.
2. HSS High Speed Steel.
3. Countersunk hole      Screwhead level with surface

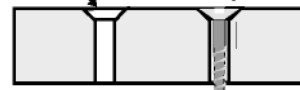

4.

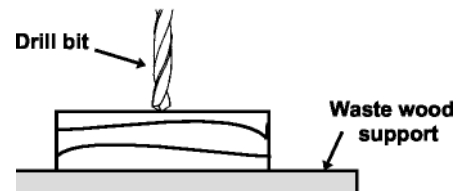

5. This drill is so named because the main parts can be made to slide up and down the central pillar.
6. When drilling a larger hole with a power drill.
7. When using a flatbit or hole saw, only cut the hole until the point of the flatbit, or the guide bit of the hole saw, break through the other side. Then turn the wood over and using the break-through hole as a guide, cut the second half of the hole.
8. Hole saw. Drill bits are not normally made that large.

## WORKSHEET 14f

1. Never use a power tool until you have received instruction on how to use it safely.
2. If your finger touches the revolving disc you will receive a very painful graze.
3. A good rule is that when the wood is touching the disc it should be covering the slide slot in the table. If it doesn't, it is too short.
4. To stop the disc from clogging.
5. If a finger touches the blade lightly, the flesh tends to move up and down with the blade and is not cut by it.
6. Position the hold down bar no more than 0.5mm above the material being cut.
7. Stop the power lead from trailing across the floor of the workshop.

## WORKSHEET 15c

1. Side grain to side grain.
2. A butt joint is end grain to side grain, a cut joint allows for side grain to side grain contact.
3. Two from: butt joint, lap joint, comb joint, mitre joint, dowel joint, dovetail joint. Both sketched.
4. Two from: through housing, dovetail housing, stopped housing. Both sketched.
5. A wooden strip glued on the inside or dovetail pinning. (Sketched)
6. Triangular pieces of thin wood glued into saw cuts across the joint. (Sketched)
7. Lining up the holes.
8. Dovetail joint. (Sketched)
9. Use a Cross halving.
10. One from through housing, dovetail housing, or stopped housing. (Sketched).

## WORKSHEET 17

1. Permanent jointing.
2. The solvent needs to evaporate (dry) before the adhesive works. The time this takes is called the setting time.
3. Most wood adhesives are made up of solid particles of glue being dissolved in a solvent (water or spirit).
4. The glue soaks into the pores of the wood and then sets like lots of little fingers grabbing onto the wood on both sides.
5. It is very important that the surfaces to be glued are freshly cleaned with glass paper to remove any dirt or oily residue left by touching the surface with your fingers.
6. Using a clamp to hold the two halves of a joint together firmly, helps to force glue into the pores of the wood. Cramping also holds the joint still while the glue is setting.
7. Varnish the wood before you glue the parts together, the glue will not stain varnished wood.
8. After normal glueing, mix sawdust of the same wood with the glue to make a paste and use this to fill the gap.
9. Synthetic Resin (Cascamite) because it is waterproof.
10. Use it in a well ventilated area and do not sniff it.

## WORKSHEET 18b

1. Friction between the nail shaft and the surrounding wood.
2. Galvanised mild steel.
3. A pin punch is used with a hammer to drive the head of the pin below the wood surface. The hole above the pin head can then be filled with a wood.
4. Place the nail at least nine times its diameter from the end of the wood.
5. Sketch of claw hammer. Designed for hitting nails into wood and for removing bent nails from wood.
6. Hold the pin in a piece of card.
7. The chipboard screw has thread all the way up the shaft and it has two threads (spirals) wrapped around each other.

8.

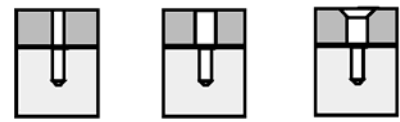

9.

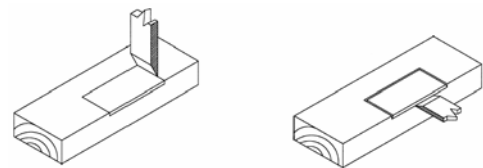

10. Knock down joint.

## WORKSHEET 19

1. A laminate is made up of layers of veneers (thin sheets of natural wood) glued, one on top of another. Unlike plywood, the grain of each sheet is normally lined up in the same direction.
2. For laminated wood to bend the layers would need to slide over each other the adhesive prevents this from happening.
3. A laminated strip is tougher than solid wood because a crack that starts on one side of the strip is stopped by the glue line and does not go all the way through.

4.

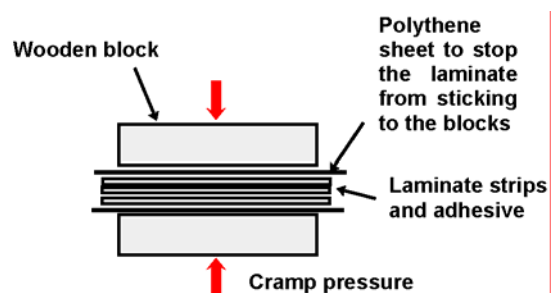

## WORKSHEET 19 (CONT.)

5.

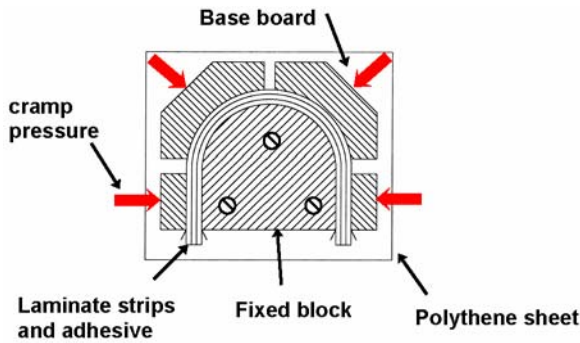

6. To stop the laminate from sticking to the blocks.

## WORKSHEET 20b

1. To stop wood from absorbing moisture, so that it is less likely to become stained and warp. To protect against rot and insect attack. To improve the appearance of the wood's surface.

2. Planing with the blade set to provide tissue-thin shavings.

3. 00

4. Wrap the glasspaper around a sanding block. Always sand backwards and forwards in the direction of the grain.

5. Stain (colouring) is used to change the colour of light woods to make them more interesting or to blend in with darker woods.

6. Matt, satin and gloss.

7.

i) Apply the first coat thinly and let it set fully. This coat soaks into the pores of the wood and then sets. The wood is now sealed.

ii) Use a fine grade of glass paper to lightly sand the surface because the first coat tends to make the surface rough as it sets.

iii) Apply the second coat also thinly, check for any runs or drips and let it set to a smooth finish.

8. It does not crack or peel off.

9.

1. A primer coat. A primer is a paint that sets quickly and seals the pores in the wood.

2. An undercoat coat. Undercoat paint contains a lot of pigment (colour) to stop the original surface showing through.

3. A gloss top coat. Gloss paint contains less pigment and more clear varnish to provide the shine. If the paint also contains polyurethane it will have a tough, scratch resistant finish.

10. Acrylic gloss. A water based paint that only requires a primer and top coat. The gloss is not as shiny, or the finish as scratch resistant as a polyurethane paint. Emulsion A water based paint that often contains vinyl to make it more water resistant and easier to wipe clean. Normally only two coats are required, the first coat seals the wood like a primer. The finish can be matt or satin only, gloss is not an option.

## WORKSHEET 21

1.

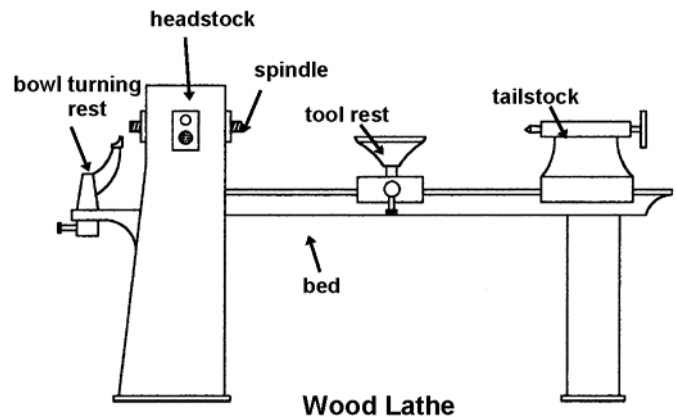

2. So that they can be held safely and give good leverage.

3. It is cut into an octagonal shape.

4. The outside shape before the hollowing.

5. The wood should be prepared by marking out an octagon on both ends and then planing the sides. At one end a saw cut should be made to allow the teeth of the drive dog to dig into the wood. (sketches req.).

6.

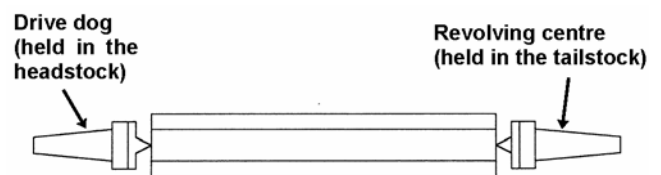

7.

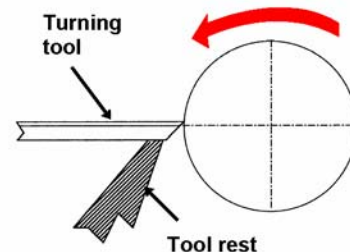

8. Never attempt to use a lathe until you have received instruction from your teacher. Always wear goggles!

**WORKSHEET 24b**

1. Ferrous - metals that contain iron and are affected by magnetism (apart from stainless steel).

Non-ferrous - metals that do not contain iron and are not effected by magnetism.

2. Alloys - metals made up from a mixture of elements, e.g. Copper + zinc (brass) or lead + tin (solder)

3. In steel the rust layer is loose and can fall away; this exposes new atoms that will combine with oxygen to form new rust. In non-ferrous metals the oxide layer is dense and does not fall away; this creates a barrier to the oxygen in the air and new corrosion occurs very slowly. The layer is called tarnish.

4. Mild steel contains contains 0.15 - 0.35% carbon, and is ductile, malleable and tough. Tool steel contains 0.8 - 1.5% carbon, and is very hard, rather brittle and is difficult to cut.

5. It does not rust.

6. It is nearly as strong as mild steel but only only third the weight.

7. It is a good conductor of heat and has a high melting point.

8. It is not rigid enough to be used for taps.

9. It is wear resistant.

10. It is weak and soft.

**WORKSHEET 25**

1. Scribes, scribing blocks, dividers and odd-leg callipers.

2. Using Engineer's Blue

3. Use a centre punch to make an indent for the leg to sit in.

4. Odd-leg Callipers.

5. For running along the edge of the metal.

6. So lines can be scratched at different heights.

7. Because it can do at least three different jobs.

8.

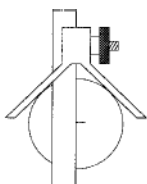

9.

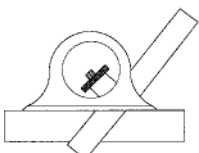

10. A sketch showing the combination square set up like an engineers square.

**WORKSHEET 26a**

1. To take different lengths of blade.

2. 32 TPI or 24 TPI

3. So that the teeth don't jam.

4.

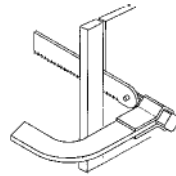

5. A Tension file.

6.

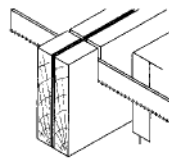

7.

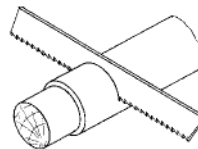

8. To stop the saw blade from sliding over the metal when starting a cut, use a triangular file to file a groove on the waste side of the line. The saw teeth should fit into the groove.

**WORKSHEET 26b**

1. To push fit into the handle.

2. Sketches of cross sections of flat, square, triangular, round, half-round, knife.

3. Bastard to get rid of most of the waste quickly. Second cut to leave a reasonably smooth finish. Smooth or dead smooth to provide a very smooth finish.

4.



5. When filing a long edge, push the file forwards and slide it sideways at the same time.

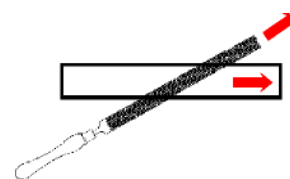

6. Drawfiling (Sketched)



**WORKSHEET 26c**

1. To hold smaller diameter jobber drill bits.
2. The larger diameter bits have a tapered shank and are held directly in the pillar drill spindle. The thin part at the end locks into the spindle and cannot slip under pressure, like a straight shank could in a chuck.
3. For holes in metal of 8mm diameter or larger, it is better to use a smaller drill bit first (4 or 5mm dia.). The smaller drill is less likely to wander off the centre punch mark. It also provides a hole that can guide (pilot) the larger drill.
4. Set the pillar drill's depth stop, so that the drill cannot drill beyond a depth of 10mm.
5. Use cone bit.
6. Illustration of a hand vice with the metal supported on a block of wood.

**WORKSHEET 26d**

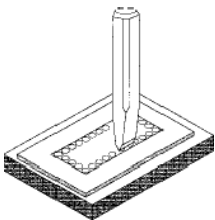
1. High Carbon Steel
  2. A sketch of chain drilled holes.
  3. The chisel is hit with a hammer to cut between the holes until the inside is cut free. The edges are then filed with a safe-edge file.
- 
4. Chiselling is faster than filing and the top of the vice can be used as a guide.
  5. When cutting along a curved line.
  6. One side of the cut curves away from the other side.
  7. They can be used for both straight and curved cuts.

**WORKSHEET 26e**

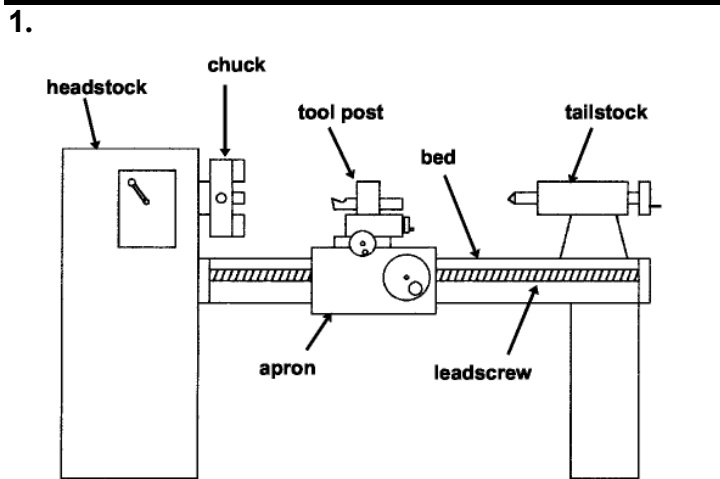

2. HSS or tool steel with a tungsten carbide tip.
3. To 100th of a millimetre.
4. Illustration of turning down, facing off, parting off, thread cutting.
5. Enlarging a hole by cutting away the inside wall.
6. The chuck revolves the work, while the drill bit is held still in the tailstock.
7. Use a centre drill.

**WORKSHEET 27a**

1. Annealing - by heating the metal to a dull red. The metal is now more malleable, so it will not split when it is hit with the mallet. The surface will now be black (burnt tarnish) and this needs to be cleaned off before hollowing. Either emery cloth can be used to clean it, or the still warm disc can be placed into a bath of dilute sulphuric acid.
2. Forming block or sandbag and a bossing mallet.

3.



4. Sinking gives a lip around the edge.
5. Sketches of a bowl without a lip and one with a lip.
6. a) to remove any unwanted bumps and to correct the overall shape.  
b) to harden the metal and make it more rigid.
7. The bowl is placed over a **Mushroom Stake**. Starting in the centre, the bowl is revolved one space after each blow. The blows should spiral outwards to the edge.

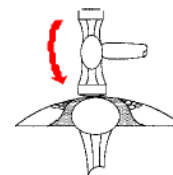

**WORKSHEET 27b**

1. Up to 1.5 mm.
2. The net should be dimensioned for a box of 200x150x20mm.

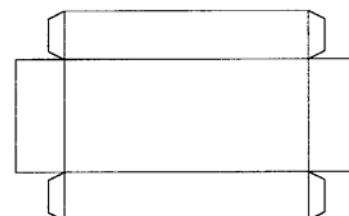

**WORKSHEET 27b (Cont.)**

3. It is less costly than metal if an error is made.
4. By folding over to make a safe edge.
5. Folding bars can handle sheet metal of larger size than a vice on its own.
6. By using a block of wood a folding jig. It has to be the same size as the base but thicker than the box height.
7. Use wooden striker, hit with a mallet.
8. For bending curves, a machine that has three adjustable rollers is used. The tightness of the curve can be controlled by altering the position of each roller.



**WORKSHEET 27d**

1. When it is hit it is squashed and becomes more dense. Also, a shaped product will have the 'grain' (layers of crystals) flow around the shape.
- 2.

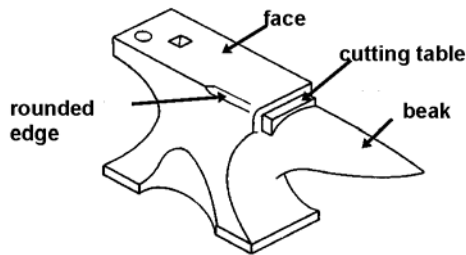

3. To grip the hot metal firmly.
- 4.

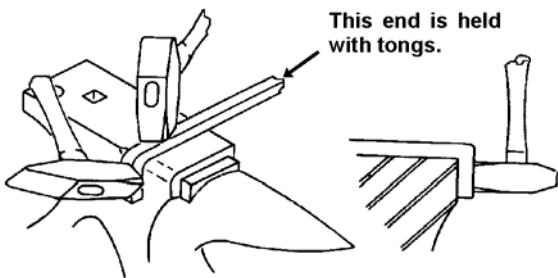

5. 1. Hold the bar at a slight angle to the anvil face and hit on one side, the anvil face flattens the other side at the same time.
2. Turn the bar 90° and hit again to make the point square in shape.



3. Hit each corner of the square shape to turn it into an octagonal shape

4. Continue turning the bar and hitting the corners until the point is round in shape.



6. Upsetting is the term given to the process of thickening the metal. This is useful for maintaining strength when drilling a hole.

7. Heat the bar to a bright red and then grip it the vice and slide on a special twisting tool, or use a large tap wrench. Twist the metal while it is still red hot. Twisting will only occur between the vice and the wrench.

- 8.

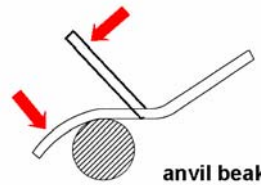
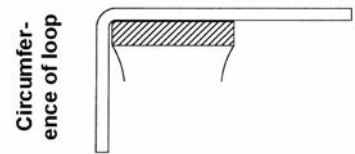

1. Start the curve by hammering it over the anvil beak.

2. Work towards the end of the metal to complete the curving.

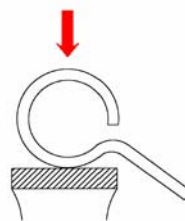

3. Close the loop by tapping it with a hammer on top of the anvil face.



- 9.

An 'S' scroll

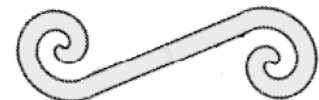

10. The metal is heated to bright red in a forge.

**WORKSHEET 28b**

1. The pattern should be tapered so that it can be taken out of the sand without dislodging any sand grains. The taper is known as the Draft.

2. Internal corners need to have a fillet to stop cracks appearing during cooling.

3. A pattern that, because of its shape, would dislodge sand when it was removed needs to be split into two or more sections. The two halves are held together with dowels.

## WORKSHEET 28b (CONT.)

4. So that the halves can be separated when the pattern needs to be removed.

5. A) the drag is turned upside down and put on the base board. The pattern is placed in the middle. Moulding sand, made damp with oil or water is sieved over the pattern until the pattern is covered. B) The rest of the sand is then shovelled in and then rammed with a rammer until it is packed tightly. The surface is then levelled by scraping a metal strip across (strickling).

C) The drag is turned the right way up and the cope is then placed on top. The top half of the pattern is added and also the sprue pins are positioned. Sand is then added and rammed to fill the cope.

D) The cope is now lifted off and the top half of the pattern and the sprue pins are removed. Channels called gates are cut between the sprue pin holes and the pattern to allow the molten metal to flow into the mould cavity.

E) A wood screw is screwed into the pattern and it is tapped from side to side to release the pattern from the sides of the sand mould. The pattern is then carefully lifted vertically from the mould.

F) The cope is placed back on the drag. A hollow basin shape (pouring basin) is cut into the sprue hole that the metal will flow into (runner). A thin metal rod is pushed into the sand to create narrow holes that will allow air to escape when the metal is poured.

6. To allow trapped air to escape.

7. The casting will come free with its gates and sprues attached, these will have to be removed by sawing them off and filing down the stumps.

8. To provide a hole in the casting.

9. Extra pieces are added to provide hollows in the mould that will hold the core in place. These are called core prints.

10. The cores sit in the core prints.

## WORKSHEET 29b

1. Cutting an internal thread into the side of a hole is known as 'tapping the hole'.

2. On a tap or die. The 'M' stands for metric. The 10 is the thread diameter in mm. The 1.5 is the size of the pitch in mm.

3. The pitch is the distance between the tip of one tooth and the tip of the next tooth, in mm.

4. This is a hole that is smaller in diameter than the thread diameter (nominal size), so that the thread can be cut into its side.

5. A blind hole.

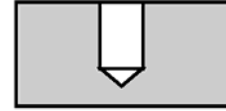

6. Taper tap - tapers for ten threads. Second tap - tapers for five threads. Plug tap - tapers for 1.25 threads.

7.

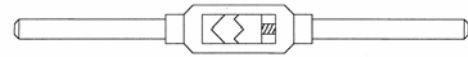

8. A die held in a die stock.

9. The centre screw is tightened to open the die. The outer screws are tightened to close the die.

10. Make sure that the die stock is at right angles to the rod to stop a 'drunken' thread being cut.

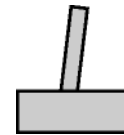

Effect of drunken thread

## WORKSHEET 29c

1. Hammer the rivet shank into a rough mushroom shape using the Ball Peen part of the hammer head.

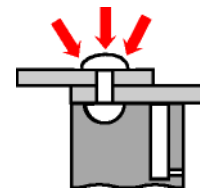

2. The set part is used to go over the shank of the rivet and push the two pieces of metal to be joined together. The snap part is used to support the rivet head while the shank is being formed and also to round off and smooth the rough shaped head at the shank end.

3. To make sure the holes line up, mark out and drill one pair of holes only. Rivet them together and then line up the metal sheets. The remaining holes can then be marked out and drilled.

4. The pin is pulled by jaws in the gun. The pin head squeezes into the tube of the rivet. The pin then breaks away and leaves the head behind.

## WORKSHEET 29d

1. Tin and Lead.
2. 183° to 250°C
3. Dirt and grease will stop the solder from soaking into the surface of the metals to be joined.
4. To stop the component from overheating. The heat goes into the sink to heat it up instead of travelling further up the wire and heating the component.
5. The solder remains liquid until the surface goes dull.
- 6.

1. When the metal is heated up for soldering it stops an oxide layer forming (tarnish). Molten solder must be able to soak into the surfaces of the metal sheets being joined, to make a strong joint.

2. It breaks down the surface tension of the molten solder to allow it flow in between the metal sheets.

7. Acid - a clear liquid that when applied will clean the surface of the sheet metal by dissolving any oxide layer or grease, before soldering starts. This flux must be washed away with water as soon as the joint has been soldered, otherwise it will weaken the joint. Passive - a brown resin that looks like grease. This does not dissolve any old oxide layers, so surfaces need to be cleaned with emery cloth first. It does not need to be washed away at the end.

8.

1. Apply flux to both surfaces

2. Melt solder onto the hot tip (tinning the iron)

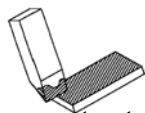
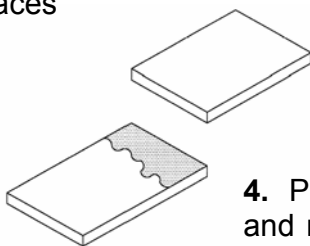

4. Place the parts together and rub the hot iron over the joint to re-melt the solder. Then let it cool and set.

3. Apply solder to both fluxed surfaces

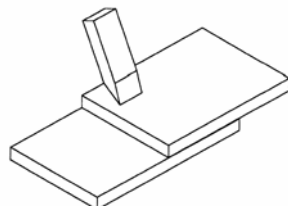
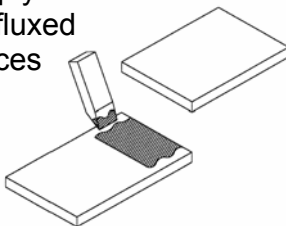

## WORKSHEET 29e

1. Spelter is brass (copper & zinc) and melts at 870°C.
2. The force of the blowtorch flame can move the metal parts to be soldered.
3. So that the loops can be twisted to tighten the wire.
4. Borax. The powder is mixed with water to make a paste.
- 5.

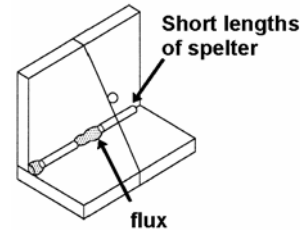

6. Copper, zinc and silver.

7. Easy flow - melts between 625°C and 690°C  
Medium - melts between 690°C and 725°C  
Hard - melts between 725°C and 800°C

8. If one type of solder only was used, then the solder put on the seam would re-melt and the joint would spring open when the base was being heated for joining. When the three grades are used, as shown in the diagram, each joint melts at a lower temperature than the last, so earlier joints stay set.

## WORKSHEET 29f

1. Gas - using an oxyacetylene gas flame  
Arc - using an electric spark  
Resistance - using an electric current.

2. Acetylene and Oxygen.

3. The filler rod is used to build up the joint and to replace the metal that has evaporated.

4. The flame is moved forward in a series of small circular movements to heat a wider area than the diameter of the flame.

5. If the ends are not tacked the pieces will warp in the heat and the joint will separate.

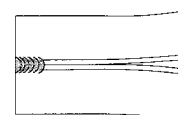

## WORKSHEET 29f (CONT.)

6. The joint metal and the filler rod are both connected to an electric circuit. When the rod is held a short distance away from the joint, sparks fly between the two. The temperature of the sparks is so high that both the end of the rod and the joint metal melt and form a weld pool.

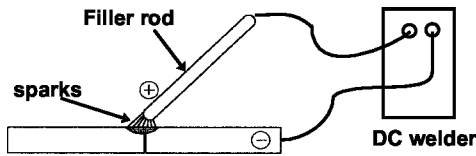

7. A passing a current through the sheets of metal heats them up where they touch each other, because this is where there is most resistance.

8. Illustration of Squeeze time, Weld time, Hold time and Release.

## WORKSHEET 30

1. Work Hardening When metal is bent or shaped by hitting with a mallet, the area being reshaped becomes harder and more brittle.

2. Annealing is the process of heating metal to soften it and remove the brittleness.

3. Put soap on the surface and heat with a blowtorch until the soap turns black.

4. Heat to cherry red and then let it cool slowly, buried in sand.

5. It is hardened by heating to bright red and then cooling it quickly by plunging it into room temperature water.

6. It is now very hard, but unfortunately also very brittle, too brittle to use without it breaking. It needs to be softened a little to reduce the brittleness, this is done by the process of tempering.

7. A) Clean the area to be tempered. B) Heat gently until the correct colour appears and moves to the blade. C) Plunge into room temperature water and swirl it around.

8. It is case hardened.

9. Any cracks that start in the hard, brittle outer case are stopped by the soft core.

10. At certain temperatures, colours appear on the surface that only appear at that particular temperature. So the type of colour showing tells you what the temperature of the surface is.

## WORKSHEET 31

1. Wrap emery cloth around a file and rub it up and down in one direction.

2. It can catch your clothing or a rag if you are holding it and drag your hand into the machine.

3. It is less likely to flake off.

4. Lacquered.

5.

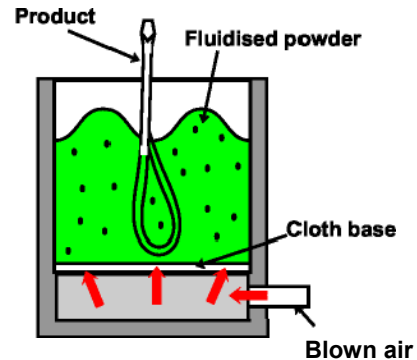

6. Enamelling.

## WORKSHEET 32b

1. Piercing is when a press is used to cut holes of any shape out of a sheet of metal. The part cut out is waste. Blanking is when a press is used to cut out a shape that is to be kept and used. The sheet of metal that it has been cut from is the waste.

2.

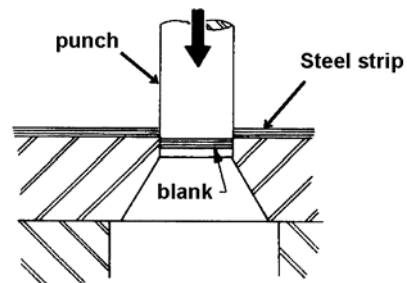

3.

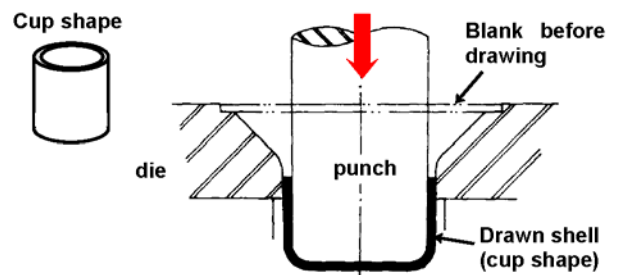

4. Illustrations of extrusion and rolling.

5. An ingot of metal is heated until it is soft. A hydraulic ram then forces the metal through a shaped hole in a die.

6. Die casting. Because the moulds are permanent and do not need to be made each time.

7. Lost wax casting.



## WORKSHEET 33

1. Thermoplastics - can be reshaped by heating. They will try and return to their original shape if re-heated. Thermosetting Plastics - cannot be reshaped by heating and can withstand higher temperatures than thermoplastics.
2. All modern plastics are made mainly from oil, coal and extracts from plants. They are **synthetic** (not natural - manmade) and come in hundreds of types, each with their own set of properties. Many have been made to order by materials scientists.
3. Most property changes are made by adding additives to the basic plastic.
4. To protect it from the effects of ultra violet light and stop it becoming brittle.
5. Polyvinyl chloride (PVC) because it is rigid, quite hard, has good chemical resistance and is tough.
6. Expanded polystyrene because it is very light in weight.
7. Acrylic, because it is rigid, hard, very durable outside and polishes to a high shine.
8. It is tough, resists wear, has good chemical resistance.
9. ABS because it is very tough, scratch resistant and has good chemical resistance.
10. Urea formaldehyde, because it is rigid, hard, strong, heat resistant, does not bend when heated.

## WORKSHEET 34

1. To protect the surfaces from accidental scratching.
2. Spirit based markers.
3. By marking out the centre point on a double layer of masking tape stuck in the correct position.
4. To allow a pencil to be used for marking out a curved line and a marking gauge to scratch a line.
5. Show that there is less waste when a shape is marked out in a corner and not in the centre of a sheet.

## WORKSHEET 35a

1.
  1. Hard, rigid plastics such as Acrylic and Polystyrene can crack easily if they are not well supported.
  2. Power saws tend to create so much friction heat that the cut plastic softens and welds itself back together again behind the blade.
2. It provides support all around the saw blade.
3. If the teeth pointed upwards the plastic would rise with saw with no support.

4. The tape takes away enough heat from the plastic to stop it welding together behind the blade.

5.

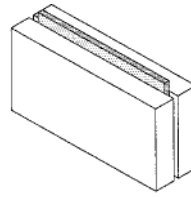

6.

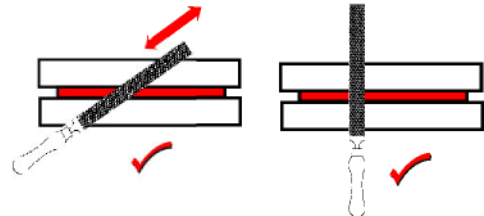

7. A standard drill will catch the plastic as it breaks through the bottom of the hole and cause cracking around the hole.

8. Use pilot holes. First drill the hole with a 4mm drill and then redrill with a 6mm drill and continue using drills that are 2 or 3mm larger in diameter until the correct size is reached.

## WORKSHEET 35c

1. If the plastic sheet is re-heated then it will try to return to its original shape of a flat sheet. This property is known as plastic memory.

2.

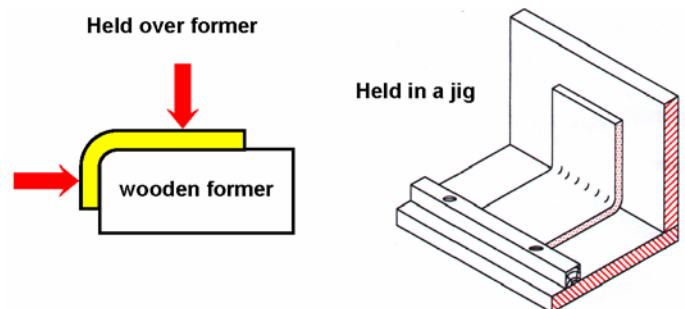

3. A) Placing a shape onto MDF. B) Clamp a sheet of soft heated acrylic between the shape and sheet of MDF. Let it cool. C) Remove the top surface to half the depth of the indent with a file. D) Re-heat in an oven until the acrylic returns to its original thickness.

4. A description of press forming.

5. So that the formed plastic can be removed from the mould easily.

6.

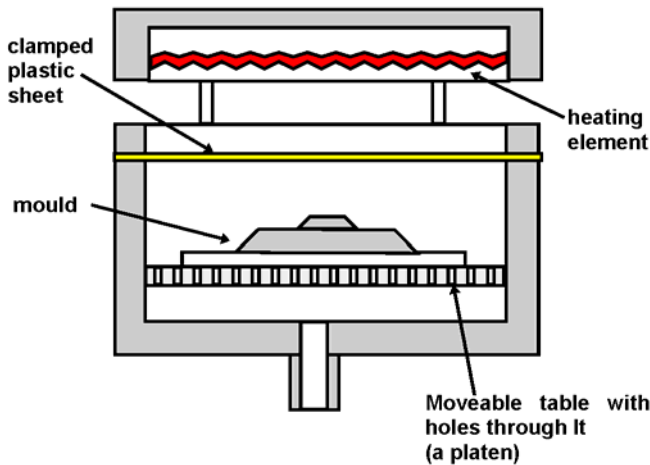

7. Using a profile router.

8. Blow moulding, Vacuum forming, Press forming.

9. Blow moulding.

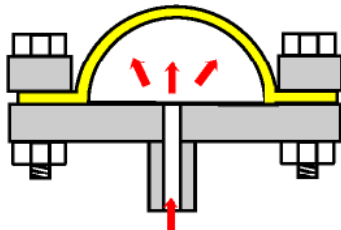
**WORKSHEET 35d**

1. Injection moulding (possible diagram)

2. Thermoset plastics cannot be softened by re-heating, so any plastic left in the machine would block the nozzle for good.

3.

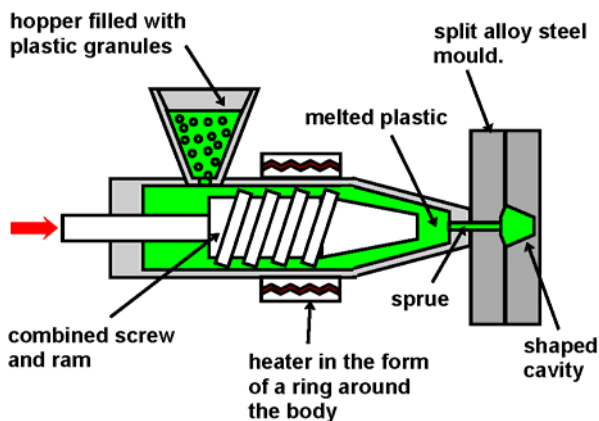

4. A) A layer of release agent is applied to the inner surface to stop the new GRP from sticking to the mould. The release agent can be in wax form.

B) A thick layer of coloured gellcoat resin is painted over the release agent.

C) A sheet of glassfibre is laid by hand over the dry but sticky gell coat layer.

D) Polyester resin, the same colour as the gellcoat, is stippled onto the glassfibre until it is covered with resin. This is then allowed to set before the hull is taken out of the mould.

**WORKSHEET 36**

1. A diagram of an 'Octaclip' in use.

2. Any cement spillage or seepage from the joint will permanently mark the surface.

3. Cements are spirit based and can cause major problems if sniffed.

4. Where large areas of contact are involved.

5. A heated wheel, run over two sheets, one on top of the other, will heat-weld the two sheets together along the line of travel.

**WORKSHEET 37**

1. Ultra-violet light can cause some plastics to become brittle and shatter easily.

2. Rub the edge longways over a board covered with wet & dry paper.

3. Wrap wet & dry paper around a half round file and drawfile along the edge of the plastic.

4. To stop the plastic from over heating and burning, move the plastic towards you once and let it cool for a few seconds before making a second pass.

5. Scratches on the face of the plastic can be removed by rubbing the scratched area with metal polish and a rag.

**WORKSHEET 39b**

1. They do not rot or corrode. They are light in weight. They are easy to use in mass production. They come in a vast range of colours. They can be clear and transparent. Lubrication is not required for moving parts. Moving parts work quietly.

2. The exact amount of plastic powder or granules is put into the mould so that there is no waste to clog up the process.

3. Ejector pins.

4. Extrusion, because long lengths can be made.

5.

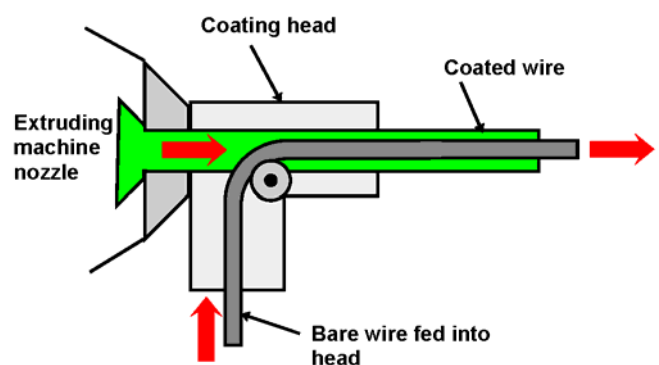

**WORKSHEET 39b (CONT.)**

6.

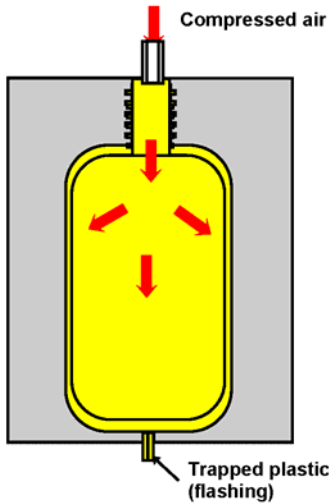

7. So that the inside walls of the mould are coated evenly.

**WORKSHEET 40**

1. A smart material is a material that can be controlled. It can be made to change its colour, size or shape and be returned to its original form at will.

2. The control input can be changing the temperature of the material, applying an electric current through the material or by applying pressure to the material.

3. Shape Memory Alloys & Shape Memory Plastics.

4. Nickel and Titanium.

5.

At room temperature the split rivet is in its open position.

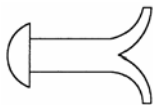

When cooled to below freezing, the rivet becomes straight.



When cold and straight the rivet is placed through the hole and is allowed to heat up to room temperature. The rivet then opens up inside the tube and holds the sheet and tube firmly together.

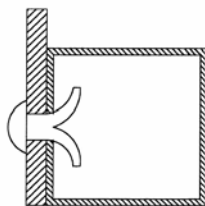

6.

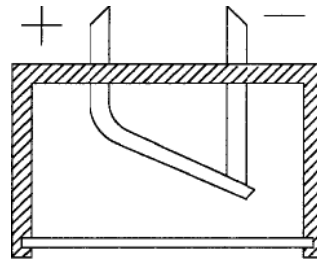

The diagram shows a detector for a fire alarm sprinkler system. When a fire raises the temperature, the positive (+) contact straightens and breaks the circuit, this will trigger the sprinklers.

7.



The diagram shows an artificial hip joint. When it is cooled the teeth lie flat and allow it to be inserted into the top of the thighbone.



When the temperature of the joint rises to that of the body, the teeth curve out and grip the inside of the hole in the bone and stop the joint from moving.

8.

Glasses frames that remember their shape are made from a SMA. If the glasses are sat upon and the frames are twisted, the alloy remembers its room temperature shape and returns to it.

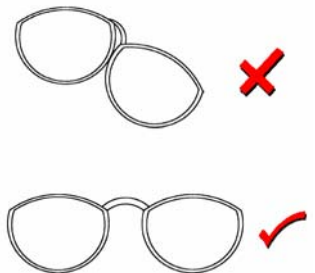

<b>Area to Revise</b>	<b>Revised</b>
Material Properties	
Woods	
Manufactured Boards	
Metals	
Plastics	
Composite Materials	
Smart Materials	
Nanomaterials	
Sustainability of Materials	
Knock Down Fittings and Fixings	
Mechanical Methods of Joining Materials	
Adhesives	
Surface Preparation	
Applied Finishes	

## **Mechanical Properties:**

**Mechanical Properties** are linked to the way they react to the applied force. Some Mechanical Properties may deform in temporary way, while for different materials it is more permanent. The strength of a material is its ability to hold (withstand) an applying or applied force devoid (withstand) of breaking or permanently being bent. Different types of materials can have different types of strength dependent on how they resist the forces being applied.

### **Types of strength:**

**Bending** is where you have the ability to withstand forces that are attempting to bend.

**Compression** is the resistance to forces that are trying to crush or shorten.

**Shear** is where the resistance to forces sliding in opposite directions.

**Tension** is where the resistance to forces pulling in opposite directions.

**Torsion** is where you have the ability to withstand twisting forces.

## **Physical Properties:**

Most of the physical properties of materials are unchanged by the applying forces or by the intensity of heat, as seen in several plastics. Fusibility is where you have the ability to alter the materials into a liquid material at certain temperature. This is extremely important feature in which materials are needed to be melted to carry out a Fabrication process such as soldering, welding, also forming processes such as moulding and casting.

Electrical Conductivity is the capability to tolerate electricity to pass through a material. Good electrical conductivity is seen in most metals, mainly gold, silver and copper. Great electrical insulators are woods ceramics and plastics. Thermal Conductivity is the capability to tolerate heat to pass through a material. Metals have a great thermal conductivity where as non-metallic materials have poor conductivity they are referred to as insulators.





## Hardwood

Hardwoods grown in the uk tend to be from Broad-leaved, deciduous trees that lose their leaves each autumn. Beech, oak and ash are examples of hardwood trees grown in the uk. Hardwoods grown in the rainforest include teak and mahogany.

Hardwood: is also timber that tends to be from growing , broad-leaved trees.

Examples: Beech, Oak, Ash, Mahogany, Teak.



## Softwood

Softwoods come from conifers, which are evergreen trees. Most conifers keep their needles throughout the year. Large amounts of softwoods such as pine and cedar are imported into the uk from Scandinavian countries, while the uk produces about 10 per cent of its own softwood in plantation. Softwood: timber from quick growing conifers

Examples: pine, Cedar.



**Manufactured Boards** are made by changing logs into a variety of forms and then gluing them together to create sheet materials. The reason for doing this process is to produce large, flat sheets of timber that are stronger and more stable than conventional wide boards of softwood and hardwood. This process often uses more of the trees and therefore can be used to produce large boards of timber more economically.

Examples: plywood, MDF, chip board

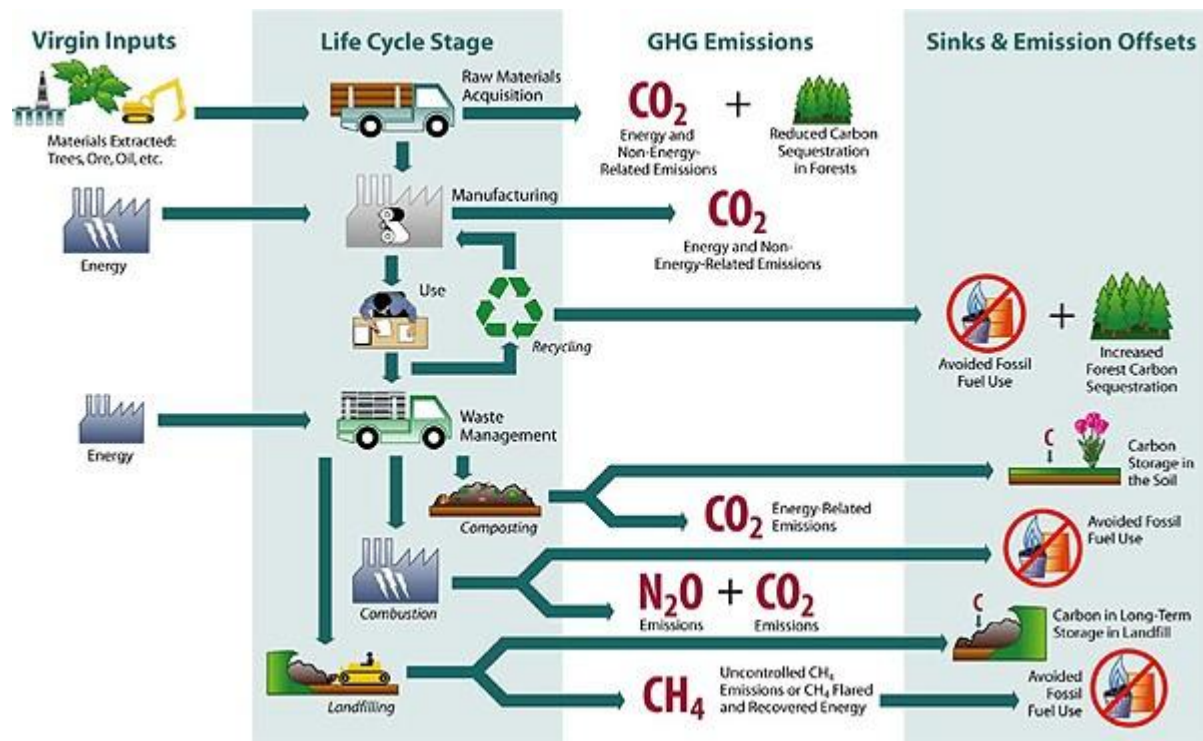

**Life cycle of Wood:** first of all the trees are planted and then the tree is cut then transported by road rail or river. The tree is converted to useful sizes then transported to a factory then it is product manufactured then sold to the retailer which then the retailer sells to the user and then the user after they have used it recycle it back to the place where the product is manufactured or composted or gets left on a landfill.

**Environmental consequences:** when the wood is transported the transport used causes pollution and where the tree is converted into useful sizes will let off harmful fuels and gasses.



**Ferrous Metals** are metals that contains iron and varying amounts of carbon. They are normally magnetic.

Examples: stainless steel



**Non Ferrous Metals** are metals that do not contain iron.

Examples: Aluminium, Copper, Zinc, Gold, Lead and Tin



**Alloys** are a combination of two or more metals

Examples: Brass, Steel, Bronze and Pewter

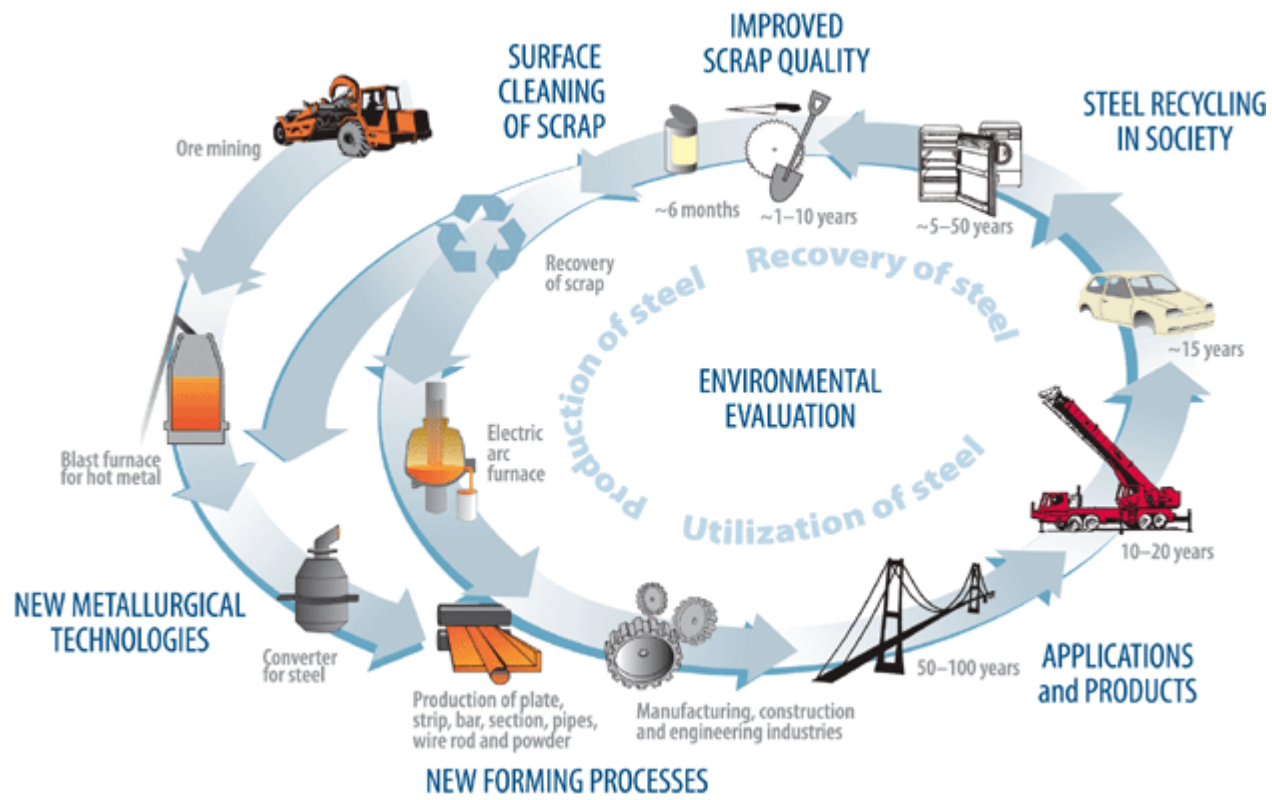

**Life cycle of Metals:** The ore is dug from the ground and then transported to where the ore is converted to metal using huge amounts of energy then the product is manufactured and then sent to the retailer which is then sold to the user and then the user disposes the metal and it is either melted down using as little as 5% energy or put in a landfill.

**Environmental consequences:** when the ore is dug up from the ground it uses a lot of energy and there is a lot of fumes going into the atmosphere and there is also a lot of energy used when they convert it into metal. When it is left in a landfill for a long amount of time it damages the earth.



**Thermoplastics** it is the most common plastic because it can be reshaped when reheated. Common thermoplastic names, PET, HDPE, PVC AND LDPE.

**Examples and Common Uses:** Bottles, food containers, bowls, buckets, pipes, window frames, flexible hoses, toys and transparent packaging.



**Thermosetting Plastics** . The chemical polymers that make up these types of plastics bond permanently when heated and set hard as they cool.

**Examples and Common Uses:** surface coatings (Epoxy resin) laminates for work surfaces, tableware (melamine formaldehyde). saucepan handles and cheap electrical fittings (phenol formaldehyde) car parts, glass reinforcing (polyester resin). adhesives, electrical fittings such as light switches urea (formaldehyde).



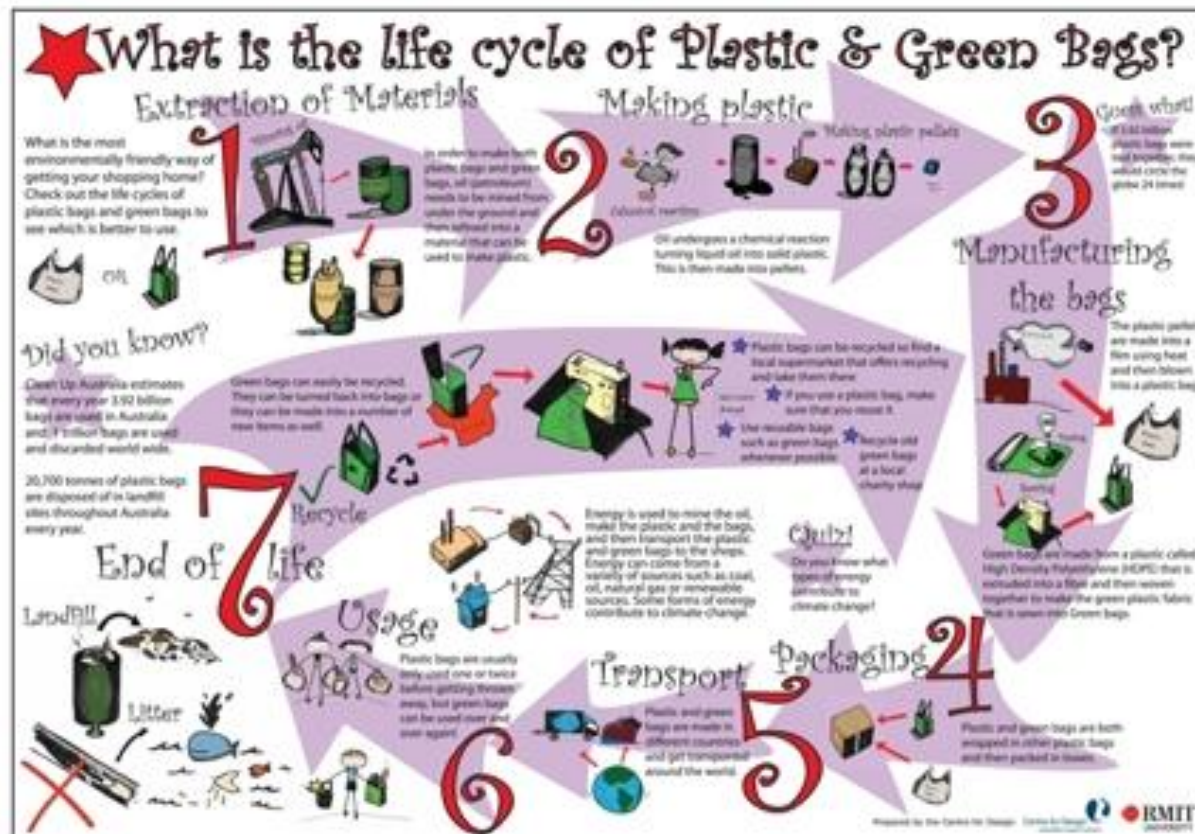

**Life cycle of Plastics:** Crude oil is extracted from the ground and then shipped or piped then the oil is refined to produce plastic. The product is then made and sent to the retailer and distributed to the shops, when it is disposed it is then recycled and eventually sent to landfill.

**Environmental consequences:** One of the positive characteristics of plastic is the fact that it is durable. Unfortunately, this is not a positive characteristic when it comes to the environment. The fact that plastic is durable means it degrades slowly. In addition, burning plastic can sometimes result in toxic fumes. Aside from trying to get rid of plastic, creating it can be costly to the environment as well. It takes large amounts of chemical pollutants to create plastic, as well as significant amounts of fossil fuels.



**GRP** consists of strands of glass fibres that are coated in polyester resin.

Common Uses: sailing boat. Kit car

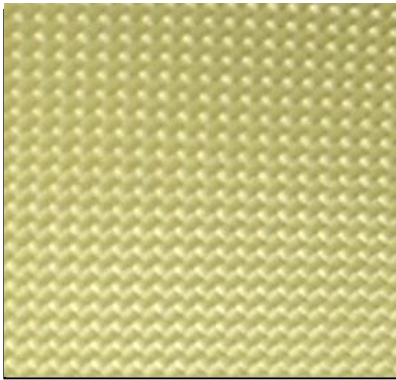

**Kevlar** is similar to carbon fibre matting. Very strong plastic material woven to form a mat.

Common Uses: Kevlar is used make items as badminton and tennis rackets, helmets and bullet-proof vests. Body armour



**Carbon Fibre** is reinforced plastic – similar to GRP. Strands of carbon that are coated in polyester resin – used in high performance products.

Common Uses: track bike tennis racket



## Polymorph

Common Uses: Producing models for ergonomically designed handles.



## Thermochromic Pigments

Common Uses: Russle Hobbs make a kettle that changes colour as it boils. Tommy Tippee produce a range of baby feeding products that change colour to warn you if the baby's food is too height.



## Shape Memory Alloys

Common Uses: 'Memo flex' spectacles are made from a shape memory alloy and have the ability to return to their original shape even when they have been very badly bent.



## Nanomaterials

Common Uses: because they are light, stiff and strong. A good example is on jet ski hulls. This reduces the weight and also gives a high gloss finish that reduces surface tension on water and increases performance.



## Knock Down Fittings:

Knock down fittings is when products are disassembled so that they can be flat packed to be able to fit in some ones car or portable for them to take home and build themselves. They are designed to be built with a screwdriver or a Allen key which is often supplied by the pack. They are useful for joining metal to timber and sometimes plastics.

## Examples and Uses:

Cam lock- This is a large thread on the screw is designed to grip well in chipboard and Mdf. Turning the cam, pulls the parts together.

Worktop Connector- Fitted underneath worktop. Tightening the nuts with a spanner pulls the worktops together.



## Other Fittings:

This is a variety of fixtures used for moving parts on products.

## Examples and Uses:

Magnetic catch- simple to fit but visible when the door is open.

Bolt- often used to fix one pair of doors or keep draws shut.

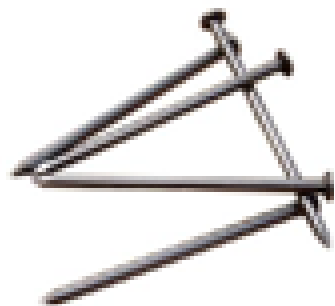

**Nails:** nails are easy and quick to use with a hammer. nails are mostly made by steel. other materials stainless, copper and aluminium. some mild steel nails are available with a galvanized finish for use outdoors.



**Screws:** wood screws are used to join together a variety of materials. There are different shapes and sizes of screws

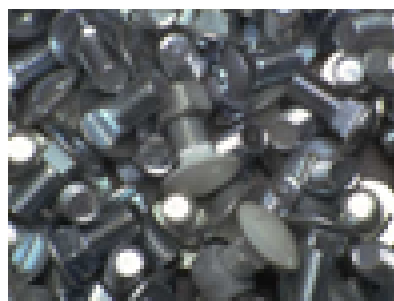

### **Nuts and Bolts:**

Usually used for fixing metals together. Are non permanent. They come in various shapes and sizes dependant on their task.



**Rivets:** ways to join metal sheets together without having use of heat





## What are they?

A substance used to stick things together

**Preparation: All adhesives need the material to be clean, dry and free from oil and dust if they are to achieve their maximum grip. Some areas may need to be covered in masking tape to prevent the glue from spreading.**

**Some adhesives require the joint to be keyed. This means that the joint should be made roughly (usually done with an abrasive paper)**

Name	Material	Drying Time	Use
Hot Glue stick (glue gun)	Wood, metal, plastic.	On cooling.	Is waterproof but weak, but only suitable for modelling or temporary fixings. It is heated in a special gun and comes out from the nozzle.
PVA	Wood	4-24 Hours	Gives a strong joint. It comes in a liquid form.
Liquid Solvent Cement 'Tensol'	Thermoplastic	10 Minutes	It is waterproof and gives a medium strength joint. It comes in a liquid form. The joint needs to be held together while the glue dries.
Synthetic Resin 'Cascamite' 'Extramite'	Wood	6-8 Hours	Is waterproof and gives a strong joint. It comes in a powder form. The joints must be held together while the glue dries.
Contact Adhesive 'Evostick'	Wood, metal, plastic.	INSTANT	It is waterproof and gives a medium strength joint. Ideal for plastic laminates to chipboard for kitchen worktops. It comes in a liquid form.
Epoxy Resin 'Araldite'	Wood, metal, plastic	½ - 6 hours	Is waterproof and gives a strong joint. Equal amounts of resin and hardener are mixed together and applied with a spreader. Must be held together whilst glue dries.
Cyanocrylate 'super glue'	Wood, metal, plastic	Instant	Is waterproof and gives a medium joint. It comes in a liquid form.



### **Preparing a Wooden Surface:**

Make surface and edges flat (plane and sander)  
Work your way through the grades of paper from course to fine.

Remember to sand with the grain.

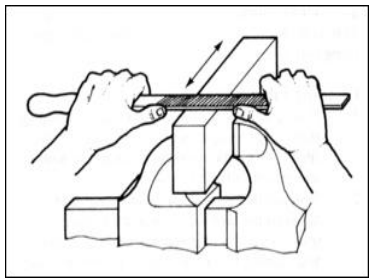

### **Preparing a Metal Surface:**

Make surface and edges smooth (draw filing)

Clean the surface – emery cloth

Clean with white spirit

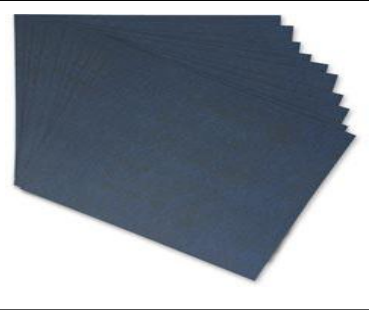

### **Preparing a Plastic Surface:**

Keep on any protective plastic as long as pos

Draw file the plastic

Use abrasive paper – wet and dry



### **Abrasive Papers:**

Abrasive papers are used for finishing all types of materials and come in a variety of grades. The higher the number the finer the grade.



## Intro:

Finishes improve the products look.

Protect materials from being damaged.

## Finishes for Metal:

**Paint:** Oil based, water based, solvent based (most common). Primer applied then undercoat then top coat of paint (more if necessary).

**Lacquer:** Adds clear shine good protection. Solvent based in the form of spray with no brush strokes and fast drying.

**Plastic dip coating:** Adds colour & excellent protection. Metal is heated to 200 degrees & dipped into a bath of polythene then left to cool.

**Oil bluing:** Adds bluey/black colour to steel & some protection. Firstly heated to 700 degrees then plunged into an oil bath & cooled.

**Anodising:** An industrial process involving electrolysis. Adds vivid colour to aluminium & excellent protection.

**Plating:** Coating metal with another metal gives excellent protection also involves electrolysis.

**Galvanising:** Coats metal with another metal gives excellent protection. Involves dipping steel into molten zinc



## Finishes for Wood:

**Wax:** Beeswax & silicon polish. Adds shine & some protection. Solid, rubbed on & buffed when dried.

**Oil:** Teak oil, Danish oil, linseed oil (most common). Shine & some protection. Liquid, rubbed on with cloth.

**Stain:** Changes wood colour & little protection. Added with cloth. When dry it needs to be sealed with sealer or varnish for shine & protection.

**French Polish:** Adds deep shine & some protection.

**Sealer:** MDF sealer most common. Shine & good protection. Liquid applied with brush.

**Varnish:** Polyurethane & acrylic. Shine & good protection.

**Paint:** Oil based most common. Adds colour (mat, silk, gloss) good protection.

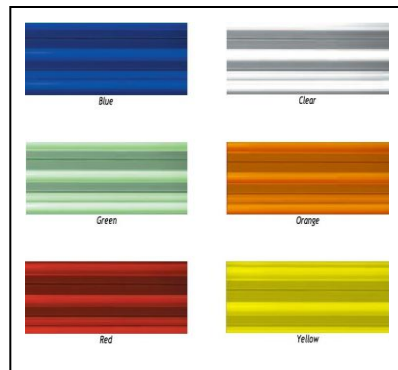

## Finishes for Plastic:

They are usually self coloured and finished. They are only required to be polished.







<b>Area to Revise</b>	<b>Revised</b>
Workshop Safety	
Control of Substances Hazardous to Health (COSHH)	
Hand Tools	
Power Tools	
Marking Out	
Joining Wood	
Joining Metal	
Casting	
Forming Wood	
Deforming Metal	
Moulding Plastics	
Computer Aided Manufacture (CAM)	
Quantity Production	





**Workshop Safety?** Most accidents that in are caused by human carelessness. You must always concentrate on working safely, both for your safety and that of others using the workshop. One brief lapse of concentration could lead to an accident that changes your life, or that of a friend, for ever. It is your responsibility to behave in a mature and correct manor.





**Potential Hazards:** wear goggles when sawing, sanding or drilling. Wear heat proof gloves Handling hot or sharp materials. Wear apron for General workshop

Operation	PPE	Hazard	Safety Symbol
Drilling, sanding, welding	Goggles, welding visor	Dust, swarf or sparks	
General workshop activities	Apron	Clothing may get caught in machinery or chemicals can spill onto clothing	
Handling hot/sharp	Heat proof gloves, leather apron steel masks.	Burning hands/ fingers when working with hot materials.	
Using machinery	Ear defenders	Damaged hearing after repetitive or continuous loud noise.	
Sanding, applying a finish, using adhesive	Face mask, latex gloves	Lung damage from inhaled dust or fumes	
Carrying or installing equipment	Stout shoes with toe protection	Damaged or crushed toes and feet caused by falling materials or equipment.	



**COSHH:** A set of regulations that ensure hazards are controlled so as not to affect someone's health (e.g. – hazardous substances)  
 If these hazards such as ones you may find in a workshop are not controlled properly then effects such as skin irritation, lung damage, cancer etc may effect the users.

**Reducing Risks with control measures:** Replacing high risk substances with safer alternatives, using substances in a safer form (gels instead of liquids) providing ventilation, storing substances in secure locations.

Symbol	Meaning	Hazard	Control Measure
	Flammable	Catches fire easily	Use with care in ventilated areas. Keep away from naked flames.
	Toxic	Poisonous – if inhaled, swallowed or if penetrates the skin	Only use with PPE and in very small quantities. Dispose with care.
	Harmful	Less dangerous than toxic but can cause inflammation.	Only use with PPE and in very small quantities. Dispose with care.
	Corrosive	Will attack and destroy living tissue including the skin and eyes.	Avoid large quantities. Use with correct PPE in a tray to avoid spills
	Irritant	Not corrosive but can cause reddening, irritation or blistering	Avoid large quantities. Use with correct PPE in a tray to avoid spills



**Hand Tools:** many of the hand tools you use in the school workshop have evolved over hundreds of years. Craftspeople through the centuries have developed the ability to use these simple tools to create both beautiful furniture and buildings. Only some hand tools are covered on these pages but they should help you understand the importance of using common tools safely and correctly.

**Sawing:** there are a number of saws available that are used for wasting and shaping materials. The teeth of the saw are slightly bent outwards, which provides the necessary clearance to prevent jamming but consequently the width of the cut is wider than the thickness of the blade.

Tool	Material	Process
Tenonsaw	wood	The blade is stiffened to make straight cuts. It is used to cut pieces of wood to the correct length and wasting unwanted material.
Coping saw	Wood and Plastic	The thin blades allow you to make curved cuts. The blade is held in tension by spring steel frame with the teeth pointing backwards towards the handle.
Hack saw	Metal and Plastic	Hacksaws have finer teeth and are mainly used cutting metals. The blade of the hacksaw has the teeth pointing towards the front and is tensioned by the screw at the front of the hacksaw.
Junior Hacksaw	Metal and Plastic	This is a smaller version of the hacksaw with both a smaller blade and lighter metal frame.

**Shearing:** materials can be shaped using a variety of hand tools that use some form of cutting action to remove material. Keeping tools sharp is important, as well as using them correctly, if a quality finish is to be achieved on the material. Wood and metal chisels use a basic wedge cutting action while planes use a similar action but the blade is held at a particular angle. Files use rows of teeth to remove small particles of material called filings.



**Shaping:** Materials can be shaped by a variety of hand tools that use some form of cutting action to remove material. Keeping tools sharp is important as well as using them correctly.

Tool	Material	Process
Wood Chisel	Wood	Used for removing waste as well as shaping.
Cold Chisel	Metal	Much harder than wood chisel. Always wear safety goggles
File	Metal, Plastic	Used for shaping metals and some plastics. Used in 2 actions – cross and draw filing.
Plane	Wood	Used to reduce the size of the material by shaving the wood. Planing across the grain can cause splitting of the wood.

**Drilling:** As well as making holes in materials, drilling can also be a quick way of removing waste materials quickly.

**Holding:** There are many tools designed to hold materials securely and safely. They allow you to concentrate on working with tools with greater control and to avoid coming into contact with sharp cutting edges. It is important to use holding tools such as clamps and vices for your own safety.

**Power Tools:** A power tool is a tool powered by an electric motor, an internal combustion engine, a steam engine, compressed air, direct burning of fuels and propellants, or even natural power sources like wind or moving water.



**Pillar Drill:** a pillar drill is a fixed style of drill that may be mounted on a stand or bolted to the floor or workbench.

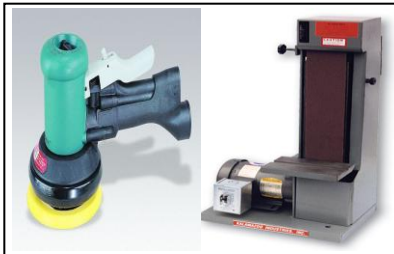

**Belt sander and disc sander:** A belt sander is a machine used to sand down wood and other materials for finishing purposes. A sander is a power tool used to smooth wood and automotive or wood finishes by abrasion with sandpaper.

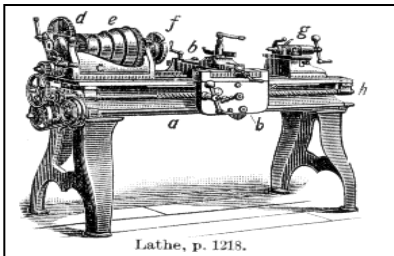

**A lathe** is a machine tool which rotates the work piece on its axis to perform various operations such as cutting, sanding, knurling, drilling, or deformation with tools that are applied to the work piece to create an object which has symmetry about an axis of rotation.



**Band Saw:** A band saw is a power tool which uses a blade consisting of a continuous band of metal with teeth along one edge to cut various work pieces.





**Scroll Saw:** used to cut intricate curves. Use blades similar to coping saws. Different blades are available for a selection of different materials and tasks.



**Milling Machine:** use rotating multi toothed cutter to shape materials using a high level of precision. The bed can be moved in three separate directions.



**Mortising Machine:** Less common in schools but is a quick and accurate method of producing multiple mortise joints. The machine uses a drill bit held inside a specialist square and hollow chisel. The drill bit removes most the materials while the chisel ensures all the edges are straight and clean.

## Hand Held Power Tools:



**Cordless Drill:** Easy to use and lightweight. Can be used as a screwdriver due to them having a clutch setting. Most drills are now designed more ergonomically with better balance and soft grip handles.

## Hand Held Power Tools:



**Jigsaw:** can be used for making straight cuts or for curved shapes. There are various types of blades which are suitable for most cutting materials. Work must be held securely due to vibrations caused.



**Palm Sander:** Many have quick change facility for the abrasive pad which comes in various sizes and grades. Ergonomically designed to fit the users hand and often come with soft grip handles.



**Router:** with the help of a guide they can be used to produce slots, cut shapes following a template or to produce an edge decoration on wood. Can be mounted in a specialist table – like the one we have in the workshop.



**Biscuit Jointer:** provides an easy way of joining two pieces of wood together. Works by cutting crescent shaped slots into both items and then bringing the two pieces around a elliptical shaped piece of wood which creates a joint.

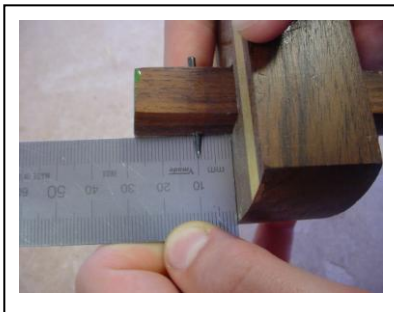

**Marking Out:** majority of marking out is completed by placing lines directly onto the surface of the material. Very important as makes work accurate and stops materials being wasted.

**Marking Tools:** Choice of marking tools is determined by the material.

Tool	Notes	Material
Pencil	Best tool to use on a variety of materials. Softer the pencil – the more easier it is rubbed out. The harder the pencil – the more accurate the lines.	Wood, Acrylic, paper, card
Chinograph pencil	Lines can be easily removed but lack crispness	Plastics
Marking knife	Make a small cut into the material and can give a clean edge when sawing or chiselling. Mistakes can be difficult to remove.	Wood, Card
Scriber	Used when a thin an accurate line is required. To help see the line they are used with engineers blue.	Metals
Spirit pen	Markers come in different thicknesses, Thin pens should be used where accuracy is required. Aluminium sheet is often marked out using a marker as it can be removed by solvents.	Plastics, Aluminium

**Straight Lines:** placed onto materials will be parallel to, at an angel to, or square (90) to an edge.

**Curves and Circles:** Marking circles and curves accurately dependant on the tool you are using not moving or slipping on the surface.

**Templates:** and stencils are normally used to mark out odd or complex shapes, particularly if the process is to be repeated several times.

Tool for Making Straight Lines	Notes	Material
Ruler	Available in different lengths – have a zero end to measure easier.	Wood, Metal, Plastic, Card and Paper
Try Square	Used to mark right angles to an edge.	Wood, Plastic, Metal
Adjustable Bevel	Can mark lines at different angles	Wood, Plastic, Metal
Mitre Square	Used to measure 45 degrees angles	Wood, Plastic, Metal
Marking Gauge	Used to mark parallel lines on wood. Its is adjustable and used along the grain.	Wood
Odd-leg callipers	Similar function to a marking gauge	Metal, Plastic
Tool for Making Curves and Circles	Notes	Material
Spring Dividers	Used to make accurate circles and arcs	Metals, Plastics
Compass	Different versions allow a selection of pens and pencils to be used	Wood, Paper, Card, Plastics
Centre Punch	Used to make a dot for a drill to sit accurately into the material so it doesn't move on impact.	Metals and Some Plastics

## Joining Wood:

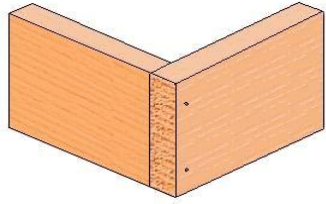

**Butt joints:** The **butt joint** is a very simple joint to construct. Members are simply docked at the required angle (usually 90°) and required length. One member will be shorter than the finished size by the thickness of the adjacent member.

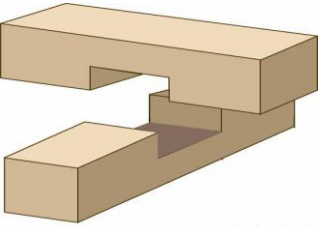

a **lap joint** is a technique for joining two pieces of material by overlapping them

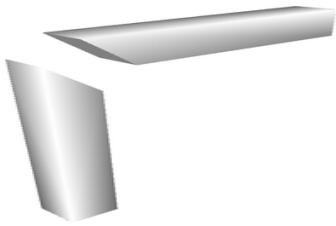

A **mitre joint** sometimes shortened to mitre, is a joint made by sawing each of two parts to be joined, usually at a 45° angle, to form a corner, usually a 90° angle



The **finger joint** (also known as a comb joint) is a woodworking joint made by cutting a set of complementary rectangular cuts in two pieces of wood, which are then glued.

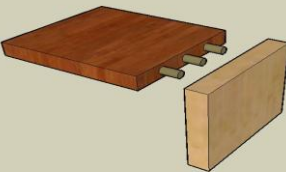

A **dowel** is a solid cylindrical rod, usually made of wood, plastic or metal.



## Joining Metals:



**Soft Soldering:** this is used as a quick method of joining copper, brass and tinfoil when little strength is required in the join. It is also used for fixing electronic components into a circuit. The filler rod or solder melts at a relatively low temperature and traditionally was mixture of tin and lead but due to the health risks of using lead has now been replaced by an alloy of tin.



**Hard Soldering:** hard soldering, also known as silver soldering, uses a filler rod that is an alloy of silver mixed with copper and zinc and melts at temperatures between 600°C to 800°C. This range of temperatures enables work to be joined in several stages with the highest melting point being used first through to the lowest melting point solder called 'easy-Flo' this prevents earlier joints coming apart when applying heat for later joints.

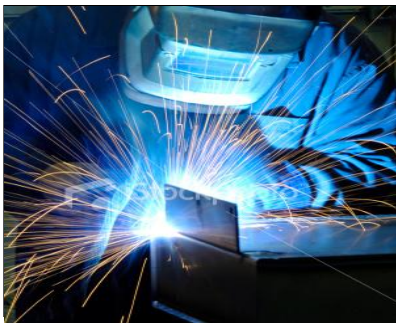

**Welding:** Welding is a process for joining similar metals. Welding joins metals by melting and fusing. Oxy-acetylene and electric arc. Both of these fuse steel together to produce a very strong joint. Oxy-acetylene welding uses acetylene burned in oxygen to produce a flame at approximately 2,500°C. Using the heat of the flame on the joining edges melts the metals and a filler rod is introduced to help fuse the materials together by melting into a pool that sets on cooling. In electric arc welding the heat required to melt the metals is provided by a current passing through a gap (arc) between the filler rod (electrode) and the metal. The electrode is coated in a flux to prevent the joint becoming oxidised.

**Casting** is a process that involves pouring molten metal into a shaped mould. This is used to produce a range of shapes that would normally be difficult to make from a single piece of material. Plastics and concretes can be cast but is more suited to metals.



**Aluminium Casting:** Sand moulds are usually used to produce complex metal shaped castings. Wide variety of formers but usually flat backed – simplest and/or split pattern – complex shapes. **See stages Below.**



**Pewter Casting:** Alloy with a melting point that is low enough to melt in school. Moulds can be made out of MDF. Due to low melting point Pewter sets quickly too.

### A METAL CASTING POURED IN A SAND MOLD

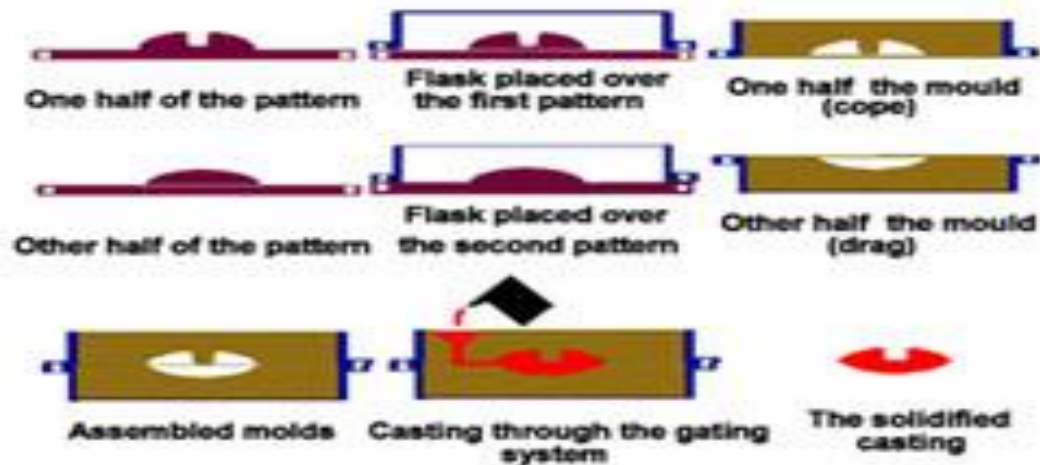

## Forming Woods:

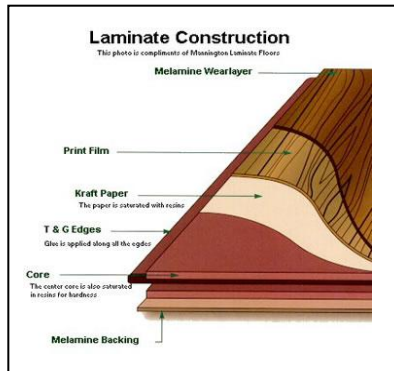

**Laminating:** Apart from creating a material that is often longer or thicker than what is available, laminating is used to produce shaped materials with improved properties – or to obtain shapes that can't be cut from one piece of material. Thin strips of wood are deformed and bent into curved shapes using a former and then they are glued together.

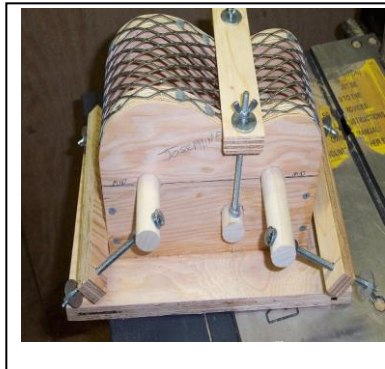

**Formers:** are used to produce laminated shapes. The surfaces of the former must be smooth and there must be an allowance for the thickness of the laminates. The former can be lined with rubber or cork to help with slight irregularities. The former would be held together with sash clamps until set.



**Wood Turning:** Usually uses a lathe to create objects such as chair legs, bowls, lamps and patterns for either sand casting or vacuum forming.

**Deforming Metals:** Forming or forging shapes in metal is often considered to be both quicker and more economical than machining metals. Most are carried out hot to avoid the risk of work hardening and to ensure that they are easier to work into the required shape. Forging is a highly skilled process that has been used for centuries.



**Hot Forming Metals:** used to produce very strong components due to the structure of the material that is being refined. The most common metals that are hot formed are mild and tool steel. Process carried out with a hammer and anvil by hand.

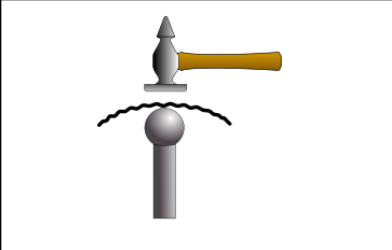

**Cold Forming Metals:** Requires a material that has a high degree of malleability. Copper, brass and aluminium are usually used. Constant hammering causes work hardening and therefore needs regular annealing.



**Cold Working Sheet Metals:** using aluminium allow you to produce complex shapes such as cones, boxes and trays. Before starting your work you should practice with card to establish sizes, position of joining flaps and bend sequence.

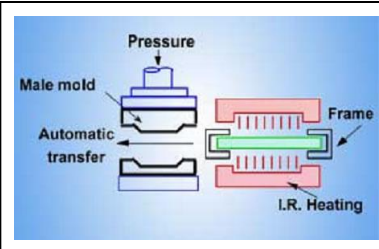

**Press Forming:** used to make strong everyday components such as car panels, components of an Ipad by pressing thin sheets of metal into a shell shape. Material is annealed and placed in a giant die with loads of pressure applied.



# Moulding Plastic



## Vacuum Formed Products:

Most thermoplastics soften and become pliable at around 160 C, this makes it easy to mould into the required shape using fabrication techniques. There is no loss or gain when deforming plastics. Expensive moulds are used for large scale production.

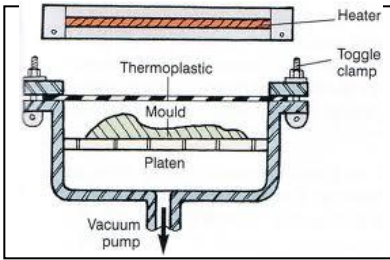

## Vacuum Forming:

This is a method of forming plastic that is common in schools used to produce trays, cartons, lids ect. This is used in batch or mass production to make food packaging within the packaging industry. It is done by heating a clamped sheet of thermoplastic until soft, air is then extracted so that the plastic is sucked down forming a mould. The mould must be shaped so that it easily comes off it is then tapered so that it has a smooth finish and smoothed edges.

Description	Illustration
Mould is placed inside a machine where the plastic sheet is clamped to the top of the box using a toggle clamp. The heater is moved into position to heat the plastic until it softens.	
The heater is pushed back and the mould located on, the platen is then lifted into the hot plastic before the vacuum pump is turned on.	
The air between the mould and the softened thermoplastic is sucked out by the pump. The plastic will be forced down over the mould, creating a sharp definition.	
The sheet is unclamped from the frame and the mould is removed. Excess material around the moulding is trimmed off.	



## Line Bending:

Simplest method of forming thermoplastics. A strip heater that has a narrow opening allows heat to escape in a restricted area. This then heats and softens the plastic in a concentrated line. Acrylic is popular within schools it can be line bent but must be heated carefully as it can be blistered from overheating and might snap as its bent. By using formers or jigs you can increase the accuracy of bending certain angles, they also help to hold work still as it cools..



## Computer Aided Manufacture (CAM):



**Vinyl Cutters:** cut out complex shapes out of a variety of thin materials and are available in a range of sizes. Used to carry out work such as card modelling, packaging, and sign writing. They work in 2D and are easy to set up.



**CNC Milling Machine:** produce a variety of 2D and 3D components – commonly in materials such as brass, steel and alloys. Materials are held in a small vice or with double sided tape.



**CNC Lathe:** accurately manufactures a wide range of complex turned components from steel, brass and alloys and also plastic materials. Good for producing quantities of identical pieces.







**Laser Cutter:** Used for cutting and engraving in schools on materials such as paper, wood and plastics. Very accurate and easy to operate. Quite expensive to buy and must have sufficient extraction.

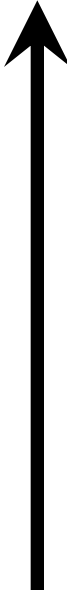

**3D Router:** Used to accurately manufacture a range of 2D and 3D components in wood, MDF, Foam and Plastics. Easy to set up and operate. Do require dust extraction to prevent fire and dust becoming air borne.

**Quantity Production:**  
Dependant on demand

Level Of Production	Description	Example	Equipment and Tooling cost	Labour Costs	Skill Level	Production Costs	Efficiency
<b>One - off</b>	<b>Most hand made</b>	<b>A sculpture – your own work</b>					
<b>Batch</b>	<b>Jigs used to create small batches</b>	<b>Table , stools</b>					
<b>Mass</b>	<b>Specialist equipment and workers for high volume</b>	<b>Car, light bulbs, nuts, screws, plastic containers</b>					
<b>Continuous</b>	<b>Not many are continuous</b>	<b>Various food items, steel, petrol.</b>					

**Scale of Production:** Dependant on demand products are made in a range of quantities from large scale mass production (screws, light bulbs etc) to one off product (bespoke furniture etc) Each level has advantages and disadvantages.



**Drilling Jig:** When a number of holes in identical places / components a drilling jig saves time and increases accuracy. The number of repeated operations determines what material that the jig will be made from.

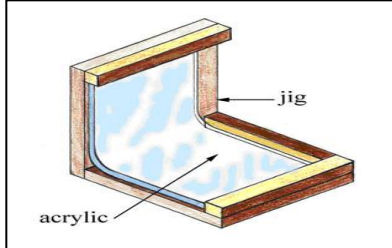

**Bending Jig:** used to make bends in a number of materials to improve accuracy and speed of operation. The material being bent and the temperature will determine the material the jig will be made from.



**Templates:** These should be easy and simple to use and can be made from paper, card or sheet materials. It should save time and be made from a material that is hard enough for repeated use.



**Vacuum Forming Mould:** can be made from a wide variety of materials that are resistant to low heat and provide a required level of surface finish (wood, card, clay) Complex shapes must taper slightly for ease of removal.

<b>Area to Revise</b>	<b>Revised</b>
Levers	
Linkages	
Types of Motion	
Cams	
Belt and Pulleys Systems	
Chain an Sprocket Systems	

**Mechanical Systems** are a vital part of our everyday lives. The spoon that you ate your cereal with this morning is a very simple example of a mechanical component. The bus that may have brought you to school is an example of a very complex mechanical system.

### Levers:

A lever is a bar that can be used to provide mechanical advantage. Levers are classified depending upon where the pivot point is placed. This also affects how the lever works.

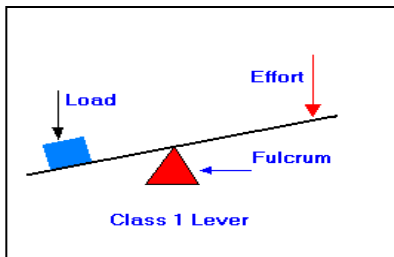

**First Class Lever:** The pivot is placed between the effort and the load. The further the effort is away from the pivot point the greater the mechanical advantage.

E.g.. See saw

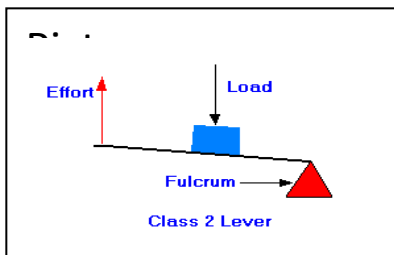

**Second Class Lever:** The pivot point is placed at one end of the lever and the effort is at the other, leaving the load in the middle. E.g. A wheelbarrow – the longer the handles the easier to use

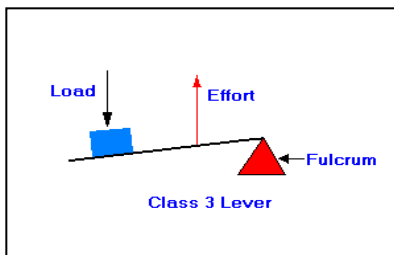

**Third Class Lever:** The pivot point is placed at one end of the lever and the load is at the other leaving the effort in the middle. E.g. A spade.



**Mechanical System:** An assembly of mechanical components that form a machine

**Mechanical Component:** A mechanical part of a larger system or product.

**Mechanical Advantage:** The way in which a machine makes things physically easier to do,

### Linkages:

A linkage consists of a number of levers connected together to form a mechanical system.

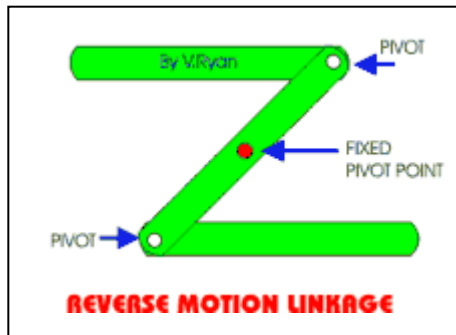

### Reverse motion linkage:

When the top lever is pulled to the left the bottom lever is pushed to the right. The direction is reversed.

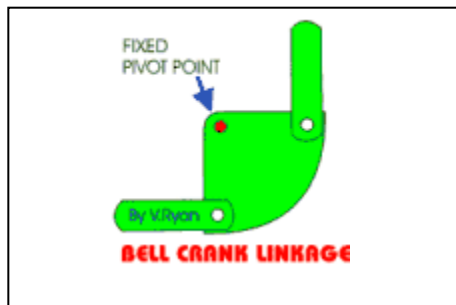

### Bell crank linkage:

When the bottom lever is pulled to the left the top lever moved down. The direction has been turned through 90 degrees.

# Types of motion:

**Rotary Motion:** Easiest to understand – Moving in a circle like a wheel of a bike.

**Linear Motion:** When a component is moving in a straight line – Like a train on a track.

**Reciprocating Motion:** When a component is moving backwards and forward in a straight line – think about a blade on a fret saw or jigsaw.

**Oscillating Motion:** When a component is moving backwards and forwards in an arc. Think about a swinging pendulum on a grandfather clock.

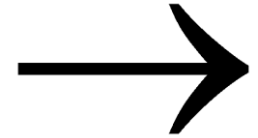

**Cams:** A shaped disc that rotates on a shaft. As it moves a follower moves up and down responding to the shape of the cam.

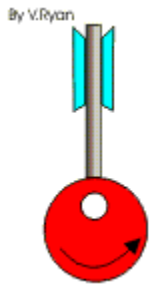

Circular Cam

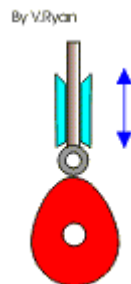

Pear Cam

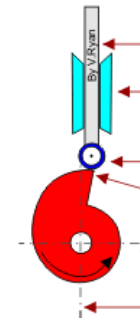

Snail Cam

# Transferring power and movement

Is very common in many mechanical systems. Electric motors generate rotary motion and this movement needs to be controlled and transferred to where it is required.

**Belt and Pulley System:** transfers rotary motion from one shaft to another. A pillar drill will have a belt and pulley system. Using different sized pulleys you can alter the speed that the shafts rotate. Small pulley driving a large pulley will decrease the speed.

**Chain and Sprocket system:** is another method of transferring rotary motion from one shaft to another. A bicycle has a chain and sprocket system. Using different sized sprockets you can alter the speed. They are more expensive than belt and pulleys but can transfer greater amounts of force and more reliable,

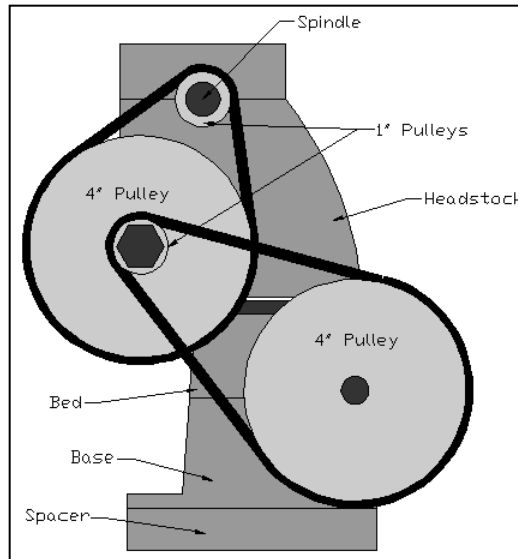

**Belt and Pulley System**

**Chain and Sprocket System**



<b>Area to Revise</b>	<b>Revised</b>
Famous Designers	
The natural world and how it influences design	
Form and Function	
Market Pull and Technology Push	
Design Periods through History	
Social, Moral and Cultural Influences on Design	
Sustainability and Environmental Issues and how they affect designing	
Designing for Maintenance	
The role of the client, designer and manufacturer in designing a product	
How to analyse existing products	
How to evaluate your ideas	
How to plan for manufacturing a product	